

A family business owned by veterinarians for veterinarians since 1965  
1450 Van Buren Avenue, Loveland CO 80538  
©2014 Jorgensen Laboratories, Inc.



800.525.5614  
jorvet.com

JORGENSEN LABORATORIES, INC.

2014

# JORGENSEN LABORATORIES, INC 2014

The collage features a variety of veterinary products and services. At the top left is J-LUBE, a general lubricant. Next to it is J-JELLY. To the right are Oxyhood and EZ Tie. Further right is KITTY KOLLAR and C Muzzle. Below these are icare tonometer VET, VetCam, Hercules, and HENKE SASS WOLF. The middle section includes VetMedCare, BUSTER, and SAM SPLINT. Below that are TonoVet Tonometer, MB SPINAL BRACE, EYE SAVER, and WAXEATER. The bottom section features Breathe Easy, rh, WARM BLOOD, KRUUSE, HAUPTNER, VET-R-SEM, BREATHE SAFE, HEMASTOP, SQUEEZE TEST, Jackson Cat Catheter, LAB LITER, Cloud Nine, Soft-E-Collar, B | BRAUN, WALKABOUT harnesses, Litter Magnet, QUICK SPLINT, Dip Quick Stain, Colorado Landing Cots, and HALTI.

Bringing the brands of quality  
to the veterinary profession

## Jorgensen Laboratories, Inc. (JLI)

### JorVet

2014

**“Veterinary Owned and Family Run Business Since 1965”**



Irvin G. Jorgensen, Founder

JorVet is nearing the half century mark in providing veterinarians with the very best in veterinary instruments and equipment. The company is proud to have reached this milestone and recognizes that it would not have been possible without the support of the veterinary practitioner.

The new 2014 JorVet catalog is our largest ever! This catalog offers thousands of veterinary products that are needed regularly in modern veterinary practice. Within these pages you will find over 50 new and innovative products to enhance your practice. There are new products for the large and small animal practitioners. The small animal practitioner will want to see what's new in the fields of physical therapy, patient comfort and holistic medicine. Patient comfort has become so important in the delivery of veterinary healthcare and the JorVet patient comfort products used in your clinic will be noticed by your clients and appreciated by your patients. The Orthopedic section of the JorVet catalog has also increased. This is the largest section in the catalog and offers additional new selections of locking plates and screws, instruments and splints plus everything needed for various CCL repair techniques. Laser therapy is becoming the recognized standard of high end care for pain management and rehabilitation. JorVet offers the latest in Class 3 and 4 Laser Therapy. These lasers have been designed for safe and effective use and the unique modular architecture allows for flexibility and growth.

JorVet offers experienced veterinary technical support and skilled sales representatives to detail sophisticated equipment and to assist your clinical staff in understanding and using this equipment. Please visit the JorVet website – [www.jorvet.com](http://www.jorvet.com) for news, product information and You Tube videos on a wide range of veterinary surgical procedures. Please contact us and let JorVet help you with any of your equipment needs.

**Buy with confidence – when you buy JorVet**





■ Suture & Suture Needles . . . . .	3–11
■ Syringes & Hypodermic Needles . . . . .	12–17
■ Obstetrical Instruments . . . . .	18–23
■ Artificial Insemination . . . . .	24–26
■ Protective Veterinary Apparel . . . . .	27–28
■ Teat Instruments . . . . .	29–31
■ Bovine Abdominal Surgical Instruments . . . . .	32–33
■ Castration/Spaying Instruments . . . . .	34–35
■ Equine Specialty Instruments . . . . .	36–41
■ Equine Dental Instruments . . . . .	42–51
■ Hoof Care Instruments . . . . .	52–57
■ Diagnostic & Restraint . . . . .	58–76
■ General Surgical Instruments . . . . .	77–91
■ Intravenous Equipment/Blood Transfusion Products . . . . .	92–114
■ Biopsy Instruments . . . . .	115–118
■ Genito-Urinary . . . . .	119–125
■ Anesthesia Equipment . . . . .	126–154
■ Small Animal Dental Instruments . . . . .	155–172
■ Ophthalmic Instruments . . . . .	173–178
■ Orthopedic Instruments . . . . .	179–246
■ Ear Instruments . . . . .	247–250
■ White Goods . . . . .	251–260
■ Large Animal Equipment . . . . .	261–266
■ Small Animal Specialties . . . . .	267–276
■ Necropsy/Postmortem/Urns . . . . .	277
■ Mineral & Vitamin Gel Cartridges . . . . .	278
■ Nail Trimmers . . . . .	279
■ Clinical Laboratory Equipment . . . . .	280–308
■ Small Animal Stomach & Feeding Tubes . . . . .	309–312
■ Catheters . . . . .	313–314
■ Large Animal Stomach & Feeding Tubes . . . . .	315–317
■ Grooming Aids . . . . .	318–319
■ Avian Equipment . . . . .	320–321
■ Stainless Steel Ware . . . . .	322–323
■ Ultrasonic Cleaning Systems . . . . .	324
■ Surgical Drape Material . . . . .	325–328
■ Surgical Monitors . . . . .	329–330
■ Electrosurgery . . . . .	331–333
■ Instrument Storage & Sterilization . . . . .	334–358
■ Surgical Drains . . . . .	339–340
■ Animal Identification . . . . .	341
■ Surgical Apparel . . . . .	342–345
■ X-Ray Accessories . . . . .	346–350
■ Anatomical Models . . . . .	351
■ Suction/Aspiration . . . . .	352
■ Scales . . . . .	353–354
■ Cryosurgery . . . . .	355–356
■ Pharmacy Aids . . . . .	357–364
■ Physical Therapy . . . . .	365–375
■ Patient Comfort . . . . .	376–386
■ Medical Seating . . . . .	387
■ Safety & Biohazard . . . . .	388–389
■ Holistic Medicine . . . . .	390–391
■ Therapeutic Laser Therapy . . . . .	392–393
■ Behaviour Training . . . . .	394–395, 402
■ Pet Cremation/Burial . . . . .	396–400
■ Jewelry . . . . .	401
■ Index . . . . .	403–419
■ Conversion Chart . . . . .	424

**Braun Surgical Suture.** For over 45 years Jorgensen Laboratories has made surgical suture from B.Braun of Germany available through distributors to all veterinary practitioners in the United States. Surgical sutures by B.Braun are recognized throughout the world for their outstanding quality. B.Braun makes use of the latest sterilization techniques and a quality control that is unsurpassed in the selection of the finest quality suture available.

B.Braun, founded in 1839, made its first important contribution to the wound closure field around the turn of the century, when it introduced sterile catgut. This catgut suture provided surgeons, for the first time, with a sterile, absorbable material which was a major advance in the surgical closing of wounds.

B.Braun has continued this tradition with the development of the cassette pack which revolutionized packaging of continuous length suture. The cassette was designed specifically with the needs of the veterinarian in mind, and when combined with the stainless steel cassette rack makes an attractive and convenient unit that provides the complete range of surgical sutures at the surgeon's fingertips.

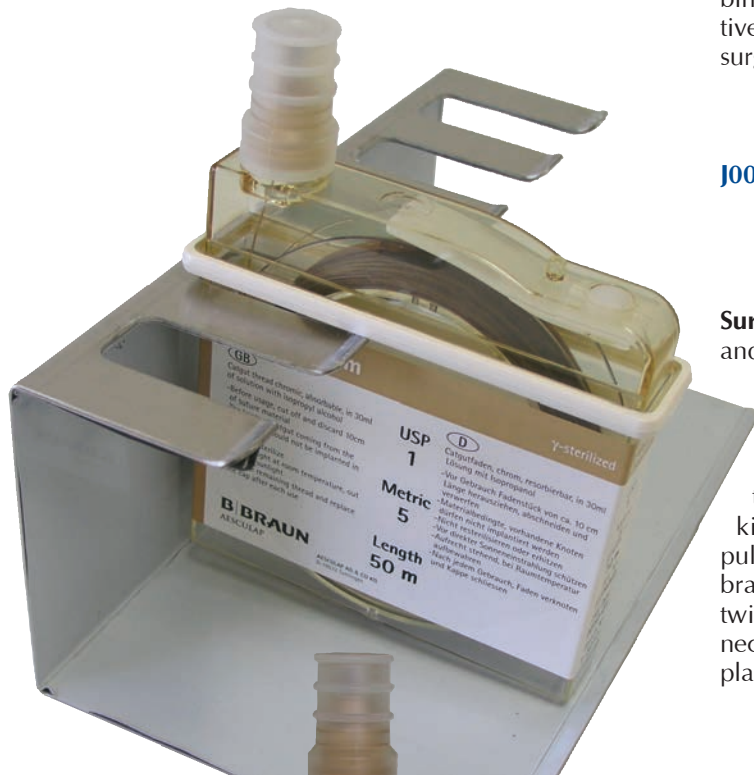

**J0091r5 Suture Cassette Rack.** Stainless steel. Heavy-duty model. Cassettes lock into place and cannot slip out. Holds 5 cassettes.

**Surgical Sutures in Cassette Packs.** A special stainless steel and sterilization dispenser rack devised for storing up to 5 cassette packs facilitates easy and quick dispensing of the suture material.

The suture thread is wound evenly on a large reel. The great advantage of this reeling device lies in the fact that the thread can be dispensed smoothly and without kinking, hence no more damaging and time-consuming pulling and smoothing of the thread. Furthermore, a built-in brake impedes the threads from slipping back and getting twisted. A tightly closing rubber stopper inside the cassette neck, as well as an additional seal and an outer autoclavable plastic cap, guarantee sterility of the contents.





**J0091c Catgut Medium Chromic.** Manufactured under continuous supervision from selected materials processed to high quality standards. It is accurately gauged and evenly chromed. High knot-pull tensile strength. Good knot-holding ability and exceptionally good handling qualities. Sterilized.

<b>J0091c40</b>	4/0 USP	—	50m (164') L.
<b>J0091c30</b>	3/0 USP	—	50m (164') L.
<b>J0091c20</b>	2/0 USP	—	50m (164') L.
<b>J0091c0</b>	0 USP	—	50m (164') L.
<b>J0091c1</b>	1 USP	—	50m (164') L.
<b>J0091c2</b>	2 USP	—	50m (164') L.
<b>J0091c3</b>	3 USP	—	50m (164') L.
<b>J0091c4</b>	4 USP	—	25m (82') L.
<b>J0091c6p</b>	6p USP	<b>Non-Chromic.</b>	25m (82') L.

**J0091 Braunamid.** Suture consists of a large number of fine twisted strands covered by a smooth, seamless, homogeneous polyamide cover. Because of its polyfil construction, Braunamid thread is considerably more flexible than the monofil sutures. Knot-pull tensile strength substantially exceeds USP requirements. Knot-holding ability is excellent because of its inner polyfilament structure. Non-capillary. Sterilized. Braunamid meets or exceeds all legal requirements set forth by the U.S. government.

<b>J0091040</b>	4/0 USP	<b>Medium Fine.</b>	100m (328') L.	
<b>J0091030</b>	3/0 USP		<b>Fine.</b>	100m (328') L.
<b>J0091020</b>	2/0 USP		<b>Medium.</b>	100m (328') L.
<b>J009100</b>	0 USP		<b>Heavy.</b>	75m (246') L.
<b>J009101</b>	1 USP	<b>Extra-Heavy.</b>	75m (246') L.	
<b>J009102</b>	2 USP		50m (164') L.	
<b>J009103</b>	3 USP		50m (164') L.	
<b>J009104</b>	4 USP		25m (82') L.	
<b>J009106</b>	6 USP		25m (82') L.	
<b>J009108</b>	8 USP	<b>Special.</b>	25m (82') L.	

**J0091s Stainless Steel Suture.** Monofilament, corrosion-resistant steel. Extremely high knot-pull tensile strength. Stitch holds for an unlimited period of time. Sterilized.

<b>J0091s40</b>	4/0 USP	—	50m (164') L.
<b>J0091s30</b>	3/0 USP	—	50m (164') L.
<b>J0091s20</b>	2/0 USP	—	50m (164') L.
<b>J0091s0</b>	0 USP	—	50m (164') L.
<b>J0091s1</b>	1 USP	—	25m (82') L.
<b>J0091s2</b>	2 USP	—	25m (82') L.
<b>J0091s3</b>	3 USP	—	20m (65') L.

**Braun Surgical Suture.** In addition to the well-known Braun suture cassettes and Braun needle-suture, we can now provide Braun suture in pre-cut lengths. White. Sterile. Individually packaged.

The Braun pre-cut length suture is available in Braunamid in two sizes:

- J0091pc0 Pre-Cut Braunamid.** 60". (not pictured)
- J0091pc3 Pre-Cut Braunamid.** 60". (not pictured)

**Safil Equine-Set.** An excellent choice for equine surgery when a braided polyfilament PGA suture is desired. Safil E-Set maintains 50% of strength at 18 days. For use in abdominal wall closures, fascia, muscle, and subcutaneous suturing.

		Catalog #	Size	Length	Sales Unit
<b>Safil E-Set</b>		<b>JB48080</b>	HR76-3/4	140cm	Each
<b>Safil E-Set</b>		<b>JB48515</b>	HRT485	140cm	Each

**Jorvet and Braun are Your Partners in Veterinary Surgery** providing a complete range of **Sutures** to cover any surgery need. These sutures are manufactured to the highest standard, set by the USP (United States Pharmacopia). When comparing various sutures, it is important to look closely at various parameters, like absorption rate, tensile strength during absorption, and knot holding strength to name a few. If time is taken to study these parameters, the choice will be Braun.

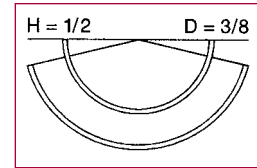

**When Ordering Specify:** **B#C**

- Needle Angle of Curvature:** **H:** 1/2-Circle OR **D:** 3/8-Circle
- Body Type:** **R:** ● Round-bodied OR **S:** ▼ Reverse cutting needle
- Needle Length:** Distance along the needle side between its point and its end, in millimeters.
- Wire Size:** **S:** Heavy body needle

Example: HR26 = 1/2-circle, round-bodied needle 26mm L.

*NOTE: See needle comparison chart on page 7.*

**Needle Sizing and Nomenclature.** Every manufacturer uses different terminology to describe their needles. The Braun system uses two letters to describe the needle shape followed by a number indicating the length of the needle.

**Needle Characteristics:**

● **Round Bodied Needle.** The body of this needle tapers down to a fine point, permitting minimum tissue damage. The needle is flattened in the middle, thus ensuring a firm grip for the needle holder. This needle is especially suitable for soft tissue.

▼ **Reverse Cutting Needle.** The triangular, reverse cutting needle is intended for suturing tough tissue. The three edges run over the entire length of the needle, and give the needle holder a firm grip.

**Needle-Suture Combinations by B. Braun.**

**Catgut Chromic.**

**1/2-Circle Round Bodied Needle.**

- HR22** 75cm 2/0
- HR26** 75cm 4/0, 3/0, 0, 1
- HR30** 75cm 3/0
- HR37** 75cm 3/0, 2/0



**1/2-Circle Reverse Cutting Needle.**

- HS26** 75cm 3/0
- HS37s** 75cm 2/0, 0



**3/8-Circle Reverse Cutting Needle.**

- DS24** 75cm 4/0, 3/0, 2/0, 0
- DS30** 75cm 2/0



**Braunamid, Black.**

**3/8-Circle Reverse Cutting Needle.**

- DS24b** 45cm 3/0
- DS30b** 45cm 3/0, 2/0, 0



1 x 12 Peel Packs.

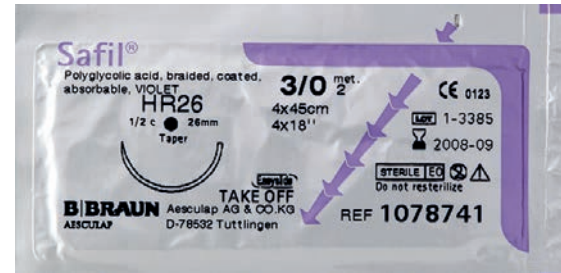

Clearly Labeled CE Information & Easy Product Identification.

Right: Sterile Double-Packaging with Transparent Peel Outer Pack.

Below: Tear-Off Opening System.



Right: Quick & Direct Gripping of Needle.



Left: Individual Removal of Pre-Cuts.

Below: Easy Disposal.



**Functional & Up-To-Date Packaging.** All Braun suture needles employ a unique packaging that allows the surgeon to get the needle and suture out quickly without tangling or kinking. The system is called "Direct Dispensing Packaging" or "DDP."

For better inventory control all suture is packaged 12/box.





Safil® is a violet dyed precision-braided and coated synthetic suture made from pure polyglycolic acid.



- Easy handling
- Excellent knotting ability
- Secure knot tying
- High initial tensile strength
- Smooth passage through the tissue
- Armed with a new generation of needles "Easyslide"

Safil® is degraded by hydrolysis, providing predictable and reliable absorption. Safil maintains 50 percent of its initial tensile strength after 18 days and is fully absorbed after 90 days.

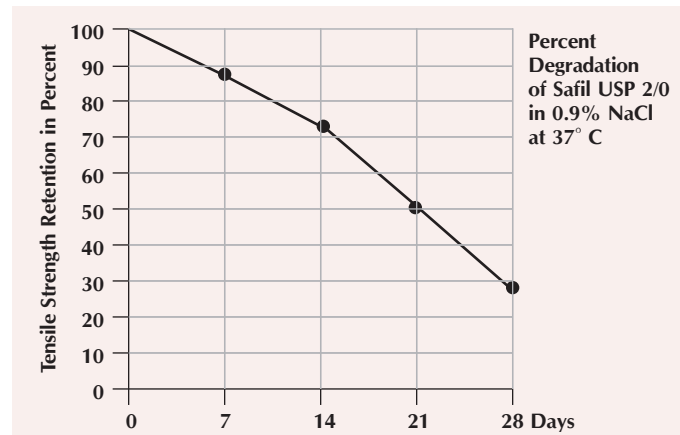

Typical Applications in Small Animal Surgery.



USP 2/0	USP 3/0	USP 4/0
	skin closure	
	subcutaneous	
muscles sutures		
intestine suture		
	hernias	
uterus		
urogenital tract		
	ligatures	
castration		

**Suture Brand Comparison:**

	Braun	Ethicon	Davis & Geck
Absorbable synthetic braided	Safil	Vicryl	Dexon
Absorbable synthetic monofilament	Monosyn	PDS	Maxon
Multi-filament nylon w/sheath	Braunamid	N/A	N/A

**Safil® Product List.**

Jorvet #	Description	Unit
JG48041	Safil HR26-3/0	12/box
JG48042	Safil HR26-2/0	12/box
JG48052	Safil HR37-0	12/box
JG48053	Safil HR37-1	12/box
JG48294	Safil HS37S-2/0	12/box
JG48221	Safil DS19-3/0	12/box
JG48235	Safil DS24-3/0	12/box
JG48236	Safil DS24-2/0	12/box

**Needle Comparison Chart.**

Jorvet	Ethicon	Davis & Geck
HR26	SH	T-5
DS24	FS-1	CE-6
DS19	FS-2	CE-4
HS37S	CP-1	C-9
HR37	CT-1	T-12
HR22	CT-2	T-19
HR17	RB-1	T-16
HR30	—	T-10
DS16	—	—
DS30	CP-2	—
HS26	—	T-5
HS26s	—	—

NOTE: Refer to page 5 for needle size.

**JorVet Safil Conversion Chart.**

Jorvet/Safil #	Safil Needle & Suture Size	Vicryl #	Vicryl Needle	Dexon II #	Dexon Needle
JG48041	HR2603/0	J0316H	SH	9233-41	T-5
JG48235	DS2403/0	H452H	FS-1	9641-41	CE-6
JG48236	DS2402/0	H453H	FS-1	9641-51	CE-6
JG48221	DS1903/0	J0398H	FS-2	9612-41	CE-4
JG48052	HR3700	J0340H	CT-1	9267-61	T-12
JG48053	HR3701	J0341H	CT-1	9267-71	T-12

NOTE: Jorgensen Labs is not responsible for any manufacturing changes or typographical errors.





**Monosyn vs. Standard Monofilament Absorbable.**

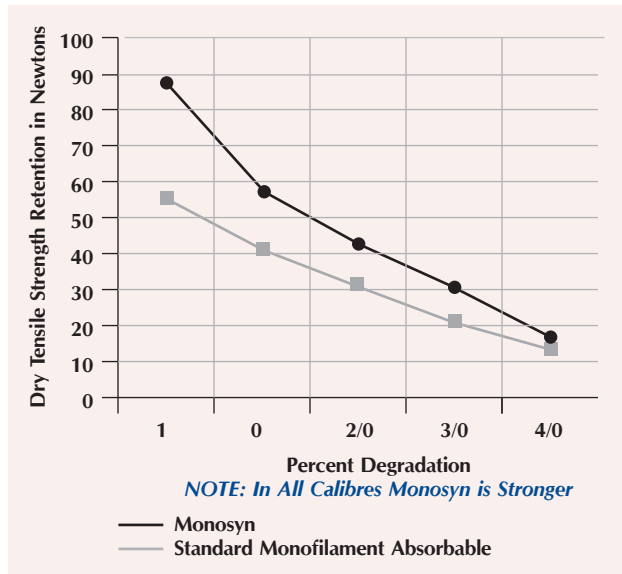

**The New Standard in Soft Tissue Surgery!**

**Monosyn.** Absorbable monofilament suture made of glyconate. Considered a midterm suture in regard to absorption as it retains 50 percent of tensile strength up to 14 days.

- Exceptional knot security and knot tensile strength.
- Smooth monofilament for ease of passage through tissue.
- Braided suture “feel”
- Absorbed via hydrolysis
- Violet color for easy identification

**Monosyn Product List.**

<b>JG22419</b>	Monosyn DS16-5/0	45cm L.	12 pk/box.
<b>JG22504</b>	Monosyn DS19-4/0	45cm L.	12 pk/box.
<b>JG22003</b>	Monosyn HR17-5/0	70cm L.	12 pk/box.
<b>JG22217</b>	Monosyn DS24-0	70cm L.	12 pk/box.
<b>JG22231</b>	Monosyn DS30-2/0	70cm L.	12 pk/box.
<b>JG22035</b>	Monosyn HR30-3/0	70cm L.	12 pk/box.
<b>JG22225</b>	Monosyn DS24-3/0	90cm L.	12 pk/box.
<b>JG22226</b>	Monosyn DS24-2/0	90cm L.	12 pk/box.
<b>JG22299</b>	Monosyn HS26-2/0	90cm L.	12 pk/box.
<b>JG22349</b>	Monosyn DS30-0	90cm L.	12 pk/box.
<b>JG22425</b>	Monosyn HR26-3/0	90cm L.	12 pk/box.
<b>JG22426</b>	Monosyn HR26-2/0	90cm L.	12 pk/box.
<b>JG22448</b>	Monosyn HR37-#1	90cm L.	12 pk/box.
<b>JG22422</b>	Monosyn HR26-4/0	90cm L.	12 pk/box.
<b>JG22904</b>	Monosyn DS19-4/0	90cm L.	12 pk/box.
<b>JG22905</b>	Monosyn DS19-3/0	90cm L.	12 pk/box.

**Needles.** Jorgensen Laboratories offers a full selection of needles for all veterinary needs. Sizes available include 2, 4, 6, 8, 10, 11, 12, 13, 14, 16, 18 and 20 in  $\frac{3}{8}$ -circle and  $\frac{1}{2}$ -circle models. 12/pk.

*NOTE: These represent actual size of needle.*

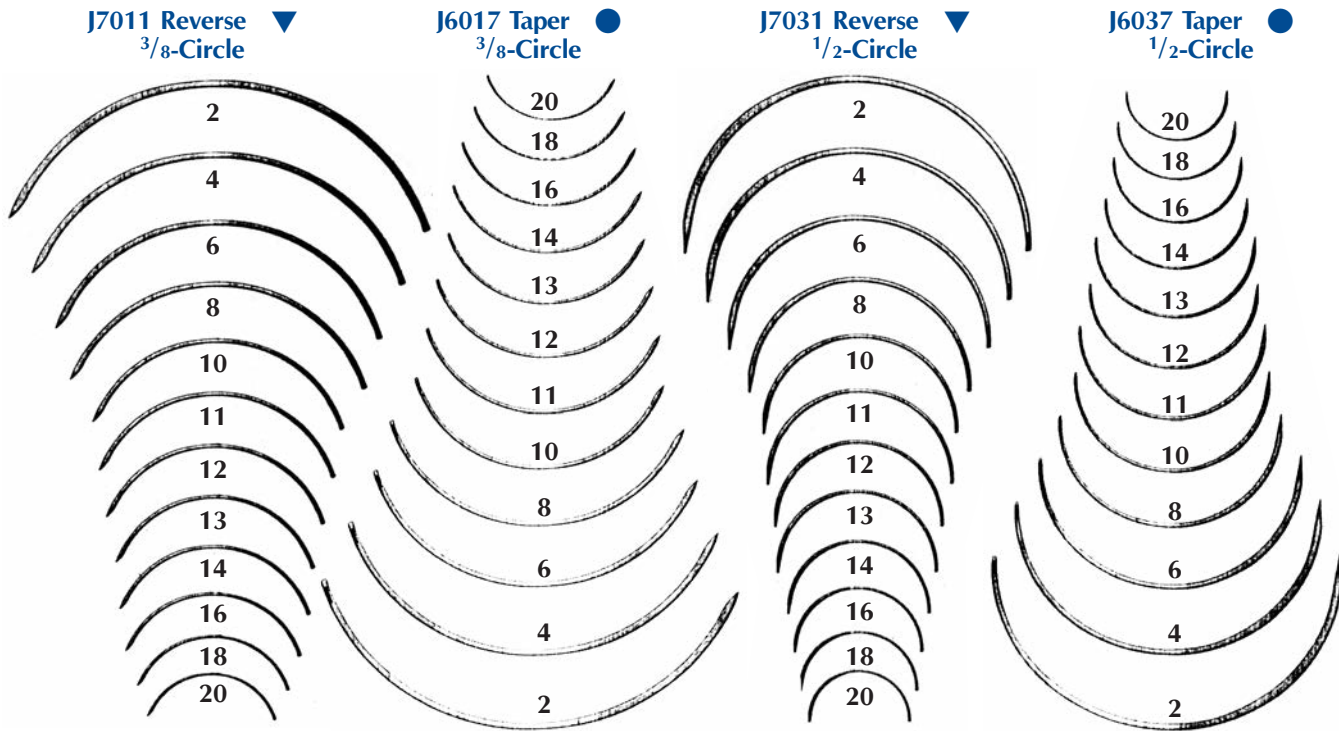

**Reverse Cutting Needle. ▼**

Reverse Cutting Needles are available in stainless steel with regular eye in both  $\frac{3}{8}$ -circle or  $\frac{1}{2}$ -circle models.

**J7031xL Reverse Cutting Needle.**  $\frac{3}{8}$ -circle.  $3\frac{1}{4}$ ". Extra heavy needles for bovine and equine use. 12/pk.

**Taper Needle. ●**

Taper Needles are available in the same sizes in  $\frac{3}{8}$ -circle or  $\frac{1}{2}$ -circle.

**J6037xL Taper Needle.**  $\frac{3}{8}$ -circle.  $3\frac{1}{4}$ ". Extra heavy needles for bovine and equine use. 12/pk.

*NOTE: When ordering, please specify number and size for needles desired.*

**J0177 Loopuyt's Needle.** Cutting edge needle. 12/pk.

- J-177a Loopuyt's Needle #1.**
- J-177b Loopuyt's Needle #3.**
- J-177c Loopuyt's Needle #5.**

**J0105r Suture Needle Rack.** Convenient spring action model for holding suture needles.

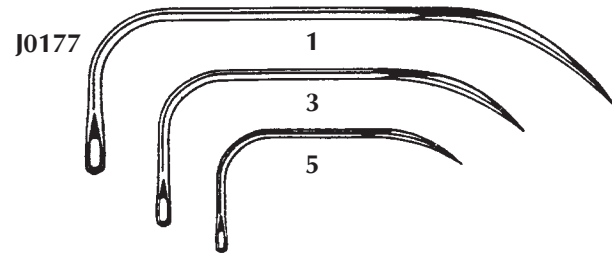
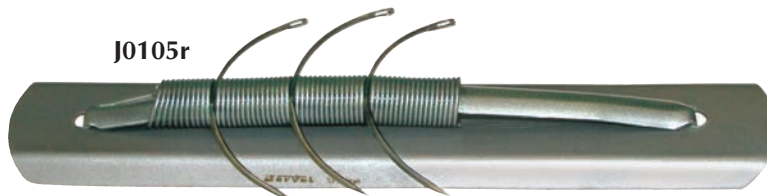

**J7050a** 1 $\frac{1}{2}$ "

**J7050b** 2"

**J7050c** 2 $\frac{7}{8}$ "

**J7050d** 4"

**J7050e** 6"

**J7050 Keith Straight Bodied Needle.**

Triangular cutting point. 6/pk.





**Large, Extra Heavy-Duty Needle.**  $\frac{3}{8}$ -curved. Stainless steel. Cutting edge. Length refers to actual length of needle. 12/pk.

- J0110pm3 Needle.** 3".
- J0110pm4 Needle.** 4".
- J0110pm5 Needle.** 5".
- J0110pm6 Needle.** 6".

*NOTE: Please refer to page 34 for large DA needles.*

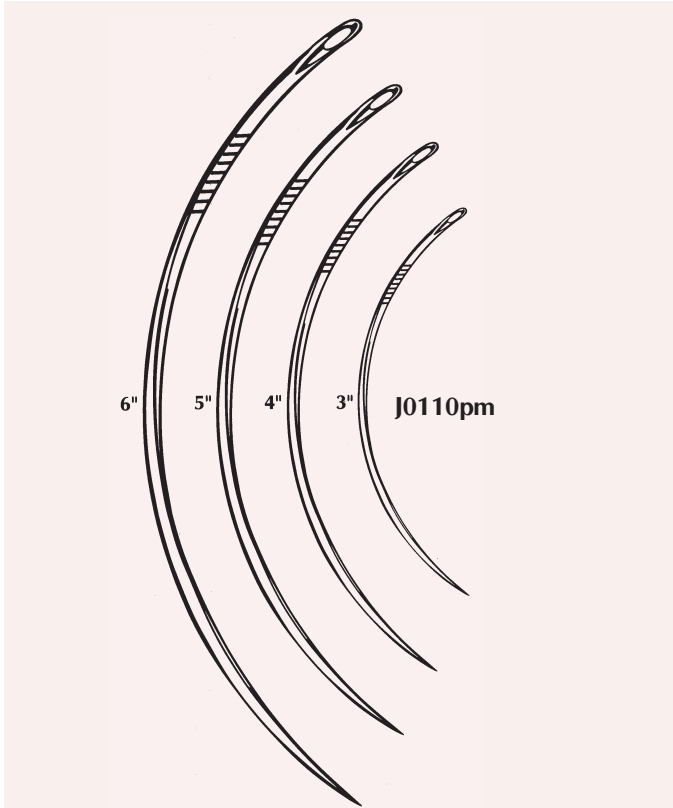

**Large, Extra Heavy-Duty Half Curved Needle.** Stainless steel. Cutting edge. 12/pk.

- J0110hc3 Needle.** 3".
- J0110hc4 Needle.** 4".
- J0110hc5 Needle.** 5".
- J0110hc6 Needle.** 6".

**J0110t Half Curved Triangular Needle.** Cutting edge. 12/pk.

*NOTE: When ordering put size after J-110t to indicate desired size.*

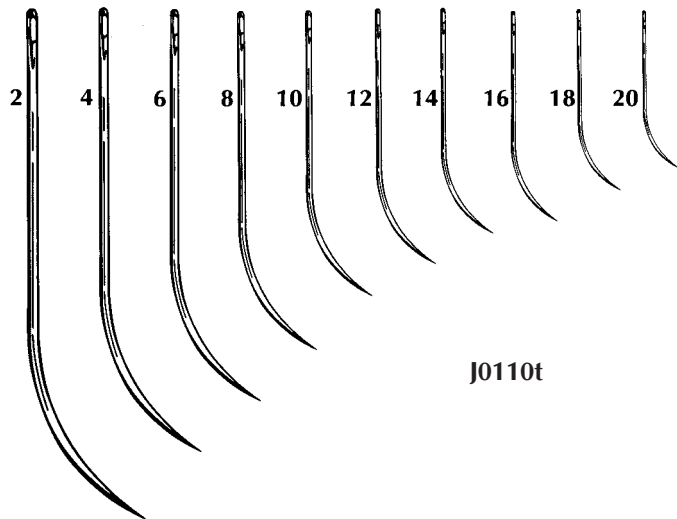
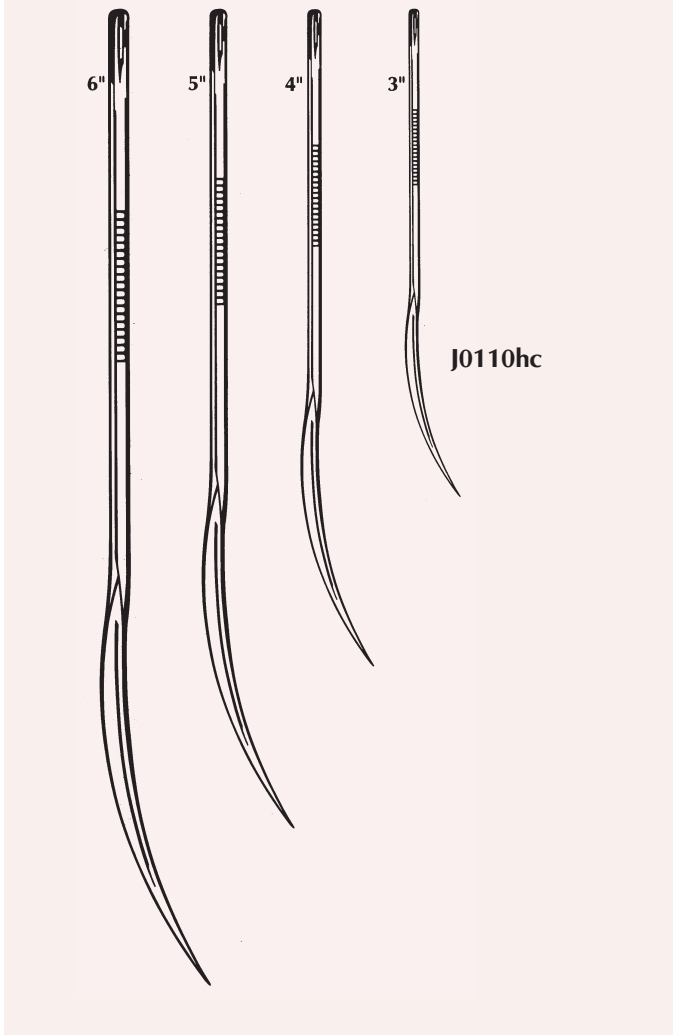

**Surgi-Close™ Skin Staplers.** Wound closure with the most economical external stapler just became easier. Over 80 percent of all human surgical wound closures involve the use of skin staplers. In veterinary surgery, less than 10 percent of surgeries utilize skin staplers.

Why is there such a wide difference in usage?

The use of skin staplers has been limited in veterinary surgery due to the high cost of disposable human skin staplers. The use of sutures with needle packs has been less expensive to close the skin (average cost ranges \$4-\$5). The introduction of the Surgi-Close stapling system addresses the specific needs of the veterinary surgeon.

Benefits:

- Better apposition of skin edges with better cosmetic results.
- Less reactivity of stainless steel staples
- Significantly faster wound closure
- Ease of learning proper technique.

Features:

- 20-pack staple cartridges cost less than a pack of needle suture, and is a huge savings over conventional throw away skin staplers
- Both handle and staples are provided sterile
- Staple cartridges are inserted into the handle and are specially designed to reduce jamming
- Handle can be autoclaved for repeated use
- 20-staple cartridge sufficiently closes a 4"–5" incision
- Closed staple shaped squarely, restricting movement or rolling of a staple

**J0800** **Staples** are now lubricated with USP Sodium Stearate to promote easier forming taking less force and quicker release without the necessity to lubricate the handle between uses. This takes the hassle out of using cost effective stapling for wound closure. Staples are packaged in a sterile pouch from a dispensing box. 20/pk cartridge. 36 cartridges/box.

**J0800x** **Surgiclose Staples.** 24 pack of 20 staple cartridges. New packaging in dispensing box. Each cartridge is in its own separate chevron shaped pouch.

**J0799** **Staple Handle** requires cleaning and sterilizing between uses, but there is no longer the need to lubricate the former between uses. Each staple is lubricated with a coating of USP Sodium Stearate for easy penetration, reducing forming force and release from the former. Staple handle packaged in sterile pouch from a dispensing box.

**J0799r** **Staple Removal Forceps** will work with any brand of skin staple.

**J0800s** **Starter Kit.** Includes:

- 6 cartridges of 20 staples
- 1 stapler handle
- Staple removal forceps

**Manipler® AZ.** Braun/Aesculap. Newest development in surgical skin staplers.

**J0800m** **Manipler® AZ.**  
 Type – wide  
 35 staples per staple handle  
 Crown – 6.9mm  
 Leg 3.6mm  
 6 staplers per box  
 Sterile

This is lightweight with a modern ergonomic design. This model is very popular in Europe.



J0799

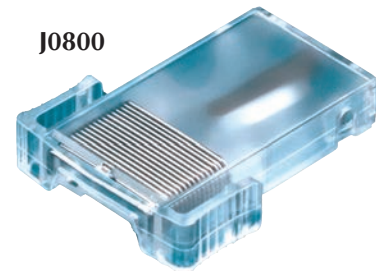

J0800

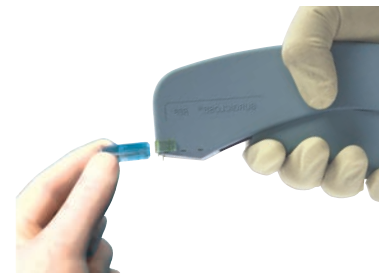

J0799r



J0800m





**Henke Roux Revolver** is a high quality precision-made revolver syringe. Of German origin it's known for its accuracy. Dosage is set by turning the dosage setting wheel at the rear of the barrel. For long lasting dependability, durability and accuracy, buy the "HENKE" Roux.

- J0053h** Henke Roux. 50cc, adjusts 1, 2, 3, 4 & 5cc.
- J0053ha** Henke Roux. 30cc, adjusts 1, 2, 3, 4 & 5cc.
- J0053hb** Henke Roux. 10cc, adjusts to 1/4, 1/2 & 1cc.
- J0053d26q Plastic Barrel**, 30cc with LL.
- J0053d26r Plastic Barrel**, 50cc with LL.

*NOTE: When ordering parts, place letter **B** behind any 10cc part, and letter **A** behind any 30cc part.*



**J0053f91 Ferromatic Automatic Syringe.** Uniquely design has dosage adjustments from .5ml to 5.0ml. Fits bottle tops from 30ml–120ml. Features:

- One-piece front end with luer lock
- A valve accessory allows user to adapt the syringe for use with a collapsible bottle (**part #14c** optional)
- Tubing and attachment to allow draw offs from bottles (optional)
- New plastic valve system to prevent valve "swelling"

**J0053fd91 Parts:**

- J0053fd191 Barrel frame
- J0053fd2m Glass barrel\*
- J0053fd391 Piston
- J0053fd4 O-Ring\*
- J0053fd591 Piston rod & handle
- J0053fd691 Front screw
- J0053fd791 Guiding cap
- J0053fd891 Dosing device
- J0053fd991 Fixing nut
- J0053fd10m End washer\*
- J0053fd1191 Compression spring
- J0053fd12 Rubber valve\*
- J0053fd1291 Plastic valve & washer
- J0053fd1391 Valve spring
- J0053fd14c Valve head for collapsible bottle m91

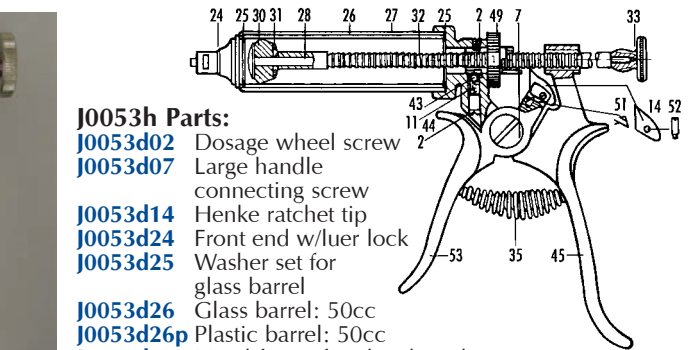

**J0053h Parts:**

- J0053d02** Dosage wheel screw
- J0053d07** Large handle connecting screw
- J0053d14** Henke ratchet tip
- J0053d24** Front end w/luer lock
- J0053d25** Washer set for glass barrel
- J0053d26** Glass barrel: 50cc
- J0053d26p** Plastic barrel: 50cc
- J0053d27** Metal frame for glass barrel: 50cc
- J0053d28** Inner rod: 50cc
- J0053d30** Rubber piston
- J0053d31** Piston holding disc
- J0053d32** Outer rod with ratchet teeth: 50cc
- J0053d33** Knurled knob
- J0053d35** Coil spring for handles
- J0053d42** Henke set screw
- J0053d43** Henke steel ball, 4mm
- J0053d44** Compression spring
- J0053d45** Henke rear handle
- J0053d49** Henke dosage wheel
- J0053d51** Henke ratchet clip
- J0053d52** Henke ratchet screw
- J0053d55** Henke forward handle

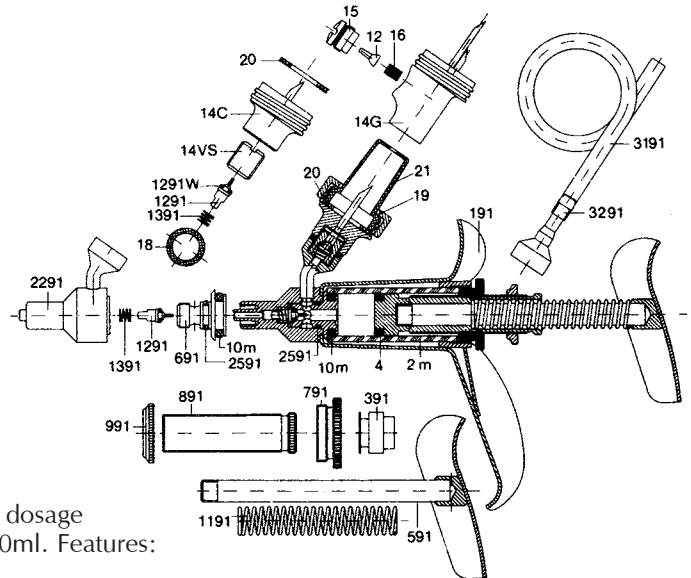

- J0053fd14G Valve head for rigid bottle m91
- J0053fd14VS Valve screw
- J0053fd15 Valve head screw\*
- J0053fd16 Outlet valve spring\*
- J0053fd18 Washer for 14c
- J0053fd19 Screw cap\*
- J0053fd20 Washer for 14g\*
- J0053fd21 Closing cap\*
- J0053fd2291 Front end and luer lock
- J0053fd3191 Tubing
- J0053fd3291 Tubing attachment
- J0053fd2591 Washer
- J0053fd2891 Repair kit (4, 10m, 1191, 2 of 1291, 1391, 1691, 18, 20, 2591)

\*Interchanged with 1986 model

*NOTE: The following parts are shown on the parts diagram, but are not sold individually. They must be purchased as part of a kit: **J0053fd2891** (4, 10m, 1191, 2 of 1291, 1391, 1691, 18, 20, 2591).*



**Hauptner Syringe.** Famously accurate and correct dosing.

- J0031a** 10cc, adjusts to 1/4, 1/2, 3/4, and 1cc doses.
- J0031b** 30cc, adjusts to 1, 2, 3, 4, and 5cc doses.
- J0031c** 50cc, adjusts to 1, 2, 3, 4, and 5cc doses.
- J0031e** 25cc, adjusts to 1/2, 1, 1 1/2, 2 and 2 1/2.  
Excellent for injecting Ivomec®.

*NOTE: When ordering these parts place letter **A** behind any 10cc part, **B** behind any 30cc part, **C** behind any 50cc part, or **E** behind any 25cc part needed. Letter not needed for parts that interchange for all sizes.*



**Vetamatic Syringe.** A handy, sturdy automatic multidose syringe. Plastic valve and washer reduces swelling problems. .5ml to 5.0ml.

**J0053v94 Vetamatic Syringe.**

*NOTE: Spare Parts Ordering: Parts 13, 1494 and 1694 as shown on parts diagram are not available individually. They can be purchased only as a repair kit: **J0053vd 2894***

**Hauptner Syringe Parts:**

- J0031d01** Complete grip
  - J0031d01d** Adaptor (not pictured) needed for 10cc or 25cc only
  - J0031d02** Grip part less dosage sleeve
  - J0031d02r** Grip part with dosage sleeve
  - J0031d03** Grip part with ratchet \*\*
  - J0031d04** Locking screw \*\*
  - J0031d05** Spring for grips \*\*
  - J0031d06** Ratchet with screw \*\*
  - J0031d07** Small ratchet spring \*\*
  - J0031d08** Dosage sleeve, separate
  - J0031d09** Complete plunger rod: 10, 30, 50, or 25cc
  - J0031d10** Inner plunger rod: 10, 30, 50, or 25cc
  - J0031d11** Outer plunger rod: 10, 30, 50, or 25cc
  - J0031d12** Small plate for plunger
  - J0031d13** Tension screw \*\*
  - J0031d14** Metal cover for glass barrel: 10, 30, 50, or 25cc
  - J0031d15** Glass barrel: 10, 30, 50, or 25cc
  - J0031d15p** Plastic barrel: 30 or 50cc
  - J0031d16** Washers/pk. set (includes nos. 16mm, 17mm, 18mm)
  - J0031d22** End plate with Luer lock
- \*\* Interchangeable with 50, 30, and 25cc Hauptner syringes

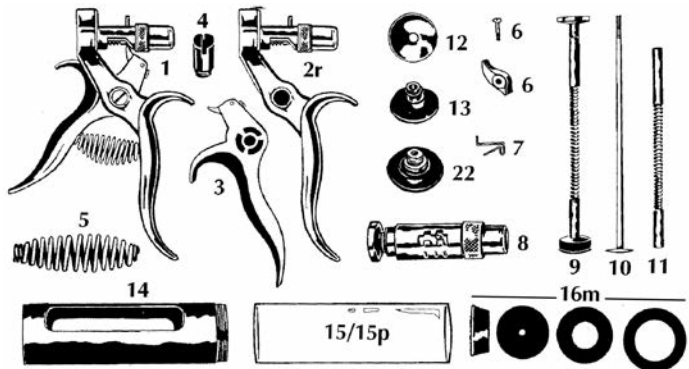

**Vetamatic Syringe J0053v94 Parts:**

- J0053vd 1m** Metal frame
- J0053vd 294** Front screw
- J0053vd 4m** Glass barrel
- J0053vd 594** Piston rod & handle
- J0053vd 794** Spring sleeve
- J0053vd 894** Dosing sheath
- J0053vd 994** Fixing nut
- J0053vd 1094** Screw cap
- J0053vd 1294** Piston
- J0053vd 13** Washer
- J0053vd 1494** Valve & washer
- J0053vd 1694** Valve spring
- J0053vd 1794** Front end
- J0053vd 23** Tubing
- J0053vd 24a** Filler needle, 4 3/4"
- J0053vd 24b** Filler needle, 7 1/2"
- J0053vd 24c** Filler needle, 8 1/2"
- J0053vd 2894** Repair kit (2 x 13, 1494 x 2, 1694)



**J0053vd 4m**

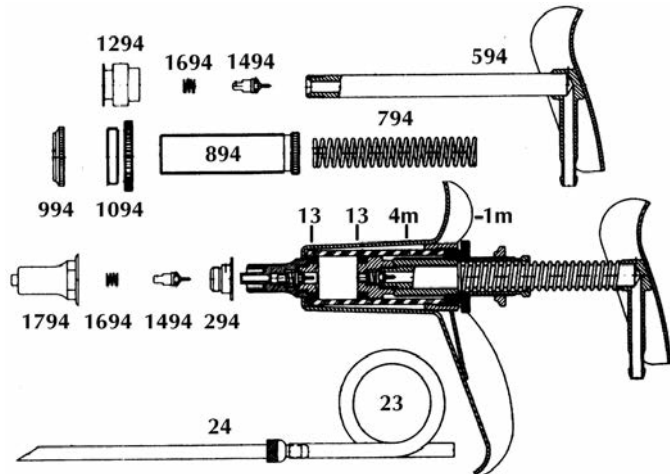

**JorVet Nylon Syringe.** The nylon syringe, with an expanded range of sizes, is now available. Virtually unbreakable nylon with transparent barrel, economically priced with easy-to-read black etched dose markings. Combination of luer lock and luer slip adaptor.



J0111 Series

<b>J0111an</b>	10cc.	<b>J0111ano</b>	10cc, "O" ring.	Includes dosage wheel.	
<b>J0111bn</b>	20cc.	<b>J0111bno</b>	20cc, "O" ring.	<b>J0111awn</b>	10cc.
<b>J0111cn</b>	30cc.	<b>J0111cno</b>	30cc, "O" ring.	<b>J0111bwn</b>	20cc.
<b>J0111dn</b>	50cc.	<b>J0111dno</b>	50cc, "O" ring.	<b>J0111cwn</b>	30cc.
<b>J0111fn</b>	100cc.	<b>J0111fno</b>	100cc, "O" ring.	<b>J0111dwn</b>	50cc.

**J0111jw Dose Syringe – 400cc** capacity: over 13 ounces. Manufactured with an almost unbreakable, clear nylon barrel—excellent for use with stomach tubes or for rinsing out the mouth before a dental procedure. Includes silicone lubricant. Nozzle: 4"L. 1/4" i.d. dia.

**J0111jwo "O" Ring** for J0111jw syringe.  
**J0111jwd#1 Nozzle** only.

**J0111jwL Dose syringe**, 600 ml.

**J0111q Sheep/Goat Oral Drench Kit.** A handy kit that has everything needed for drenching small ruminants. Includes an extra "O" ring to fit a 20cc nylon syringe, and an oral dose adaptor.

**J0111s Silicone Lubricant.** 30ml. (not pictured)

**Large Drencher.** These drenchers allow for administration of large doses often necessary to treat adult cattle. The use of oral calcium or propylene glycol drenches are easier with large drencher.

- Curved nozzle with olive tip
- Clear barrel to see medication
- High impact plastic handle

**J0640 300cc Capacity Drencher.**

**J0640d1 "O" Ring** for 300ml.

**J0640d2 Barrel** only 300ml.

**J0641 200cc Capacity Drencher.**

**J0641d1 "O" Ring** for 200ml.

**J0641d2 Barrel** only 200ml.

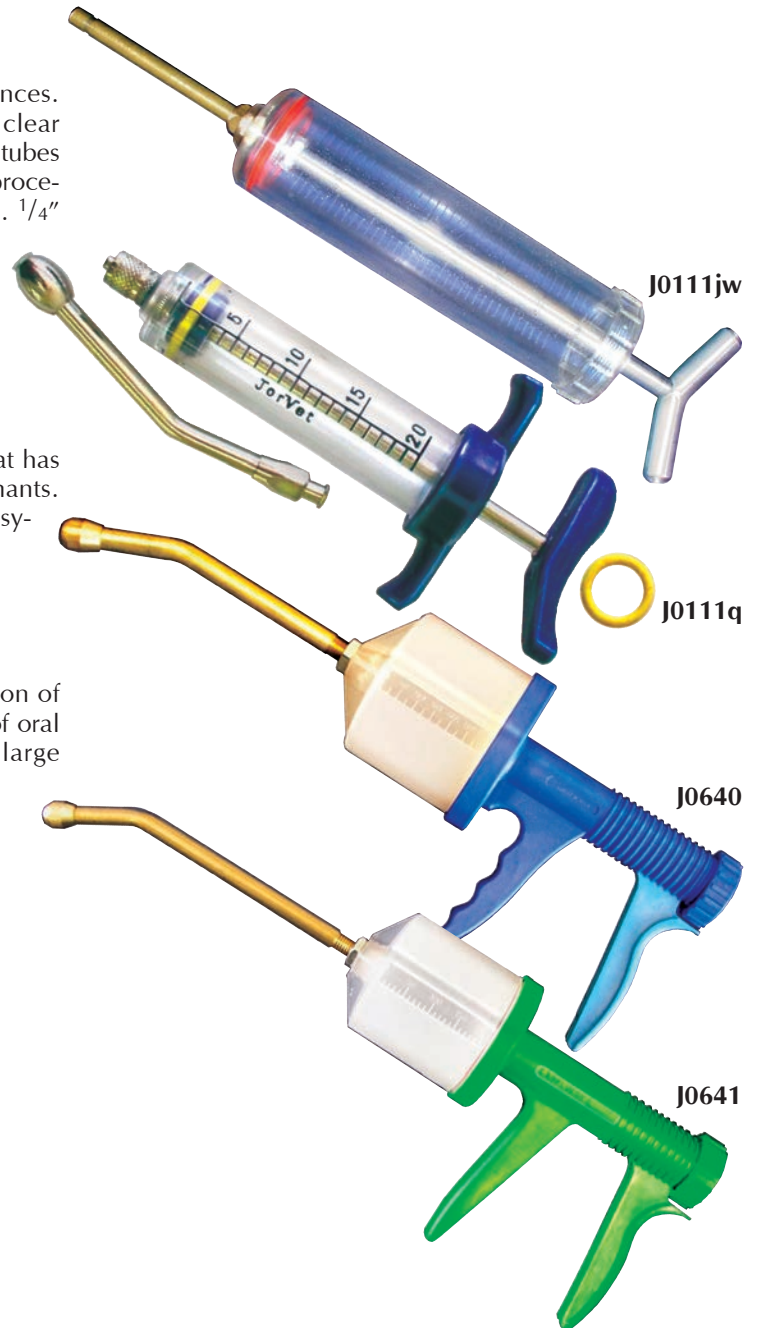



**Vaxi-Drench 15 Injector/Drencher.** Designed for administration of all drenches or injectable solutions within its dose range. Comes complete with 2.9 liter vinyl reservoir, strapping and necessary tubing. Manufactured exclusively for Jorgensen Labs. Adjust from 2.5cc to 15cc in 1/2cc increments.

**J0126 Injector/Drencher.**

**J0126d Parts.**

- |                             |                                  |
|-----------------------------|----------------------------------|
| 1. Piston cap               | 18. Cylinder                     |
| 2. Valve spring             | 19. Adaptor                      |
| 3. Valve and seal ring      | 20. Lever                        |
| 4. Piston washer (set of 2) | 21. Lever pad (set of 2)         |
| 5. Piston spacing washer    | 22. Handle                       |
| 6. Push rod                 | 23. Dose adjuster screw and nut  |
| 7. Valve and seal ring      | 24. Return spring                |
| 8. Valve spring             | 25. Return spring adjuster       |
| 9. Nozzle seal ring         | 26. Return spring adjuster screw |
| 10. Injection attachment    | 27. Lever screw                  |
| 11. Needle nut              | 28. Handle clamp screw           |
| 12. Nozzle                  | 29. Container complete           |
| 13. Delivery cage lock nut  | 30. Feed tubes & clamps          |
| 14. Delivery cage           | 31. Cap & nozzle                 |
| 15. Cylinder cage           | 32. Repair kit –                 |
| 16. Nozzle nut              | Parts 2, 3, 4, 7, 8, 9, &        |
| 17. Cylinder seal ring      |                                  |

17

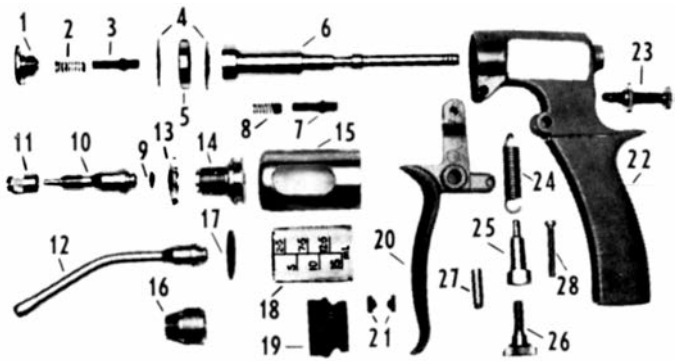

*NOTE: Please order by part number and name.*

The **Henke Drench-Matic 23cc** is an automatic syringe for administration of solutions and suspensions. Its transparent plastic graduated barrel allows instant check of dosage setting. An “anti-block” valve system prevents blocking, so that smooth continuous operation is guaranteed. Easily adjusts from 0–23ml in 2.5ml increments. Special hardened enamel painting provides both aesthetics and durability.

**J0128m Drench-Matic Syringe** complete with container.

**J0128md Parts.**

- |   |  |
|---|--|
| 1. Barrel frame                                   | *18. Plastic insert (2)  |
| 2p. Plastic barrel 23cc                           | *19. Handle screw  |
| 3. Front end piece                                | *20. Dosing screw  |
| *4. Round washer                                  | *21. Dosing screw nut  |
| 5. Lock nut for #3                                | 22. Handle spring  |
| 6. Valve & washer                                 | *23. Lower spring screw  |
| *6w. Valve washer only                            | *24. Disc  |
| 7. Valve spring                                   | *25. Knurled knob  |
| 8. Nozzle & washer                                | *26. Frame Screw   |
| 8w. Nozzle washer only                            | *28. Feeding tube (not pictured)                               |
| 9. Nozzle nut                                     | 30. Injection attachment                                       |
| 10. Piston rod complete (6, 7, 11, 12, 13(2), 14) | 30w. Washer for #30  |
| 11. Piston rod                                    | 31. Container complete   |
| 12. Valve screw                                   | 32. Cap & nozzle   |
| 13. Piston washer                                 | 33. Straps   |
| 14. Nylon piston                                  | 36. Repair kit (4(1), 6(2), 7(2), 8w(1), 13(1), 14(1), 30w(1)) |
| *15. Front handle                                 | * Interchangeable with our J-128 Henke Drench-Matic 20cc.      |
| *16. Spring pin                                   |  |
| *17. Rear handle                                  |  |

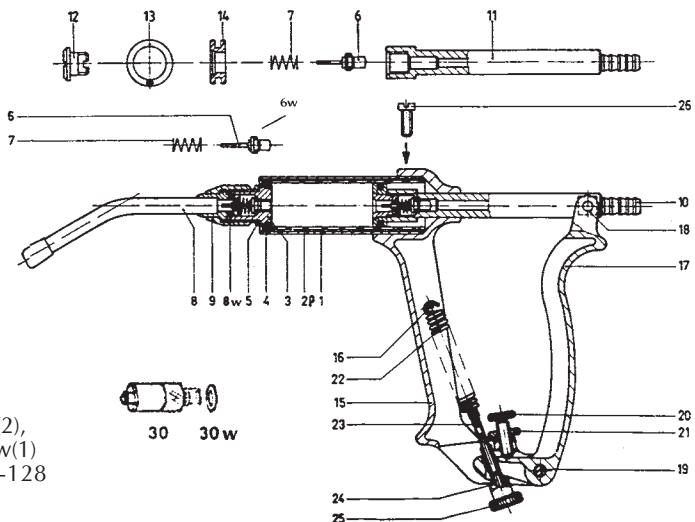



**JorVet Premium Needles.** German quality. Extra sharp reusable stainless steel. Round hub. Packaged in attractive clear plastic case. 10/pkg.

14g		16g		18g	
J0870da	1/2"	J0870cb	3/4"	J0870bb	3/4"
J0870db	3/4"	J0870cc	1"		
J0870dc	1"				
		J0870cg	3"		
J0870dh	4"	J0870ch	4"		

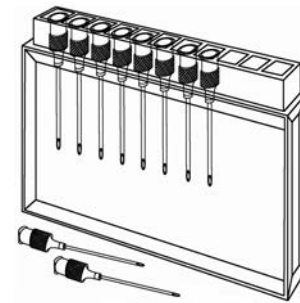

**Hypodermic Needles.** Stainless steel. Round hub. Packaged in cardboard box or plastic clear case. 12/pkg.

12g		14g		16g		18g		20g	
	—	J0174da	1/2"	J0174ca	1/2"	J0174ba	1/2"	J0174aa	1/2"
		J0174db	3/4"	J0174cb	3/4"	J0174bb	3/4"	J0174ab	3/4"
J0174ec	1"	J0174dc	1"	J0174cc	1"	J0174bc	1"	J0174ac	1"
		J0174dx	1 1/4"						
J0174ed	1 1/2"	J0174dd	1 1/2"	J0174cd	1 1/2"	J0174bd	1 1/2"	J0174ad	1 1/2"
J0174ee	2"	J0174de	2"	J0174ce	2"	J0174be	2"	J0174ae	2"
J0174ef	2 1/2"			J0174ci	3 1/2"	J0174bg	3"		
J0174eg	3"	J0174dg	3"	J0174cg	3"	J0174bh	4"		
				J0174ch	4"				
J0174eh	4"	J0174dh	4"	J0174cj	6"	J0174bj	6"		



**Economy Hypodermic Needles.** Less expensive range of needles. Square hub with standard luer fit. Each needle imprinted with gauge size. 12/pkg.

**J0180:**

	1/2"	(a)		1/2"	(a)		1/2"	(a)
	3/4"	(b)		3/4"	(b)		3/4"	(b)
<b>d</b>	1"	(c)	<b>c</b>	1"	(c)	<b>b</b>	1"	(c)
<b>14g x</b>	1 1/2"	(d)	<b>16g x</b>	1 1/2"	(d)	<b>18g x</b>	1 1/2"	(d)
	2"	(e)		2"	(e)		2"	(e)
	3"	(g)		3"	(g)			
	4"	(h)		4"	(h)			

*NOTE: When ordering sizes, place gauge letter behind J-180; then 2nd letter indicating shaft length (i.e., J0180dc for 14g x 1" needle).*

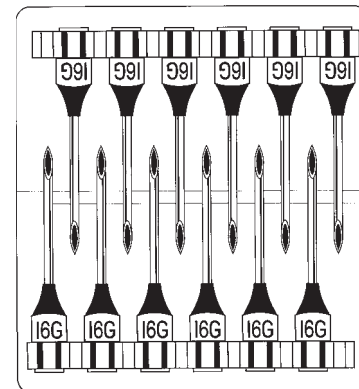

**Thunderbolt Aluminum Hub Hypodermic Needles** have aluminum hubs with stainless steel needle cannulas and are especially designed for the demands of injecting large animals. The needles are razor sharp and individually packaged in their own disposable two-piece cartridges. Sterile. 100/pkg.

Features:

- Color coded by gauge
- Marked with needle gauge and length
- Competitively priced

<b>J0956</b>	<b>Needle.</b> 14g x 3/4".	<b>J0963</b>	<b>Needle.</b> 16g x 2".
<b>J0957</b>	<b>Needle.</b> 14g x 1".	<b>J0965</b>	<b>Needle.</b> 18g x 3/4".
<b>J0958</b>	<b>Needle.</b> 14g x 1 1/2".	<b>J0965a</b>	<b>Needle.</b> 18g x 5/8".
<b>J0959</b>	<b>Needle.</b> 14g x 2".	<b>J0966</b>	<b>Needle.</b> 18g x 1".
<b>J0964</b>	<b>Needle.</b> 16g x 5/8".	<b>J0967</b>	<b>Needle.</b> 18g x 1 1/2".
<b>J0960</b>	<b>Needle.</b> 16g x 3/4".	<b>J0968</b>	<b>Needle.</b> 18g x 2".
<b>J0961</b>	<b>Needle.</b> 16g x 1".	<b>J0971</b>	<b>Needle.</b> 20g x 1/2".
<b>J0962</b>	<b>Needle.</b> 16g x 1 1/2".	<b>J0972</b>	<b>Needle.</b> 20g x 1".



**J0173t** **Popular Style Transfer Needle** has a concave metal plate where the finger can steady the transfer needle during mixing. Stainless steel. 14g x 3". Packaged in plastic vial.

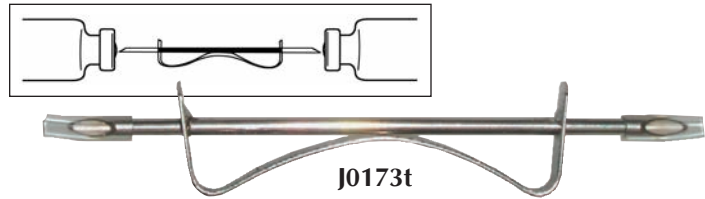

**J0173s** **Transfer Needle.** Double ended transfer needle. One end is a 1/2" 17g needle and the other end is a 1" x 19g needle. Sterile. The best choice for rehydrating solutions. 12/pkg.

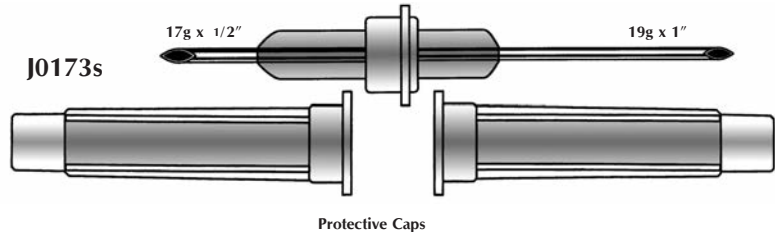

**J0173** **Transfer Needle.** Double pointed. Stainless steel. 16g x 1 1/4". 12/pkg.

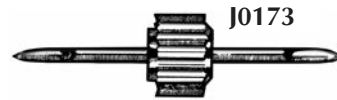

**J0464m** **Male/Female Protective Cap.** This unique two piece cap can be used to protect or cover the open ends of either a male luerlock or a female luerlock. Sterile. 100/box.  
Possible uses:  
• Syringe cap  
• IV catheter  
• IV set

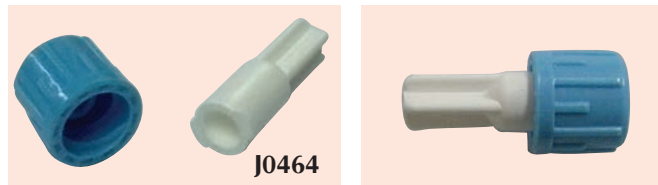

**J0206** **Dose Adaptor.** Fits all standard luer lock and luer tip syringes. 4".



**Blunt tip needles.** These blunt end needles have a wide range of applications around the clinic including:

- anal sac irrigation
- wound flushing
- lacrimal duct flush
- male cat urethral flush
- feeding needle

These blunt ends have a polished straight stainless cannula with a polypropylene color-coded hub. Non-sterile 5 pack.

**J1032** 14 g X 1 1/2" white hub

**J1032a** 14g X 1"

**J1032b** 16g X 1 1/2" charcoal gray

**J1032c** 16g X 1"

**J1032d** 18g X 1 1/2" green

**J1032e** 18g X 1"

**J1032f** 22g X 1 1/2" blue

**J1032g** 22g X 1"

**J1032h** 22g X 1/2"

**J1032j** 25g X 1 1/2" red

**J1032k** 25g X 1"

**J1032m** 25g X 1/2"

**J1032n** 30g X 1/2"

**J1032x** Sample pack gives 2 needles of all sizes and lengths 26 needles total. Not autoclavable.



**J1032 and J1033 series**

Blunt tip needles. Straight but flexible. Have a polypropylene burr free shaft with poly hub 5 pack non-sterile.

**J1033** 15g X 1 1/2"

**J1033a** 15g X 1/2"

**J1033b** 18g X 1 1/2"

**J1033c** 18g X 1/2"

**J1033d** 20g X 1 1/2"

**J1033e** 20g X 1/2"

**J1033f** 25g X 1 1/2"

**J1033g** 25g X 1/2"

*NOTE: Pre-bent needles are not available.*

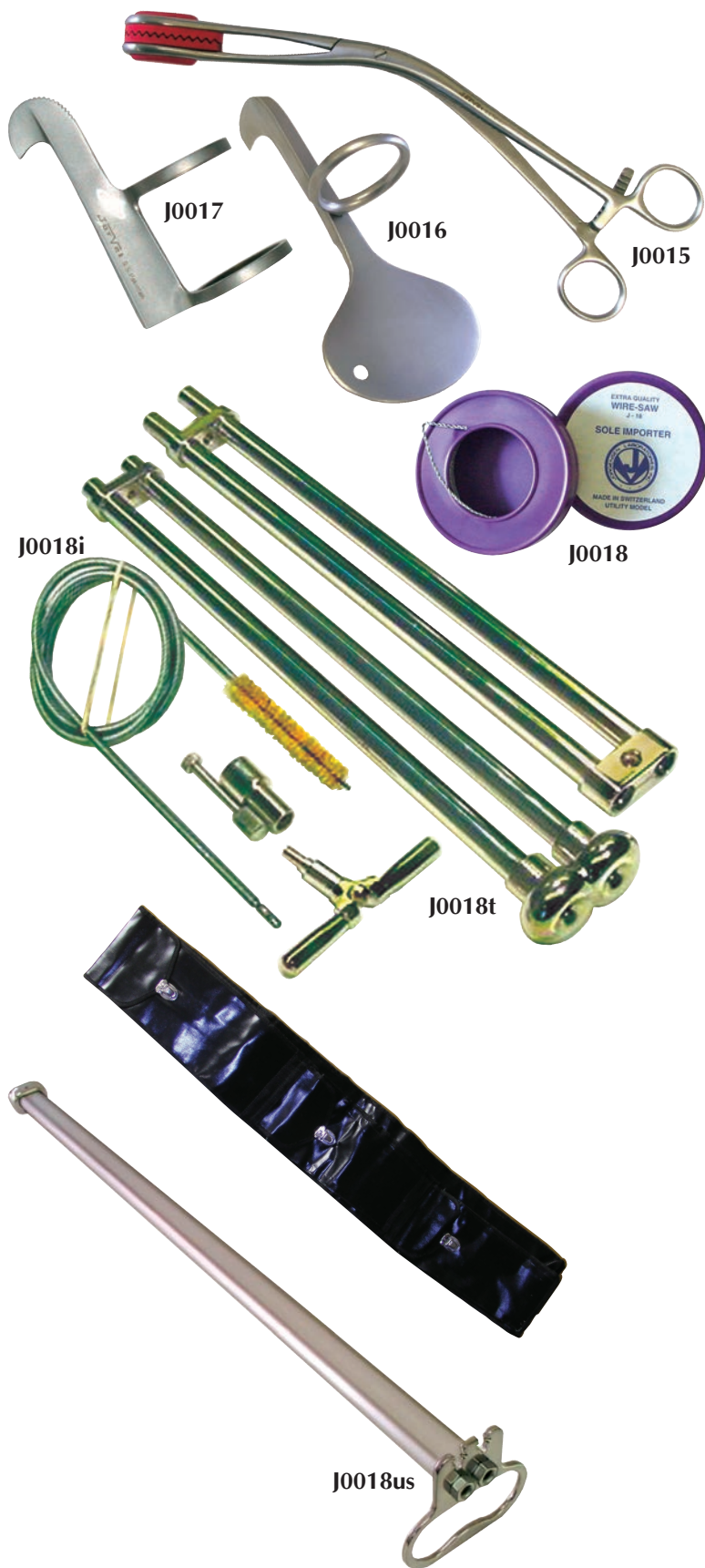

**J0015** **OB Caesarean Forceps.** With removable soft rubber jaws for grasping the uterus. Stainless steel. 12"L.

**J0015c** **Bovine Cervical Forceps.** (not pictured)

**J0015ce** **Equivet Cervical Forceps.** To grasp equine cervix during embryo transfer. 54 cm L 30mm jaw. (not pictured)

**J0016** **Linde's Embryotomy Knife** with one large finger ring and handle adapted to the palm. Stainless steel. 5"L.

**J0017** **Guenther's Embryotomy Knife** with two finger rings. Stainless steel. 2<sup>1</sup>/<sub>2</sub>"L.

**J0018** **OB Saw Wire.** The finest available; rapid cutting, rust resistant; 27 braided filaments. Unused wire can easily be returned into this handy plastic dispenser pack. 10 meters L.

**J0018h** **Hauptner OB Wire.** 10 meters.

**J0018t** **Thygesen's Fetatome.** Two-tube model with adjustable handle for OB chain. This is the breakdown model, complete with insertion coil and cleaning brush. 33"L.

**J0018i** **Insertion Coil and Cleaning Brush** for fetatomes.

**J0018c** **Fetatome Case.** This vinyl case is a great organizer with individual pockets for OB handles, wire saw, chains and other OB equipment. Also protects fetatome from scratches and wear.

**J0018us** Lightweight model **Utrecht Fetatome**, with hardened metal head. Includes modified grip with notched plate for OB chains. Complete with insertion coil and cleaning brush. 38"L.



J0019



J0019c



J0019r

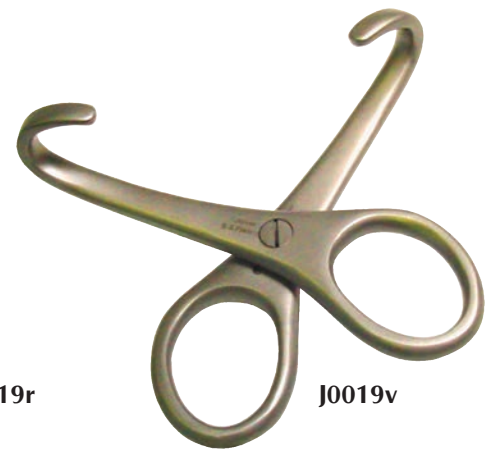

J0019v

**J0019 Krey Hook.** This double-action OB hook will bite into part of the fetus in the process of doing an embryotomy. Should the instrument slip, the hooks will close automatically and prevent injury. Stainless steel. 8"L.

**J0019c Ostertag's Blunt Eye Hook.** Stainless steel. Hole  $\frac{5}{8}$ " dia. Hook  $\frac{3}{4}$ "L. Total 2"L.

**J0019h Harms OB Hook.** Stainless steel. Similar to J-19c only longer. 4"L. (not pictured)

**J0019hs OB Hook.** Sharp.

**J0019hb OB Hook.** Blunt End.

**J0019r Ruggeberg's Spring-Type OB Double-Eye Hook.** Very easy to use.  $5\frac{1}{2}$ "L.

**J0019v Vienna Double Blunt Eye Hook.** Stainless steel. Hinged for easier placement.  $5\frac{1}{2}$ "L.

**J0020 OB Wire Guide.** This instrument will bring your wire around any tight or difficult location on the fetus. 7"L.

**J0020h Hauptner OB Wire Guide.** Wire is pushed into the end of the guide and fastened. The weighted ball end drops easily over the animal. 7"L.

**J0020d OB Wire Drop Guide.** This is an excellent guide, as it is heavy enough and shaped to permit easier passage around the fetal part. Stainless steel.  $3\frac{1}{2}$ "L.

**J0021 Swedish OB Wire Handle and Wire Container.** Serves both as a handle and also as a handy dispenser.

**J0021h OB Wire Handle** locks on your OB wire and holds even during a very hard pull.  $3\frac{1}{2}$ "L.



J0020

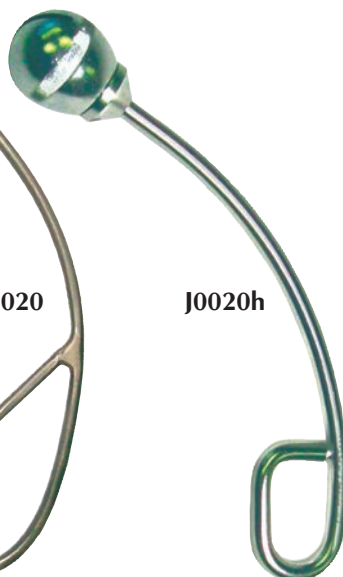

J0020h



J0021h



J0020d



J0021



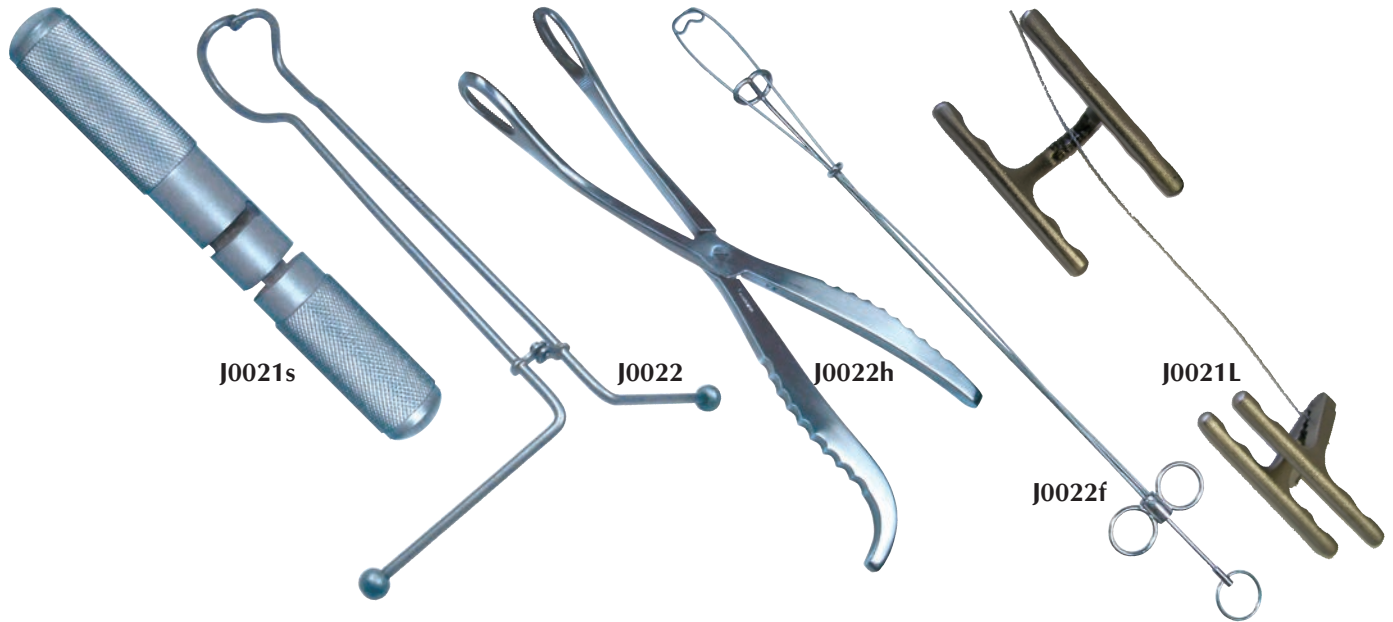

**J0021s** **Sutter Style OB Handle.** Knurled non-slip grip. 4"L.

**J0021L** **Lyss OB Handle.** Convenient to hold and make it easy to change position on the OB wire. Stainless steel. Sold individually. 3"L.

**J0022** **Pig Obstetrical Forceps.** Danish model. These forceps open sideways, making it practically impossible to catch the uterine lining. The piglet is gently grasped either around the head or the hips. No need of inserting your hand to place the instrument. 23"L.

**J0022a** **Puppy OB Forceps.** Stainless steel. Same design as J0022. 8"L. (not pictured)

**J0022h** **McLean Whelping Forceps.** For small breeds. 8"L.

**J0024wh** **OB Chain.** Plated. 45".  
**J0024ws** **OB Chain.** Plated. 30".  
**J0024wL** **OB Chain.** Plated. 60".

**J0024gs** **OB Chain.** Stainless steel. Finest available. 30".  
**J0024gL** **OB Chain.** Stainless steel. Finest available. 60".

**J0024x** **JorVet Calving Strap.** High quality tubular nylon strap with "D" ring. This strap is less traumatic to the unborn calf than steel chains. Royal blue. 1"W.

**J0024xL** **60" Strap** with 2 "D" rings.  
**J0024xs** **30" Strap** with 2 "D" rings.

**J0023s** **OB Chain Handle.** Stainless steel.

**J0024t** **T-bar OB Handle.** Allows for use of both hands for pulling. Handle 22cm L.

**J0024w** **Moore's OB Chain Handle.** Stainless steel.

**J0024wm** **Chain Handle.** Stainless steel with plastic laminated handles for easier grip.



J0024 OB Chain



J0024xL



J0023s

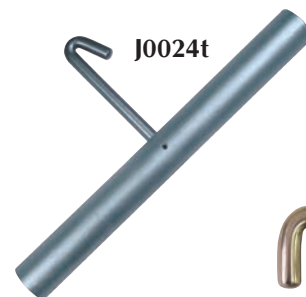

J0024t

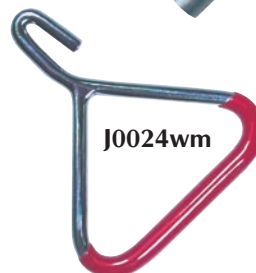

J0024wm



J0024w

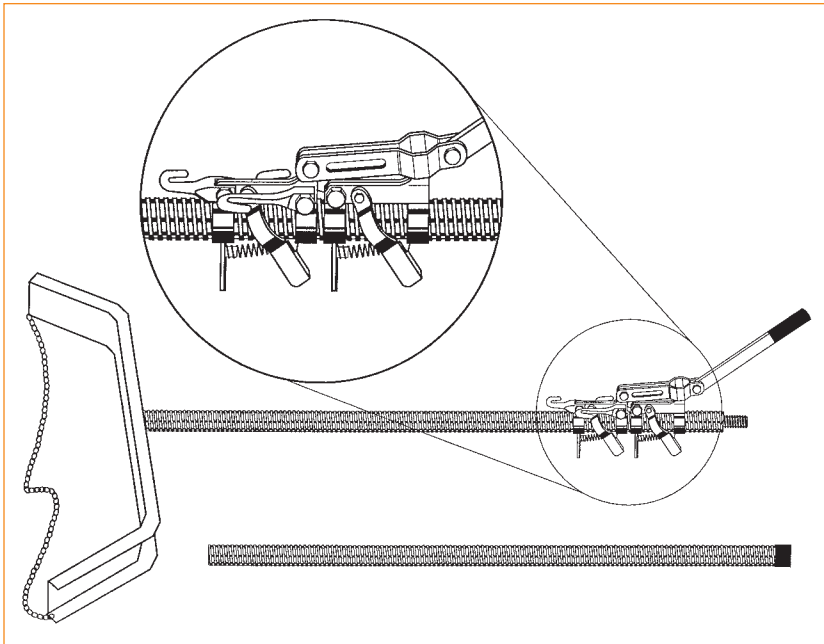

**J0099 Hercules Fetal Extractor.** This calf puller provides an entirely new approach to difficult calvings. With one of the handles you can move the two separate hooks alternately, pulling first one limb and then, with the next movement of the handle, the other limb. The most difficult presentation can be zig-zagged out in this manner. The extra- long 65" no-slip shaft disassembles in the middle. Breech is supplied with an adjustable, easy-to-clean chain.

**J0099c Canvas Calf Puller Case.** (not pictured)

**J0099e Economy Calf Puller.** This unit has a design similar to the Hercules calf puller, but costs considerably less.

*NOTE: Individual replacement parts are available. OB chains sold separately.*

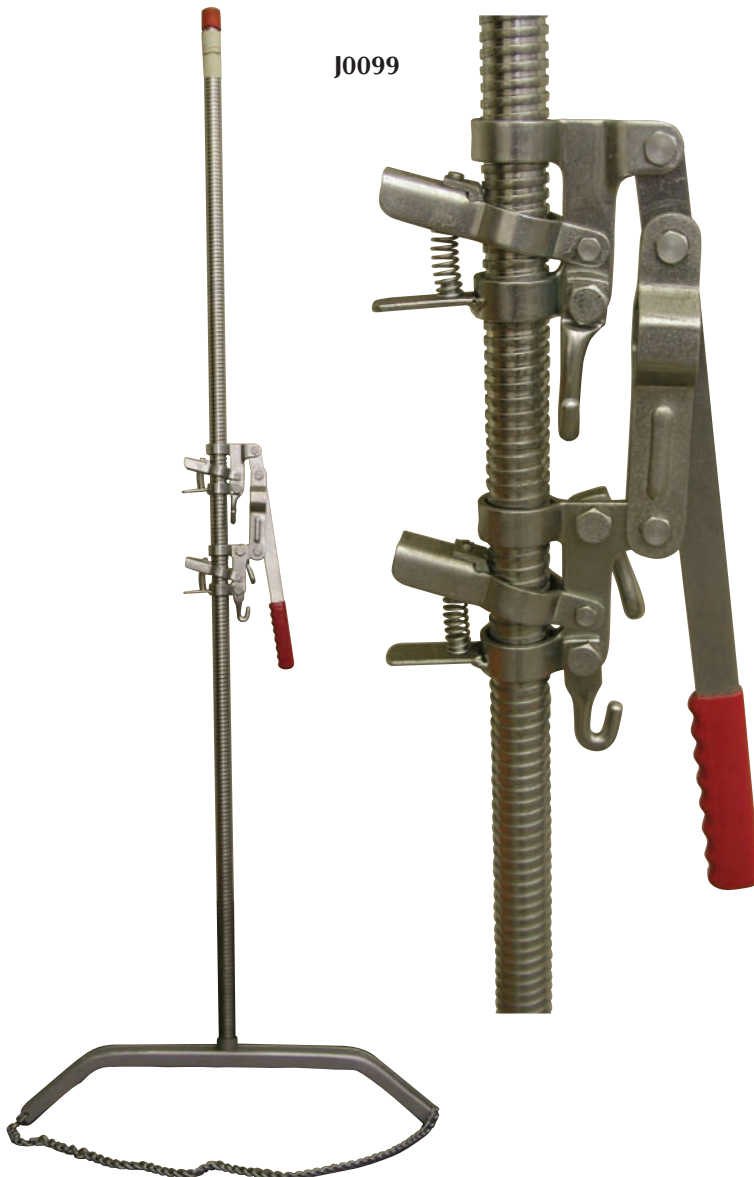

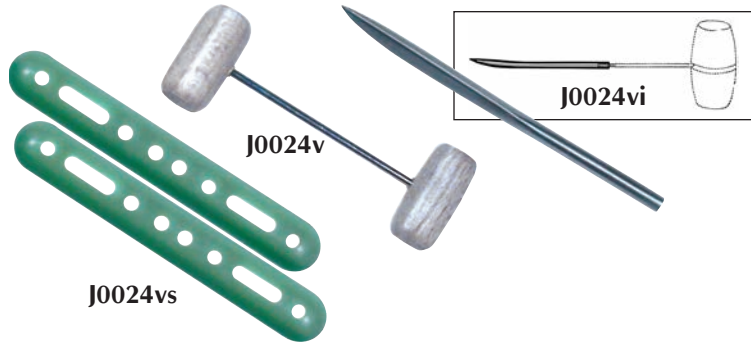

**J0024v Vulva Suture Pin.** 70mm. For repair of bovine uterine or vaginal prolapse.

**J-24vi Vulva Suture Pin Insertion Needle.**

**J-24vs Vulva Suture Pin Spacer.**

**J0025 Perivaginal Suture Tape.** To be used according to the Dr. Buhner method for treatment of a prolapse of the uterus or vagina. This special woven oval-shaped tape has histophilic features that permit a heal-in without irritation. Directions for use upon request. 4.5 meters.



J0025



J0025u Series

**Braided Umbilical Tape.** Polyester tape in plastic bottles.

**J0025ua Umbilical Tape.** 1/8" x 20 yds.

**J0025ub Umbilical Tape.** 3/8" x 20 yds.

**J0025uc Umbilical Tape.** 1/4" x 20 yds.

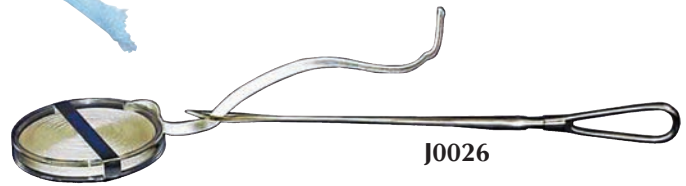

J0026

**J0026 Dr. Buhner's Needle.** For use with **J-25** tape. Stainless steel. 12".

**J0026g Gerlach Needle.** Similar to **J-26**, but only 6"L. For use in sheep and goats. (not pictured)

**J0026en Ewe Protainer Prolapse Retainer.** **New and Improved** prolapsed retainer from New Zealand. The old-style retainer was held in place by umbilical tape tied to wool. This new variation features locking clips at the end which are clipped onto the wool. Protainer is applied in seconds, 100% secure, and can be easily removed. Does not interfere with lambing and can be left in place for extended periods.

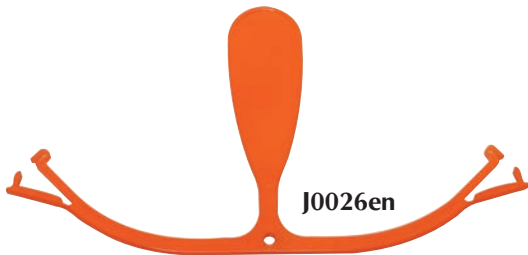

J0026en

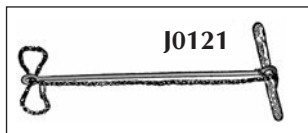

J0121



**J0121 Cornell Detorsion Rod.** Used in bovine uterine torsion. Stainless steel. (chain not included) 31 1/2"L.



J0921

**J0921 Lambing Aid.** Small plastic snare with "Y" configured head. Nylon covered steel cable. Helps in holding the lamb's head until the feet can be reached.



J0359

**J0359 JorVet Prolapse Kit.** A kit for the correction of preparturient vaginal prolapse. This kit consists of 2 large buttons connected with a plastic rod that retains the vagina in place. Calving can take place with no interference. Detailed instructions included.



The **JorVet Freemartin Probe** is a newly developed vaginal probe to detect freemartin heifers and/or determine if heifers born co-twin to a bull have a normal reproductive tract.

The crucial probe end length is 7cm. Research has shown that no freemartin calf has a vaginal length longer than 7cm.

The distal end of the narrower center section is 14cm from the tip. Over 95 percent of heifers born co-twin to a bull and with a normal reproduction tract have a vaginal length of 14cm or more. Animals with a vaginal length of 7-14cm should have chromosome testing done to confirm if a freemartin.

This probe is designed to be used on heifers 30 days or less of age.

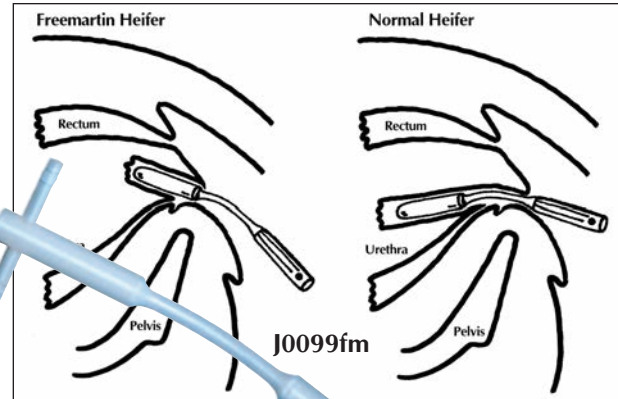

**J0099fm JorVet Freemartin Probe.**

**J0099s Calf Snare** (Cable type). Useful in difficult calvings for pulling a retracted head forward or from preventing the head from turning back during delivery. 26"L.



**J0022c Swine Cable OB Snare.**

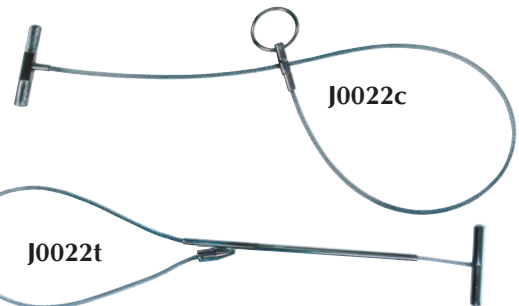

**J0022t T-bar Sow OB Snare.** 10"L shaft.



**J0099k The Kramer Curve** is a jaw snare that allows a veterinarian to relieve a dystocia more easily, especially those with a head that is presented below the brim of the maternal pelvis. Once attached, it is designed to fit over the veterinarians shoulders so that a downward turned head can be manipulated without assistance. This means that traction force and timing is entirely up to the person with their hand in the cow and on the fetus. This avoids the situation where and assistant pulls too forcefully or at the wrong time. Pulling force is much more easily generated by merely holding onto the snare handle and standing more upright, greatly reducing any pulling effort with an arm.

**J0109 J-LUBE®** is a concentrated powder that dissolves easily in water and is a very effective obstetrical lubricant. J-LUBE® is completely inert and non-irritating. 10 oz. plastic bottle with shaker top makes 6–8 gallons of lubricant. **For veterinary use only!**



**J0109**



**J0099k**



**J-Jelly.** An ideal all around lubricant for rectal and obstetrical procedures. Contains methylcellulose.

**For veterinary use only!**

**J0109f J-Jelly.** 8 oz. reusable flask.  
**J0109jb J-Jelly.** 1 gallon. (not pictured)

**J0781 OB Lube.** This small sterile lube packet is great for lubing up a vaginal speculum or anywhere a small amount of sterile lube is required, especially OB work. Non-spermicidal. Easy open 1 oz. packet. 12/case. **For veterinary use only!**



**J0109f**

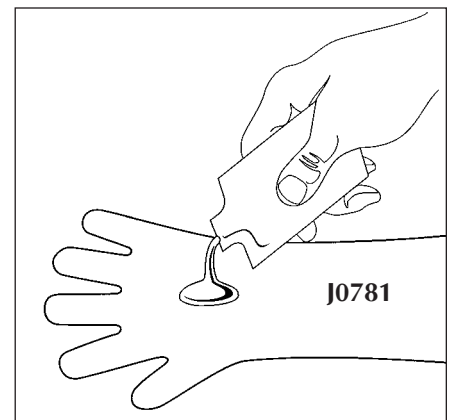

**J0781**



JorVet offers a variety of **Culture Swabs** to meet any need. All JorVet culture swabs are individually wrapped and packaged sterile.

**J0272** **Guarded Culture Swab.** The most popular style of culture swab. A hinged guard or cap covers the tipped swab. This bullet-shaped tip allows easier insertion and protects the swab from contaminants. Swab material is Calcium Alginate. 28" L flexible rod compares in style to Kalayjian™ brand culture swabs. 25/box.



J0272

**J0273** **Double Guarded Culture Swab.** This swab is protected by two outer plastic sheaths and a cap. The outer sheath and cap are penetrated after the swab passes the cervix into the uterus. The swab is scored so its length can be reduced and then covered with the two included caps for storage or transport. 33" L. 25/box.

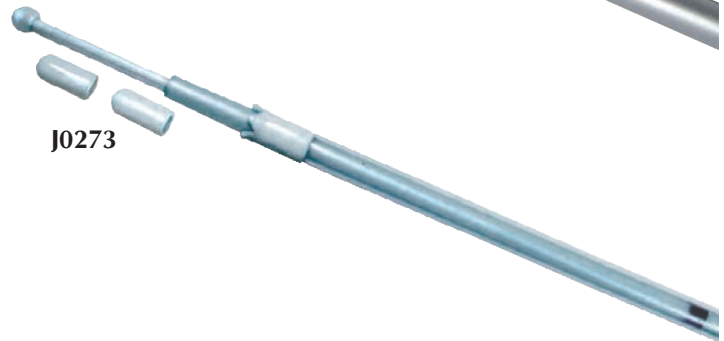

J0273

**J0273c** **Sterile Uterine Cytology Brush.** The use of a cytology brush is very common in female human patients. This cytology brush is a standard human cytology brush that is adhered to a culture swab insertion rod. It has the same double-guarded configuration as the J-273. 10/box, length 29".



J0273c

**J0274** **Tieglund Modified Culture Swab.** The original uterine culture swab. Swab is covered with outer flexible plastic tube. After the culture is taken, a scored ring 3 1/2" from the end allows the tube to snap off and is plugged with two included plastic caps. This allows for ease of transport and storage. 33" L. 25/box.



J0274

**J0102** **JorVet Small Animal Artificial Insemination Kit.** A complete kit for the veterinarian for the collection of semen and insemination of the female.

Features:

- Latex collection cone
- Four vaginal pipettes
- 12cc syringe
- Small plastic cap for end of syringe
- Cone holder
- Direction sheet
- J-Jelly lubricating gel, 8 oz. flask

**J0102d3** **Extra Long K-9 AI Pipettes.** 9". With blue syringe adapter. Pack of 12. Nonsterile.

**Bull Collection Cones.** Can also be used for K-9 collection.

**J0102d1** **AI Latex Cone** for bull semen collection. X-Large size.

**J0102d9** **Disposable AI Cones** for use in collecting bull semen. 100/pk. (not pictured)



J0102 AI Kit

J0102d1 latex cone

**J0123 Equine Breeding Bag.** Heavy latex rubber.



**Colorado Style Equine Artificial Vagina.** This is a light-weight A.V. in a complete kit with natural latex liners and plastic disposable liner. Also has collection bottle and filter. Comes with complete instruction manual. Many parts will interchange with other CSU or Colorado A.V.'s. Detailed literature upon request.

- J0125av Complete Equine A.V.**
- J0125avd1 Latex Inner Tubular-Shaped Liner.**
- J0125avd2 Latex Collection Liner.**
- J0125avd3 Disposable Plastic Liner.** 25/pk.





J0287a

J0287c



J0287d

J0287b



J0271



J0286p  
J0286s

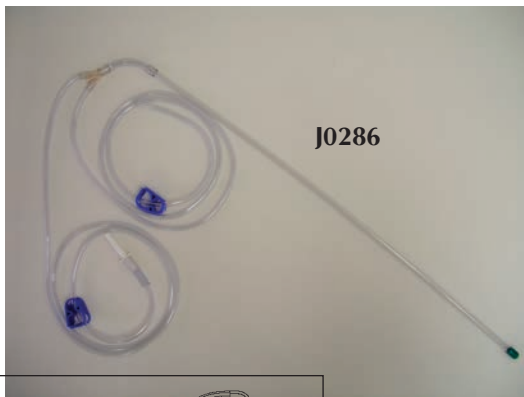

J0286

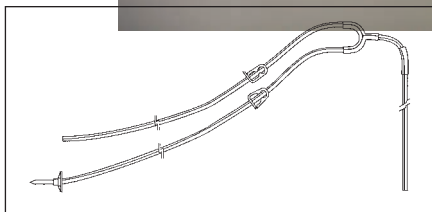

**JorVet Uterine Infusion Tube.** High quality PVC pipette with rounded polished insertion end to prevent tissue trauma. Large bore, manufactured with the following specifications; 0.160 i.d. x 0.225 o.d. for infusing viscous fluids. All tubes 25/poly bag.

- J0287a **18" Infusion Tube.** Syringe not included.
- J0287b **18" Infusion Tube** with drilled end. Syringe not included.
- J0287c **21" Infusion Tube** with flexible syringe adaptor. Syringe not included.
- J0287d **21" Infusion Tube** with drilled end. Syringe not included.
- J0287e **21" Drilled Pipette.** Individually wrapped. Sterile. 25/pk.
- J0287f **21" Pipette with Flex Adaptor.** Individually wrapped. Sterile. 25/pk.
- J0284 **Equine Sterile Uterine Infusion Pipette.** An equine-specific 25" pipette with extra-large bore adaptor to allow quicker infusion. Individually wrapped. Sterile. 25/case. (Syringe not included.)

J0271 **Sterile Disposable Vaginal Speculum.** Exterior surface is silicone-coated and one end is rolled smooth for ease of insertion. The interior surface is lined with aluminum foil for optimum light reflection. Individually wrapped. Sterile. 1 1/4" dia. 18"L. 50/case.

J0286p **Large Bore Pipette.** 1/4" x 25". Non-sterile. Over 2 times the diameter of J-284 pipettes. 25/bag.

J0286s **Large Bore Pipette.** 1/4" x 25". Sterile. Individually wrapped. 25/bag.

*NOTE: These pipettes can connect to standard size IV tubing with **J0282d1** luer/barbed connector or **J0597** female luer to male catheter tip connector. Also, attaches to the **J0400p** and **J0400q** large (3- and 6-liter) IV bags, allowing custom mixing of large volume lavage solutions.*

J0286 **Equine Uterine Lavage Kit.** This extra-large bore semi-rigid clear pipette has a very high flow. Sterile. 1/4" x 25"L.

- Dual 60" fluid line with spike on one end
- Shut-off clamps on each side of "Y"

Jorgensen Laboratories features only the finest in **Protective Apparel** for the veterinarian. All rubberized OB apparel in the **J0029** and **J0030** series features heat-sealed seams. Disk-type arm openings make for easy cleaning.

**J0029** **OB Shoulder Protector.** This is the original Danish import, where the arm passes through an opening in the special easy-to-clean rubber shield. There's no bunching of the material in the arm area. If worn in conjunction with a rubber apron, it serves as an OB smock. Protector ties under opposite arm.

**J0029a** **Rubberized OB Apron.** Suitable for wearing in conjunction with **J0029** or **J0029c**, as pictured. 120cm (48"L).

**J0029c** **OB Shoulder Protector Cuff** (left section of photo). Basically the same as **J0029** above, but less area is covered. Very handy in conjunction with disposable or rubber sleeves.

**J0030r** **Rubberized OB Smock.** This smock features the special easy-to-clean arm shields. Very durable. S, M, L, and XL. (not pictured)

**J0030o** **Rubberized OB Overalls.** Easy to snap-on suspenders. S, M, L, and XL. (not pictured)

**J0030csr** **Rubberized OB CoverAll Suit.** One piece. S, M, L, and XL. (not pictured)

**J0030sr** **Rubberized OB Suit.** With pants and jacket. S, M, L, and XL.

**J0030jr** **Rubberized OB Jacket** only. S, M, L, and XL.

**J0030pr** **Rubberized OB Pants** only. S, M, L, and XL.

**J0300d** **Yellow Super Touch Protector.** The "Total" OB Sleeve. This new product gives additional coverage to the whole shoulder and under arm area. No need for clamps to hold in place or a separate shoulder protector. Helps reduce laundry expense and reduces accidental manure stains and smell. This glove is sensitive but strong, 1-ml thick with strong smooth seams. Package is 50 sleeves in a pull out dispensing box.

**J0300ds** **OB Sleeve.** These gloves were developed for small hands for a tighter fit. Same style as above.

**J0100** **Vet-R-Sem Disposable Gloves.** This very popular glove fits your hand with no overlapping finger ends. Seams are very low and stretch well. The veterinarian's choice for sensitivity and strength. 1.35ml. Extra long: 35". Clear. 100/zip lock bag.

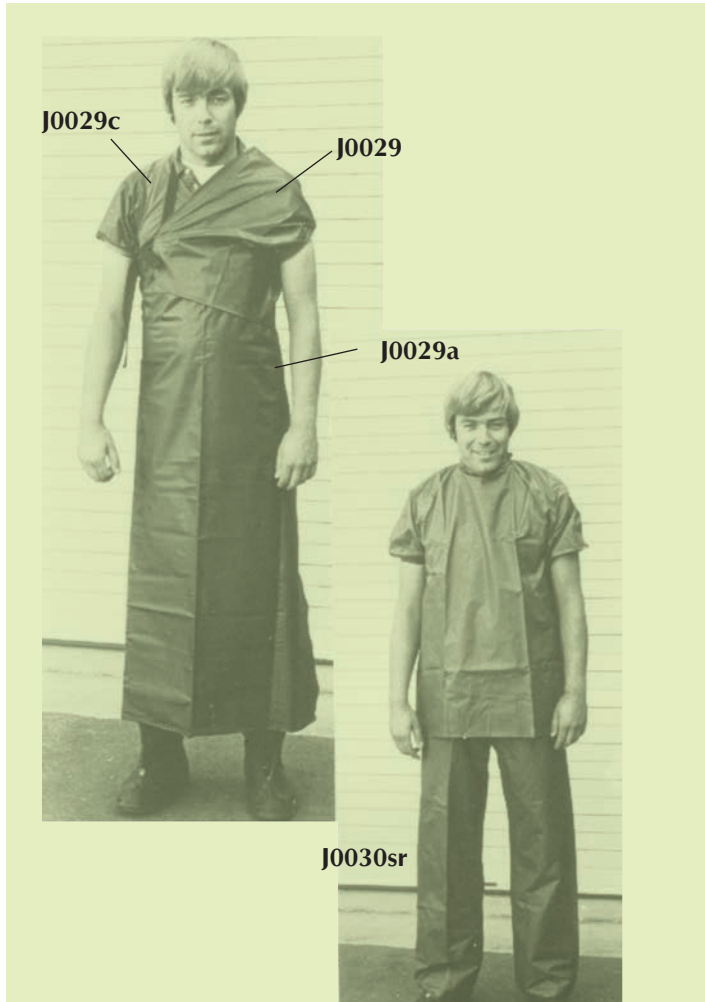





J0100d



**J0100d “Krutex” Disposable Gloves.** Amber. 100/box.

**J0100ds “Krutex” Disposal Gloves, Small.** These gloves were developed for small hands for a tighter fit. Amber. 100/box.



J0100b and bL

**J0100b Disposable Plastic Boots.** Help cut down disease transmission. 4ml. 50/pk. 18”H x 14<sup>3</sup>/<sub>4</sub>”L.

**J0100bL Extra-Long Boots.** Fits over cowboy boots and large work shoes. Handy tie feature keeps boots on tight. Blue. Heavy 4 ml thickness. 21”H x 16”L. 50/bag.

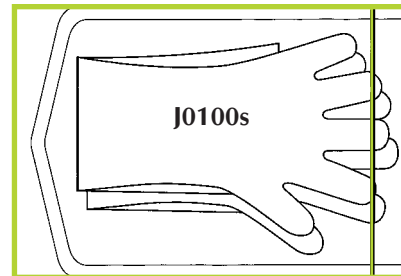

**J0100s Sterile OB Sleeves.** Disposable plastic shoulder length OB sleeves, packed in any easy open chevron pouch. Amber. Two sleeves per pouch. 5 pouches/pkg.

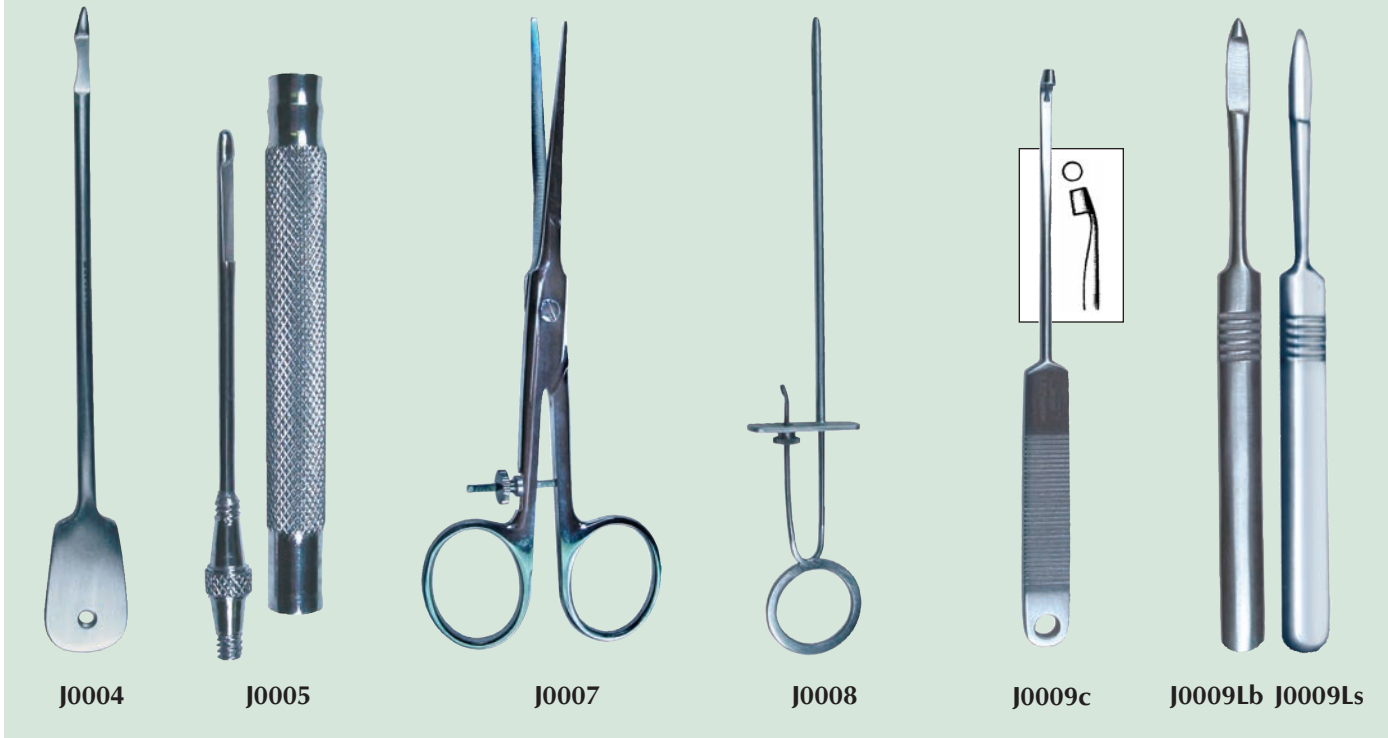

- J0004 Hug's Teat Knife.** Blade 1/2". Stainless steel. 6"L.
- J0005 Popular Danish Model Teat Knife,** with the short cutting and probe point. The blade can be unscrewed when not in use and immersed in a disinfectant placed in the hollow handle. Stainless steel.
- J0005s Teat Knife.** Probe point with hook. (not pictured)
- J0007 Christensen Teat Scissors,** with cutting edges on the outside of the blade; adjustable opening. 6"L.

- J0008 Teat Slitter.** Extra thin model. Blades are opened by loosening the small burr on the side of the instrument. 7 1/2"L.
- J0009c Cornell Teat Curette.** Stainless steel. 6"L.
- J0009Lb Lichty Teat Knife.** Blunt. Stainless steel. 5 1/2"L.
- J0009Ls Lichty Teat Knife.** Sharp. Stainless steel. 5 1/2"L.

- J0370k California Mastitis Test Kit (CMT).** JorVet offers an introductory kit for mastitis detection and control. The CMT measures somatic cell counts through a special reagent in a four-chambered paddle.
- Kit includes:** Paddle, 0.5-liter empty pump bottle, 1-pint concentrated CMT liquid, and directions with color charts.
- J0370p CMT Paddle** only. With instructions.
- J0370L CMT Test Liquid.** 1-pint concentrate makes 1 gallon.



**Mastitis Test X-Purt.** CMT can now be done with a one hand operation. The 300ml X-purt reagent reservoirs (10 oz) acts as a handle. Milk is put in each paddle chamber (about 3ml or 0.1 oz). A quick squirt of reservoirs inputs equal amounts of test solution into each chamber. Swirling for usual coagulation recognition. Color Chart included. Reservoir bottle capacity will test about 15 cows. Just refill from CMT liquid (J-370L).

- J0370X** complete
- J0370XD1** replacement/extra reservoir bottles



**J0010 Teat Blades.** These blades are designed with a specially shaped cutting edge inside the hook, making a cut in the sphincter in a manner that the outside opening of the teat canal remains whole. Stainless steel. 6/pkg.



J0010

**J0011b Teat Tumor Extractor.** With two cutting edges that come together for removal of fibrous tissue. 4.5mm dia.

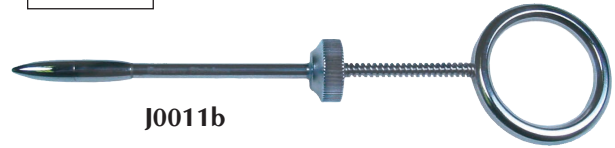

J0011b

**J0012 Teat Infusion Cannula.** Fits any syringe. In handy tear-off strips. 1 1/3" L. 100/pkg.



J0012

**J0012d Plastic Teat Dilators.** 100/pkg.  
 • Soft comfortable fit  
 • Individually packed in handy cellophane tear-off strips  
 • Familiar diamond shape

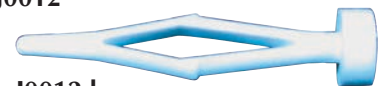

J0012d

**J0012x Short nozzle teat cannula.** 4mm shaft length. This is a shorter teat cannula for customers preferring not to pass through the streak canal into the teat cistern like conventional cannulae do. 100pk in tear off strips. Sterile.



J0012x

**J0013 Dr. Irvin's Shurflow Plastic Teat Tubes.** For cows with injured teats. Each self-retaining tube is packaged individually in a small vial. When tube has been inserted, it fits nearly flush with end of teat. No irritating thornlike protrusions (as found in other teat tubes on the market) are necessary to keep tube in place. 36/card.



J0013z

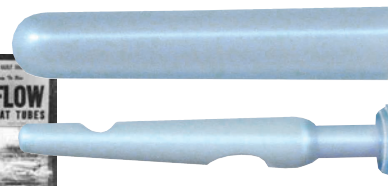

J0013

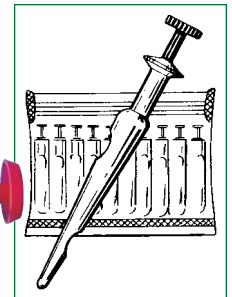

**J0277 Udder Infusion Cannula.** Cannula used for infusing medication into teats. Luer adaptor. Nickel-plated brass. 12/pkg.



J0277a

**J-277a** 1 1/2" with one opening.  
**J-277b** 2 1/2" with two openings.  
**J-277c** 3 3/4" with two openings.  
**J-277bs** 2 1/2" with two openings. Stainless steel. (peritoneal taps)



J0277b

**J0014tb Teat Bandage.** Teat injuries are serious problems and until now have been nearly impossible to properly bandage. The JorVet bandage is a cohesive polyester bandage that makes it easy to provide a protective bandage over an injured teat. 2 1/2" W x 15'L.

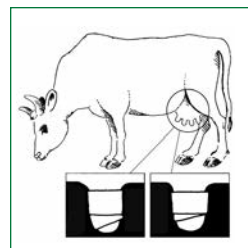

J0014tb



**J0013L** **Extra-Long Teat Tubes.** Brass stylett is left in tube only during insertion for stiffness. Plastic, flexible, and self-retaining. Sterile. Unit separately packaged in cellophane bag. 3”L. 12/pk.



J0013L

**J0014L** **Dr. Larson’s Teat Tube.** This is the original Dr. Larson plastic teat tube. Also useful in treating small animal ear hematomas. Sterile. Individually packaged on a display card of 36 tubes.

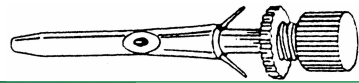

J-14L

**Milk Tube.** Self-retaining. Smooth retaining bulbs. 12/pk.

- J0278a** **Milk Tubes.** One lateral eye. 2”.
- J0278b** **Milk Tubes.** Two lateral eyes. 2 1/2”.
- J-278c** **Milk Tubes.** Two lateral eyes. 3”.



J0278a

J0278b

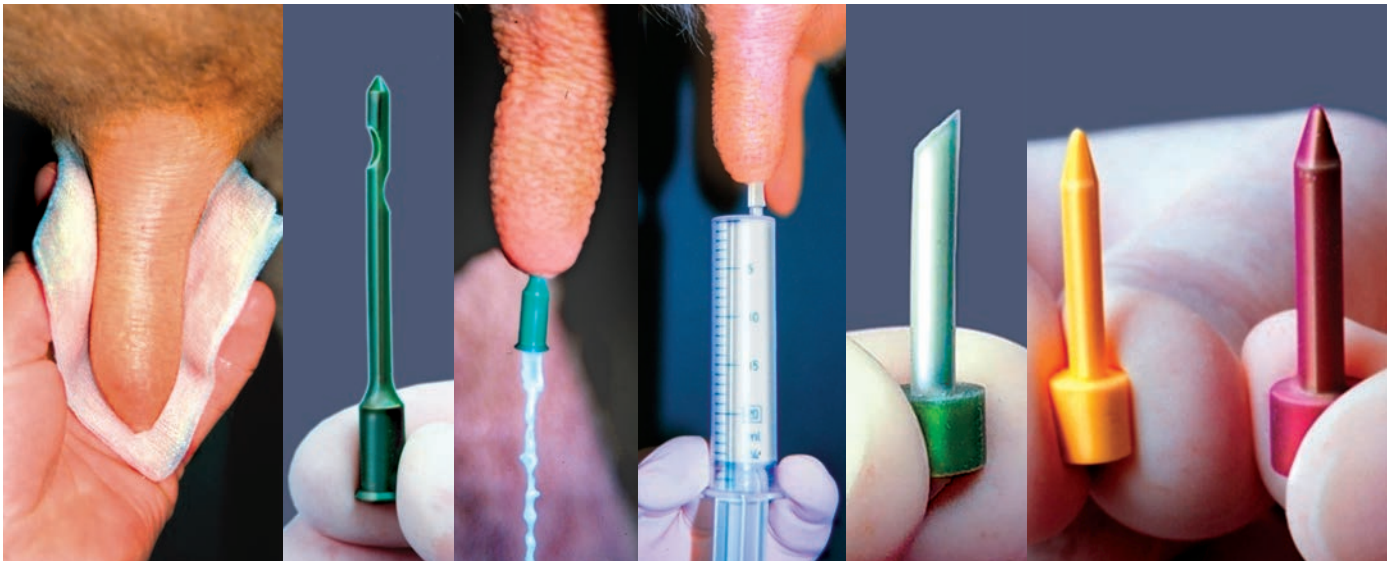

Clean & Wash Injured Teat

Plastic Teat Infusion Cannula

Drain Teat

Infuse Antibiotic

NIT Insert

SIMPL Teat Implant

J0905

J0903

J0904

**Teat Injury Treatment.** Covered or closed teat injury can be caused by being frozen, stepped upon or other trauma. A new system of conservative and natural treatment of closed teat injuries has been developed in cooperation with a European Veterinary School.

The initial treatment consists of drainage of milk and antibiotic infusion with sterile flexible plastic udder infusion cannula.

NIT (Natural Insert for Teats) Teat Dilator. This short dilator consists of a natural waxy material similar to the teat’s natural sebum. The teat is bandaged with teat bandage (J-14tb). This NIT dissolves after several days.

Later in the treatment regime a sterile soft flexible silicon implant is used to maintain teat canal patency.

- J0905** **Plastic Sterile Teat Infusion Cannula.** 10/pk.
- J0903** **NIT Natural Sterile Waxy Teat Insert.** Foil packaged. 20/pk.
- J0904** **SIMPL Soft Flexible Sterile Silicon Teat Implant.** Foil packaged. 20/pk.
- J0014tb** **Teat Bandage** (see page 30).





J0040p



J0040om

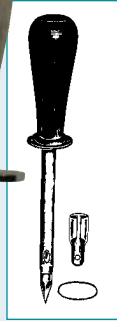

J0040rt



J0040f

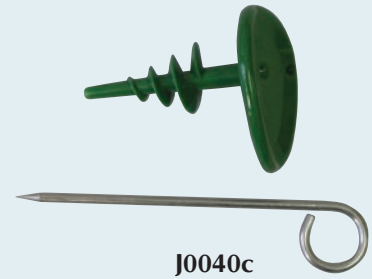

J0040c

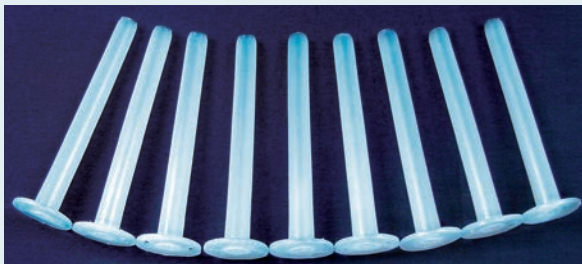

J0040pc



J0110sL

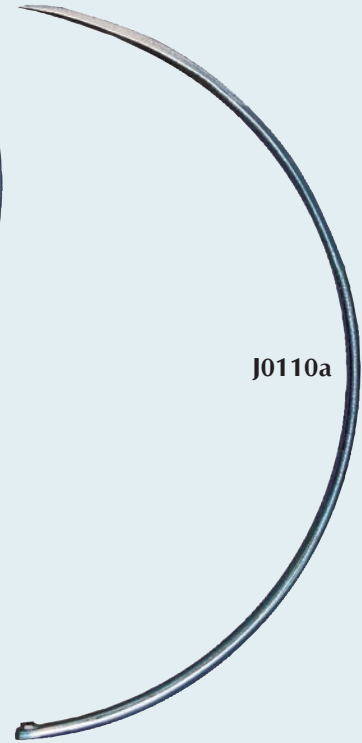

J0110a



J0110sm

- J0040om** **Oval Bloat Trocar** with metal handle. The flat, oval shape has made this trocar very popular. It pierces the hide easily without any pre-incision. Includes cannula and protector.
- J0040f** **Corkscrew Trocar.** This is the self-retaining bloat trocar used in chronic bloats. Make a small  $\frac{3}{4}$ " incision in hide. Screw the trocar into position. After insertion, the rumen should be pulled up close to the peritoneum by placing a few wraps of gauze between the trocar plate and hide.
- J0040c** **Buff's Corkscrew Trocar** with metal stylet.

- J0040pc** **Disposable Plastic Cannulae** only. Holes in cannulae allow suture attachment. 10/pk.
- J0040rt** **Round Metal Trocar** with wood handle. 5" metal portion with 2 cannulas and one protective cap.
- J0110sL** **Large Double-Curved Needle.** 5". 12/pk.
- J0110sm** **Medium Double-Curved Needle.** 3 $\frac{1}{4}$ ". 12/pk.
- J0110a** **DA Needle.** Tapered 8" curve tip to tip.
- J0110b** **DA Needle.** Reverse cutting 8" curve tip to tip.
- J0110du** **Drost Uterine Suture Needle.** This 3" straight atraumatic needle is used to make a minimal perforation into the uterine wall and, when kept parallel to the uterus surface, prevents penetration into the uterine lumen and the formation of potential small fistulas. Not pictured.



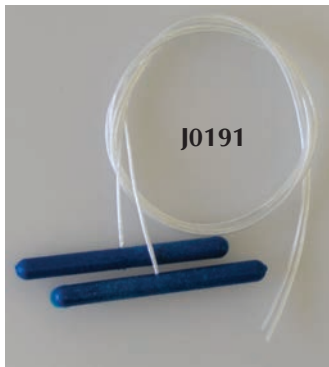

J0191

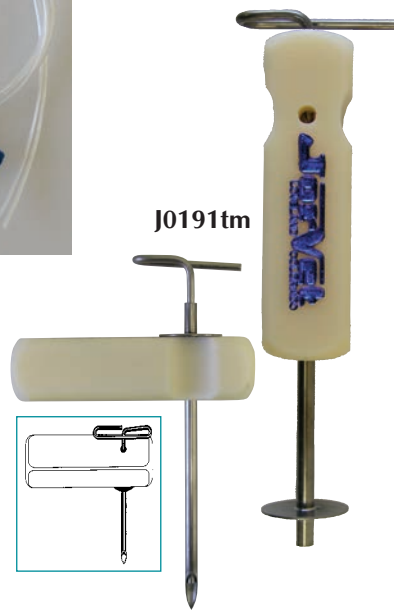

J0191tm

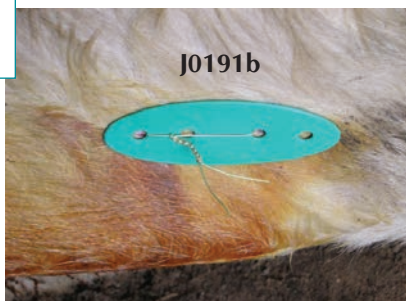
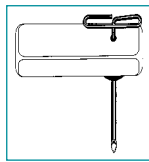

J0191b

The **J0191tm Trocar/Cannula** and **J0191 Toggle Sutures** are used in the Grymer/Sterner method for nonsurgical percutaneous fixation of the left displaced abomasum (LDA).

For viewing the actual surgical technique check the website [www.ldatogglesuture.com](http://www.ldatogglesuture.com).

**J0191 Toggle Sutures** sold in pairs.

**J0191tm Trocar Cannula**

**J0191b Toggle Suture button.** This suture button has a number of different applications in bovine surgery the most common being LDAs. It is a flat pliable oval shaped disc with four round contoured holes. It helps reduce suture tension by distributing the pressure over a wider surface area.

Suggested uses:

- LDA toggle button repair
- Uterine/vaginal prolapse repair
- Umbilical hernia in calves

Measures 4" Long x 1<sup>5</sup>/<sub>8</sub>" Wide x 1/16" Thick

- 6 buttons/pack
- Neon green color for easy observation
- Complete directions included

Visit [www.ldatogglesuture.com](http://www.ldatogglesuture.com) for more information



J0900rf

The **Selekt Rumen Collection system** is an innovative device that allows the user to collect a large volume of rumen fluid to test the pH or contents. Also, if needed, the collected sample can be transferred to another cow.

**J0900rf Selekt Rumen Collection system.**

Consists of:

- **J0900hs short hose**, 60cm (connects to the bottom of the pump)
- **J0900pu pump** only
- **J0900cc steel collection chamber**
- **J0900hL long hose** for collection, 3.25m
- **J0900ht nose tongs**
- Pump adaptors

- J0036w** **White's Modified Emasculator** with extra crushing area. Stainless steel. 12".
- J0036ws** **Small White's Modified Emasculator**. Stainless steel. 8". (not pictured)
- J0036e** **Even Crush Emasculator**. Extra crushing area moves as crushing takes place. Stainless steel. 12".
- J0036g** **Sand's Castrator**. Crushing only. Stainless steel.
- J0036p** **Hausman Standard Emasculator**. Stainless steel. 12".
- J0036fs** **Frank's Emasculator**. Stainless steel. 7 1/2".
- J0036s** **Small Emasculator**. Stainless steel. 7 1/2".
- J0037** **Reimer Emasculator**.
- J0037c** **Reimer Emasculator**. This very popular emasculator has a double crushing part. The cutting lever is worked separately. This allows extra time for crushing action and diminishes afterbleeding. Stainless steel. 12 1/2".
- MOST POPULAR**
- J0037h** **Hauptner Reimer Emasculator**. Chrome.
- J0036hd** **Heavy-Duty Elastrator** for applying latex bands used in tail docks and castration. Metal, 22cm (8 1/4") L. **For veterinary use only.**
- J0036b** **Latex Elastrator Bands**. High quality latex bands. 100/bag. **For veterinary use only.**

**Warning**

Castration is a surgical procedure. It should be performed by a veterinarian or under the training or supervision of a veterinarian.

Improper technique or after care may result in infection, bleeding, herniation, or even death.

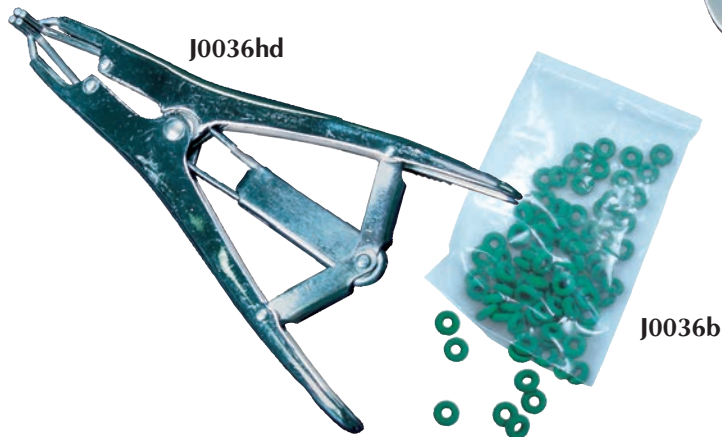
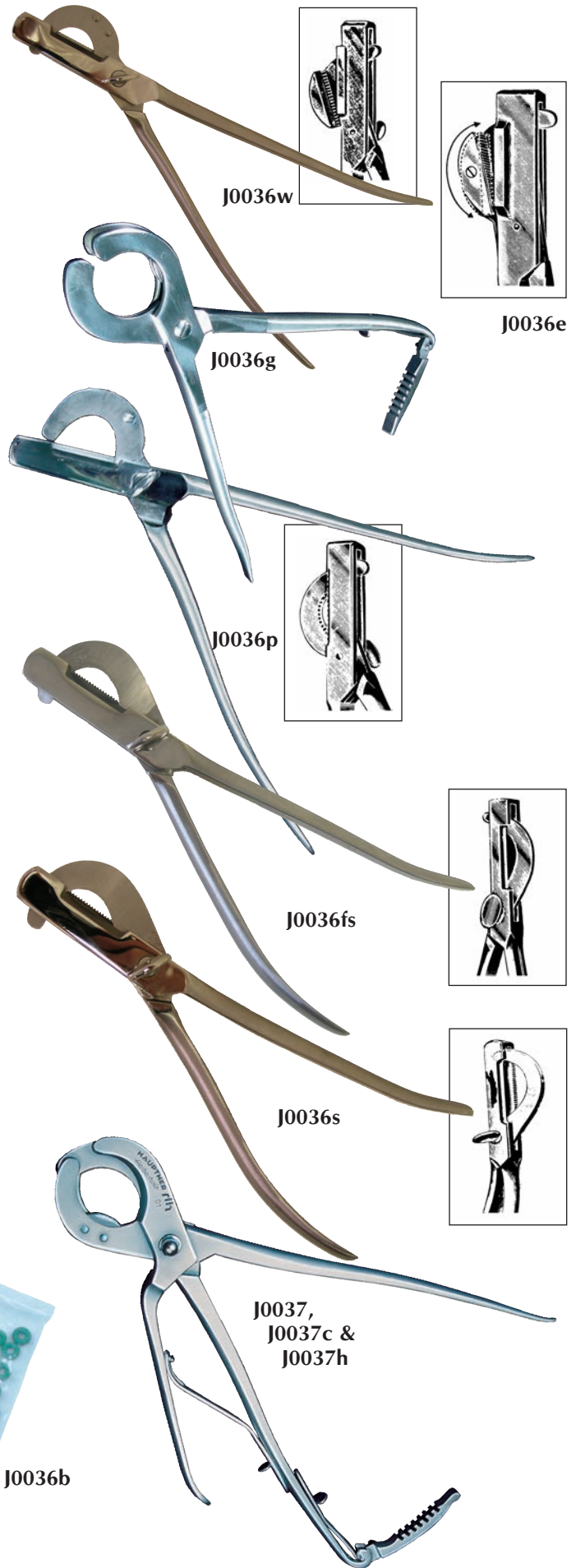

**J0037sa** **Serra Modified Emasculator.** Hauptner's finest emasculator, excellent for equine work. For one-hand use. A concave cutting plate draws the cord concentrically into the jaws of the castrator, whereby slipping of the cord is avoided. The cord and surrounding strands are centrally gripped, pressed together and cut through. Reduces tissue slippage and post-op hemorrhage. Chrome. 14".

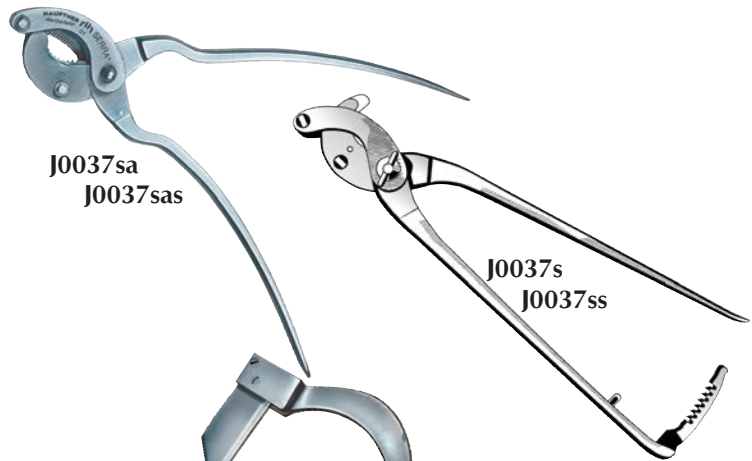

**J0037sas** **Serra Modified Emasculator.** Stainless steel. 14".

**J0037s** **Serra Emasculator.** This instrument draws the cord concentrically into the jaws, thus preventing slipping of the cord. Hemorrhage is reduced to a minimum. Ratchet holds emasculator lock, as in J-37. Chrome. 14".

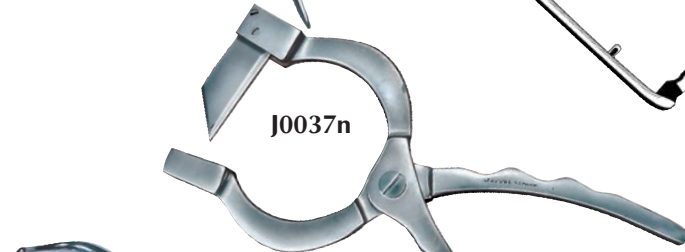

**J0037ss** **Serra Emasculator.** Stainless steel.

**J0037n** **Newberry Castrating Knife.** Stainless steel. Will split the scrotum for easier removal of testicles. 10<sup>1</sup>/<sub>2</sub>"L. (Blade is non-replaceable.)



**JorVet Emasculatome.** With cord stop for bloodless castration. Includes wrench on all models.

**J0037ema** **Emasculatome.** 9".

**J0037emb** **Emasculatome.** 12".

**J0037emc** **Emasculatome.** 14".

**J0037emd** **Emasculatome.** 16".

**J0037eme** **Emasculatome.** 19".



**J0037k** **Knee Brace** for large models.

**J0037e** **Ecrasseur.** This is the popular ratchet type ecrasseur by Chassaignac. Stainless Steel. German-made. 19".



**J0037c** **Reimer Emasculator** s/s M09. 12<sup>1</sup>/<sub>2</sub>"L. European made.



**J0087** **Serrated, Curved Spay Scissors.** 12".

**J0087L** **Serrated, Curved Spay Scissors.** 16" for flank approach in spaying heifers.

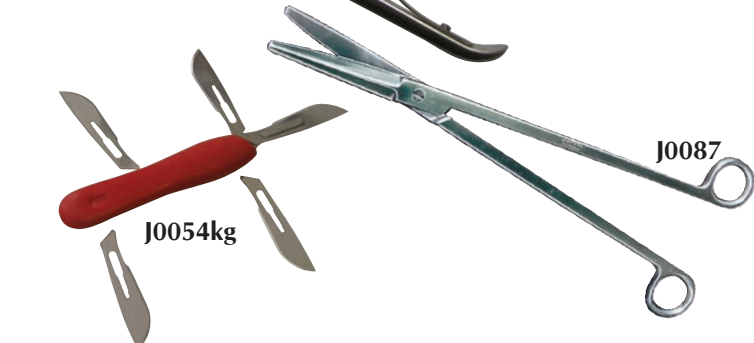

**Castration Kit.** Scalpel handle together with 6 sterile scalpel blades. On a display card

**J0054KG** #22 blades with large red nylon handle

**J0054KC** #12 blades with large red nylon handle





**J0062s** **Roaring Burr.** For use in equine laryngeal hemiplegia (roaring). French model with hooks. 8 1/2"L.

**J0062st** **Strawberry Roaring Burr.** 8 1/2"L.

**J0088a** **Parker's Tenotome Knife.** Small, blunt and curved 15 x 3mm blade.

**J0088bc** **Tenotome Knife.** Blunt and curved 5cm x 1/2cm blade.

**J0088bs** **Tenotome Knife.** Blunt and straight 5cm x 1/2cm blade.

**J0088sc** **Tenotome Knife.** Sharp and curved 5cm x 1/2cm blade.

**J0089** **Tendon Splitter.** Double edged blade. Stainless steel. 4cm L blade.

**J0726g** **Sterile Guttural Pouch Culture Swab.** Getting a culture or cytology sample from the equine guttural pouch is a real challenge. The conventional swabs do not have the proper angulation for entry into the guttural pouch.

This 22" culture swab is bent to about a 30° angle. After the sample is obtained, it can be removed with the outer sheath still in the guttural pouch. Then medication can be infused if found necessary.

The swab is covered by a methylcellulose plug prior to entry and to avoid contamination. 5/pk. (not pictured)

**J0027g** **Chamber's Equine Catheter.** Stainless steel with slightly curved tip. Finger rest, luer slip adaptor. The preferred instrument for flushing the guttural pouch. Also can be used for uterine flushes. 8g. 22"L.

**J0639** **Broncho-Alveolar Lavage Catheter.** This catheter is designed to perform lavage on the equine lung. The BAL catheter can also be used for cytology or culturing the airways. The catheter is inserted nasally. The cuff inflated when in position. A 3-way stop cock is used for administration and aspiration of fluid.

- The stiffness of the catheter makes for ease of passage
- 30fr (10mm) x 240cm L
- 10cc cuff

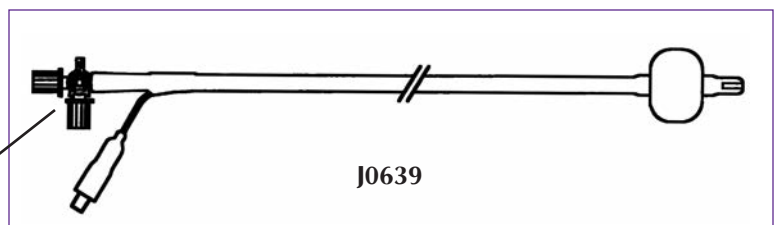
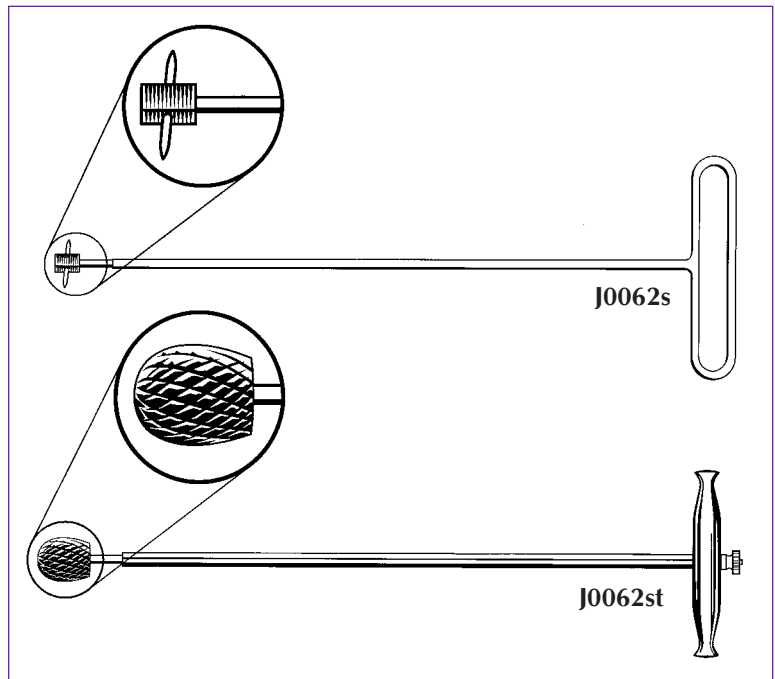

Note: 3-way stopcock not included

**J0281 Equine Colostrumeter.** Many tests are available to equine practitioners for evaluating the newborn foal's IgG serum level, but this is the only practical and economical test available for evaluating the mare's colostrum.

The JorVet Equine Colostrometer utilizes only a small 15ml sample of the mare's colostrum by comparing the specific gravity to distilled water in a plexiglass hydrometer. From the specific gravity obtained, a determination can be made whether or not the foal will be receiving colostrum with adequate IgG concentration. Another benefit is if the colostrum specific gravity is fairly high, up to 250cc can be frozen for a colostrum bank.

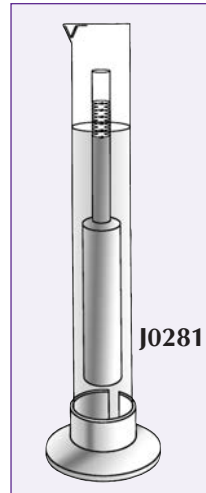

**J0281d1 Glass Hydrometer.**

**J0281d2 Hydrometer Cylinder.**

**J0283 Equine Tracheal Wash Kit.** Transtracheal wash is a very useful diagnostic tool in the treatment of lower respiratory disease in horses. The JorVet Tracheal Wash kit provides a convenient and easy method to obtain high quality diagnostic samples. The procedure is simple to perform under light sedation with a small local block over the lower third of the neck. Sterile.

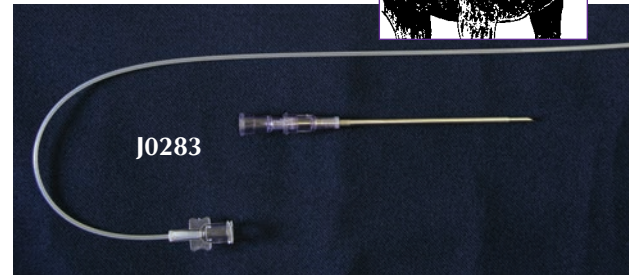

- 15g cannula and 16g needle
- Catheter 22"L

**Equine Abdominal Peritoneal Tap.** Heavy-duty stainless steel construction makes this the preferred cannula for abdominal taps in horses. 12/pkg.

**J0277bs Peritoneal Tap.** 2 1/2" shaft with two lateral openings.

**J0040ek Equine Trocar/Cannula.** Suggested use for cecum puncture. Very small 3mm dia. x 135mm (5.4") shaft.

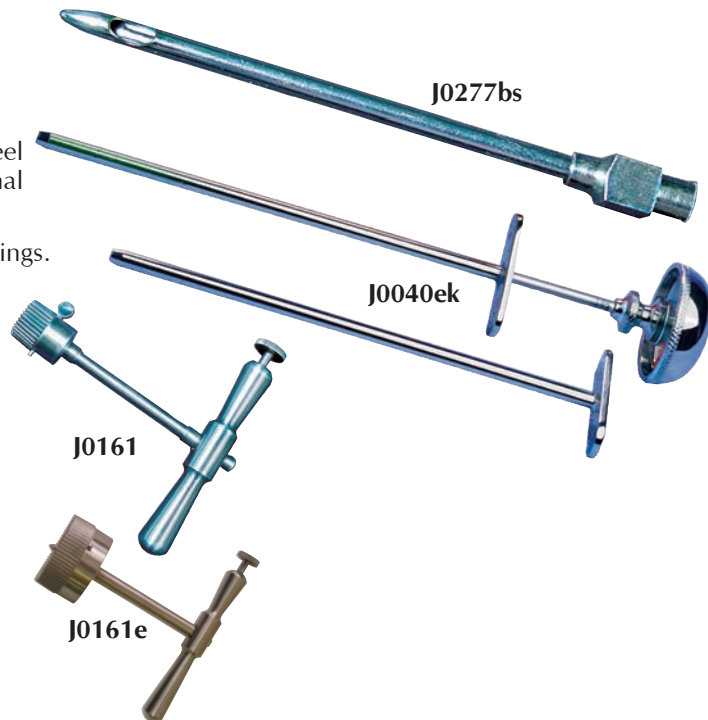

**Horsley's Trephine.**

**J0161a Trephine.** 1/2" i.d.

**J0161b Trephine.** 3/4" i.d.

**J0161c Trephine.** 1" i.d.

**J0161e Equine Sinus Trephine.** 2" The trephine has been designed for use on a modified frontonasal sinus flap surgery.

**Equine Padded Recovery Hood.** This protective hood is a valuable tool in the prevention of head trauma such as facial nerve paralysis to any horse under going anesthesia. The thick yellow closed cell foam padding has openings for eyes, ears, and muzzles. The area around the eyes is double padded. Adjustable strap for proper fitting.

- J0473 Neonatal foal hood
- J0473a Foal/yearling hood
- J0473b Standard hood
- J0473c Warm blood/draft hood



**J0844 Equine Haler** is a reusable inhalation “spacer.” The one-way valve allows the medication to be passed only when the horse inhales. It can be easily cleaned for continued use.

The inhalation device has been developed specifically for accurate administration of pharmaceuticals to horses with inflammatory respiratory diseases including chronic obstructive pulmonary disease (i.e., recurrent airway obstruction, or RAO). The Equine Haler provides a convenient method of administering all available types of metered dose inhalers (MDI) to horses. The MDI delivers the medicine at a suitable particle size, (<5 microns) for direct distribution to the small airways. Developed in Denmark and tested at the Centre for Equine Studies, Animal Health Trust, Newmarket, UK.

One treatment takes 1-2 minutes.



J0844

**Equine Enteral Fluid Therapy Concept.** This kit finally makes giving equine enteral fluids an achievable procedure.

Enteral therapy advantages

- Considered a better alternative than IV in treating large colon impactions, dorsal displacement of the colon and severe diarrhea cases
- Less expensive than IV treatments
- Cost of fluid is less
- Reduced labor
- Previously not a readily available technique



**J1190 The kit** utilizes a

- Modified large bore IV set with coil tubing
- Modified foal size stomach tube 9mm x 2.6m
- Dual 5 liter collapsible containers
- Muzzles 3 sizes and Velcro to hold placement
- Balanced electrolyte powder: dilute with tap water (36)

- J1190a Complete kit less electrolyte packets
- J1190b Replacement kit less electrolytes and muzzles/straps





**J0492m Tomahawk Universal portable x-ray cassette holder.**

This hand held positioner safely holds 8x10", 10x12", and 14x 17" cassettes for a wide range of views and maintains safety by avoiding exposure to the x-ray beam.

Features:

- Lightweight aluminum weighs 2 1/2 lbs.
- Spring loaded clamp holds full range of cassettes sizes with easy changing
- Rotating grip handle telescopes in length
  - 2 handles provided:
    - Long handle 32"-54"
    - Short handle 0"-20"
  - Has non slip black plastic grip
- Center ground support leg also telescopes from 0-20" in height
- "Bubble" level on top helps give accurate position
- Folds up for easy storage in mobile vet units.

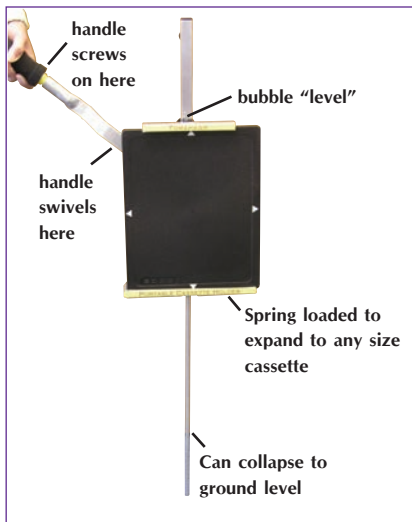

J0296

**J0296 The JorVet Equine X-ray Cassette Holder**

is a lightweight piece of equipment that allows the cassette to be held at any angle but keeps the person holding it out of the harmful X-ray beam. Will hold both 8" x 10" and 10" x 12" cassettes. 36" shaft. Quick-release clamp. Breakdown model for easy storage. 12"W x 42"L. 2 lbs.



**J0494m Radiograph Cassette Tunnel.**

Navicular and skyline shots are easy with this cassette tunnel plus it protects your delicate cassettes.

- Lightweight shatter resistant polycarbonate top with solid oak frame
- Bottom is lined with lead to prevent back scatter
- Holds 8" x 10" standard cassettes
- Tilting support base allow any angle change or up-right shots
- Non-slip surface
- Carrying handle







J0493x

**J0493x**

**Quick Shot.** This handy device holds the cassette at arm's length directly attached to the portable x-ray unit. The "Quick Shot" allows a single person to take films and eliminates need for assistance.

- Lightweight aluminum weighs only 2 1/2 lbs.
- Adjustable handle allows usage with all commercial portable x-ray units.
- Holds wide range of cassette and grid sizes
- No guess work in achieving proper focal lengths
- "Bubble" level mounted on top of the handle and side of the cassette holder
- Adjustment knobs allow positioning of cassettes at all angles
- Folds flat for easy storage
- Foam padded handle has holder for x-ray machine trigger
- Removes many positioning variables

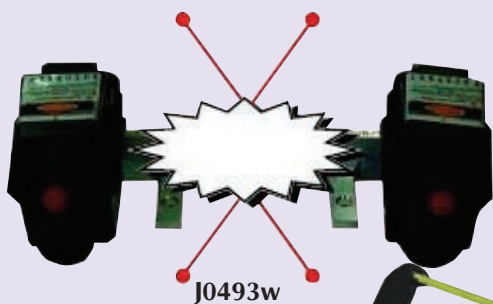

J0493w

**J0493w**

**Dual Laser Pointers.** Standard collimator white light is difficult to see in outdoor sunlight or even indoor light. This makes achieving the proper focal distance difficult.

This small dual pointer mounts on a portable x-ray unit. The twin beams cross at the preferred 26" film focal distance and can be seen in any lighting situation.

Uses standard watch batteries.

Laser pointers mount on almost all x-ray units



**J0492x Equine Foot Positioning Blocks.** These simple blocks elevate the hoof off the ground for better x-rays of the lower limb including evaluation of any P3 rotation.

- Lightweight, shatterproof, polycarbonate and wood construction
- Non-slip surface covered with special 3M material Radiopaque. Cross hairs giving geometric position indicator on the exposed film.
- Dual cassette holding slots for lateral and AP views
- Holds all sizes of x-ray cassettes
- Grid ready — has room in cassette slot to hold a grid if deemed necessary
- Attractive storage bag 12" L x 8" W x 10" H
- Block size is: 11" L x 7 1/4" W x 3 1/2" H



J0492x

**J0275 Equiprax Radiograph Positioner.** Equine practitioners know that consistent positioning and repeatable views are important for good diagnostic radiographs of the equine limb.

Clinical field situations often result in varying angles, distance, and exposure. Lesions (particularly on the navicular bone and the 3rd phalanx) can be obscured or eliminated by variations in the radiographic position.

The Equiprax Radiograph Positioner was designed by an equine practitioner to give consistent quality diagnostic radiographs. Allows for five different views.

Detailed literature available upon request.



J0275

**Redden Navicular Stand.** Getting consistent and repeatable navicular views is one of the toughest equine X-ray challenges. This design aligns all 3 factors—the machine, the hoof, and the cassette.

- Spacer bar holds X-ray machine at correct focal length
- Outstanding evaluation of navicular bone is possible through a 45° oblique view
- Stand is made of cast aluminium
- Stand will pay for itself the first two times you do not have to retake navicular views

**J0495rb Navicular Stand** only.



J0495r

**Thomsen's Universal Dental Float.** Float head is hinge attached, making this float universal for upper and lower molars. Float blade is concave from side to side, stays on dental surface. Long lasting tungsten carbide blade.

- J0058s** 20" Shaft, includes J-58ct blade.
- J0058L** 26" Shaft, includes J-58ct blade.
- J0058ct** Curved Float Blade with tungsten carbide chips, fits universal float.

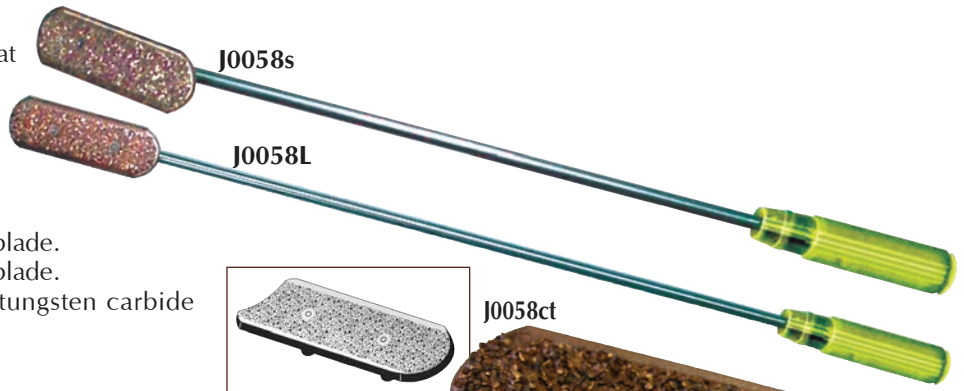

- House Combination Dental Float.** Stainless steel.
- J0058hc** Standard Dental Float with both straight and angled shaft with one interchangeable handle. 20"L.
  - J0058ha** House Float Angle Shaft only.
  - J0058hs** House Float Straight Shaft only.
  - J0058hh** House Float Interchangeable Handle only.
  - J0058hq** Float with handle and Straight Shaft.
  - J0058hz** Float handle with Angle Shaft.



*NOTE: The above are supplied without blades — use flat blade.*

**Carbide Float Blade.** These blades take alot of the work out of floating a horse's teeth. The carbide metal is very hard and gives a razor sharp edge. This is the new standard in equine dentistry. Blade can be resharpened 3 times. Available in 3 different grits: fine, medium, and coarse. Medium is the most common grit used. Fits any standard flat headed float. 3 1/4" x 1".

- J0057** Float Blade. Medium grit.
- J0057c** Float Blade. Coarse grit.

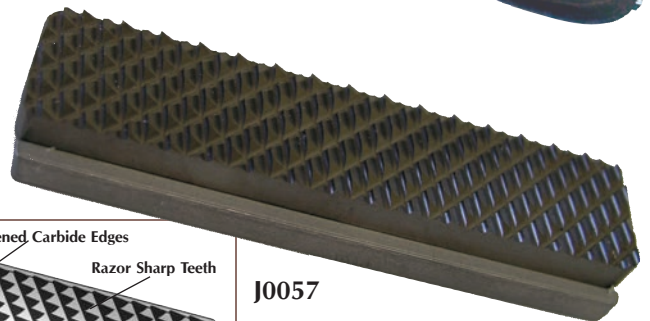
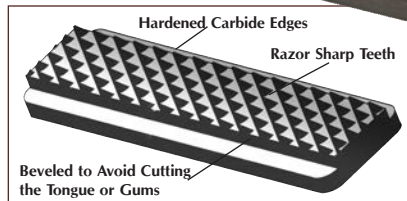

**Short Flat Blade** for specialized floats (i.e., bit seat float). 2 1/4" x 1".

- J0057sf** Flat Blade. Fine grit.
- J0057s** Flat Blade. Medium grit.

- J0058ft** Flat Float Blade with tungsten carbide chips fits any standard float. 1 3/8"OD x 1 13/16"ID x 19.5"L.





**Premium Float Line.** These floats are a quality crafted stainless steel float line with many new configurations to employ the newest techniques in equine dental care.

- Flat shaft provides visualization for blade orientation
- Lightweight and precision balanced
- Non-slip hand grip, colored coded end
- Large Allen head set screw
- Fits standard flat float blades
- Combined with (J-57) hardened carbide float blade makes for the finest floating equipment available
- Blade not included

**J0496 Straight Molar Float.** 13 1/2" shaft.

**J0496a Offset Molar Float.** Excellent for rear molars. 13 1/2" shaft.

**J0496b Angle or Obtuse Float.** For use on upper arcade molars. 11 1/2" shaft.

**J0496c Premolar Float** with short right angle shaft. Especially effective on premolar hooks and special "bit" requirement.

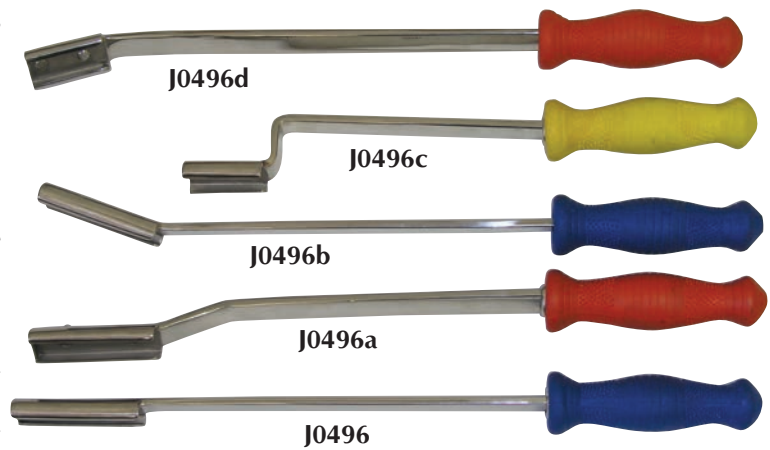

**J00496c:** NOTE: Must use short series blades (i.e., J0057s series).

**J0496d Rear Molar Float.** Specially designed for dropping over and onto the last molar and removal of hooks that can develop on the caudal edge of that tooth. 13 1/2" L shaft.

**J00496d:** NOTE: Must use short series blades (i.e., J0057s series).



**J0496drp Dental Rasp Protector.** Designed to fit or be inserted into J-398b stainless steel bucket. Separates and protects rasps while soaking in the bucket.

**J0058p Proctor Float** makes it easy to float the first two premolars. Tungsten carbide chips. 12" L.



**J0702 "S"-Shaped Hand Rasp.** This is especially useful as a finishing tool on the upper premolars. Tungsten carbide. 30cm L.







J1048f



**J1048**

**Equivet magnetic dental float.** A totally new approach to a float blade attachment to the handle. These floats have a magnetic head that holds securely the solid carbide blade. The blades can be removed with a "T" bar handle punch. The blades are a very sharp solid carbide with rounded corners. Hollow shaft lightens weight. The shaft is flattened at its attachment to the handle. This gives the operator orientation on the blade location.



J1048e



J1048d



J1048g



J1048c



J1048a



J1048b

- J1048 a upper cheek #8-#11
- J1048 b lower cheek #6-#11
- J1048 c upper and lower last molar #1
- J1048 d upper and lower teeth molar #6 or pre-molar roller for creating a bit-seat
- J1048 e upper premolar teeth #6-#8
- J1048 f upper and lower incisors/canine #1-#4
- J1048 g used with a convex shaped blade (J-57Y) for the occlusive surface
- J0057 y Carbide blade for J-1048g.
- J0057 xm Medium grit.
- J0057 xf Fine grit.
- J1048T T bar handle - blade punch.

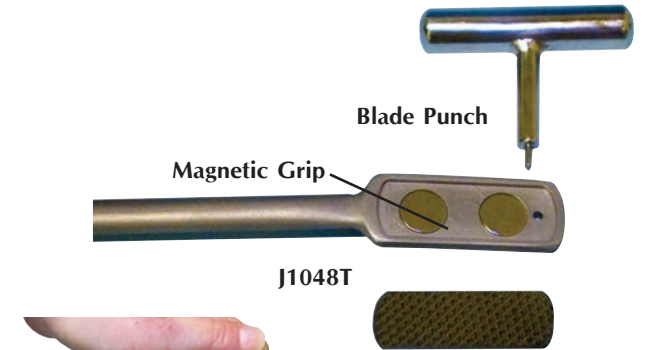

Blade punch removing blade from magnetic hold

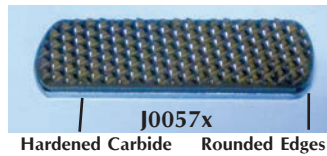

J0057x  
Hardened Carbide Rounded Edges



J0937h



J0937y

**Equine Dental Float with Pistol Grip.** These floats use a pistol grip handle that some practitioners prefer. Two set screws attach the tungsten carbide head. Choose from three float heads and two handle length options.

**Rasp, Straight - Complete**

- J0935 J0935h and J0937x
- J0935a J0935h and J0937y
- J0935h Replacement Rasp only. 1"W x 2"L.

**Rasp, Angled-Up Head - Complete**

- J0936 J0936h and J0937x
- J0936a J0936h and J0937y
- J0936h Replacement Angled-Up Rasp Head only. 1"W x 2"L.

**Rasp, Angled-Down Head - Complete**

- J0937 J0937h and J0937x
- J0937a J0937h and J0937y
- J0937h Replacement Angled-Down Rasp Head. 1" W x 1<sup>3</sup>/<sub>4</sub>"L.

J0937s Set of Straight, Angled-Up, and Angled-Down 30cm Rasps, with both lengths of pistol grip shafts. Six different configurations.

- J0937x Pistol Grip Handle, only. 30cm.
- J0937y Pistol Grip Handle, only. 42cm.

**J-38zm Meister Equine Mouth Speculum.** “The ultimate speculum for doing the right job.” Originally developed, designed, and patented by Dr. Jack Meister. This speculum is the gold standard for doing proper and thorough equine dentistry. A full mouth speculum. Stainless steel. Includes Biothane straps.

Improvements include ridge along ratchet to help avoid side slippage. Recessed areas in upper dental plate for placement of light source (J-38X) included. Caution should be used with all full mouth equine speculums. Be sure set-screw is set properly to prevent slippage.

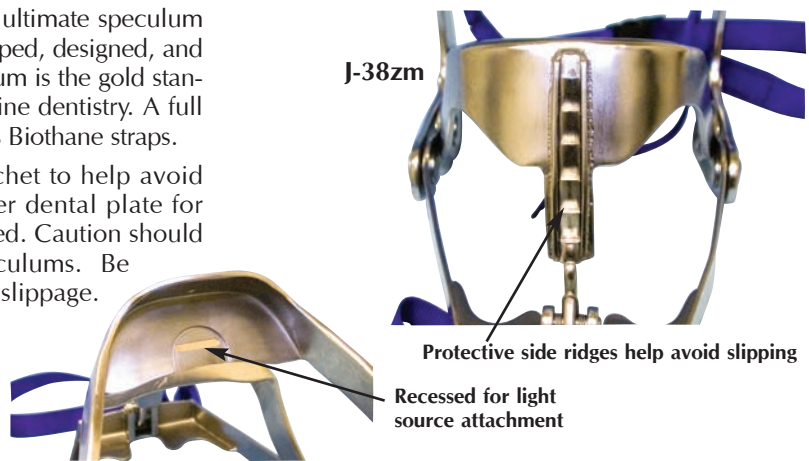

**J0914 Equi-Vet Dental Halter.** Especially useful for prolonged procedures. This special halter has a large, sturdy nose band made of a leather-covered round metal circle. A small ring is at each 90° for attachment of a support or restraint rope.



**J0038 Bayer Mouth Wedge.** This oral speculum is very handy when examining the oral cavity or doing dental work in equine. Stainless steel. “V”-shaped wedge with raised bumps to reduce slipping.

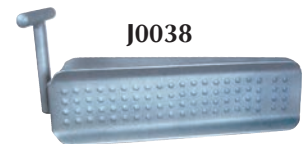

**J0038m Meier’s Dental Wedge.** Helps facilitate examination of the mouth and floating of teeth.

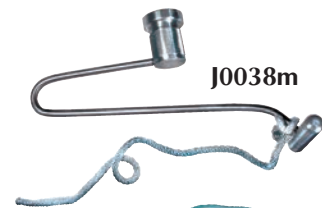

**J0038s Equine Speculum** by Schoupe. Reduces the danger of slipping with this instrument since it is held in place by the equine cheek area. Inserted without difficulty. It permits greater freedom in treating any part of the oral cavity. Tie rope included.



**J0038mps McPherson Mouth Speculum.** Full mouth gag for equine dental work. Comes complete with straps and tooth plates for upper and lower incisors. Stainless steel.

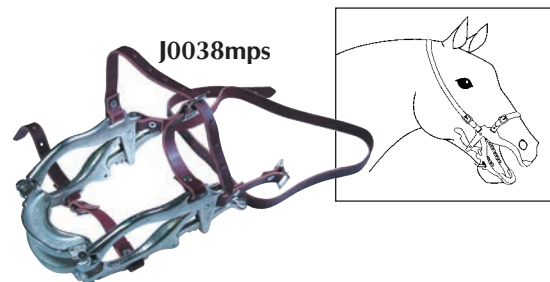

**J0038mpsp Pony Size Mouth Speculum.** Stainless steel.

**Equivet Mouth Wedge.** This design employs molded rubber blocks. These give an atraumatic cushion plus more comfort for the horse. The rubber block is simply replaced when worn. Stainless steel.

- J0038k Equivet Mouth Wedge.**
- J0038kb Replacement Rubber Block.**
- J0038kp Pony or Miniature Horse Mouth Wedge.** Same specifics as J0038k only smaller.
- J0038kpb Spare Rubber Block** for J0038kp wedge. (not pictured)





J0038g



J0042



J0699



J0712



J0713

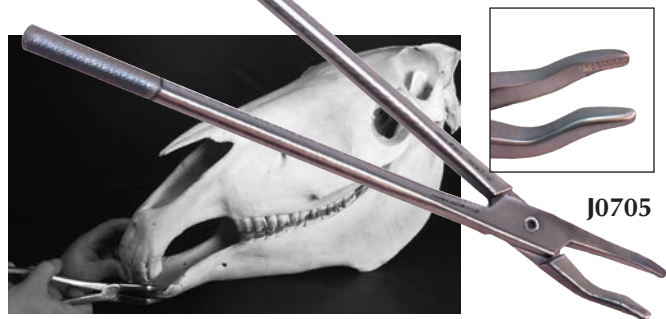

J0705

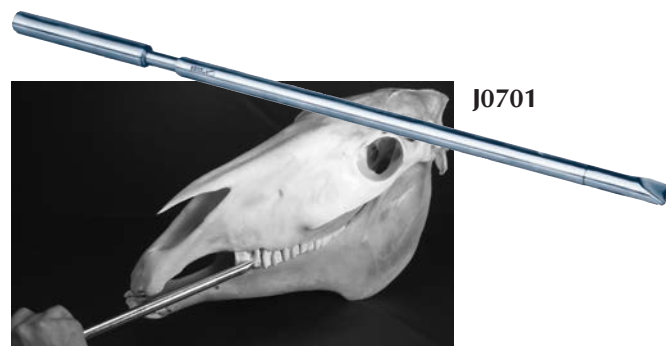

J0701

**J0038g JorVet Equine Incisor Speculum.** There are situations where it is only necessary to examine the incisors. This simple gag is placed in the mouth the same way as a bit in the interdental space. It creates easy access to the incisors. Heavy-duty, but comfortable rubber held in place by adjustable nylon rope.

**J0042 Equine Molar Cutter.** Powerful compound action. Breakdown model for easy storage. Stainless steel. 11<sup>1</sup>/<sub>2</sub>" handle. 25"L.

**J0699 Adjustable Head Lamp.** Proper lighting insures a better exam and diagnosis. This head lamp illuminates viewing area and is hands free. Focusable with standard and halogen bulbs. Operated by three AA batteries. Battery case on top of head.

**Dental Tooth Punch.** The punch is used for removal of cheek teeth through a trephined hole into the sinus. A knurled handle gives a better grip. A round head with a slight recessed area fits better onto the tooth. Stainless steel. 20cm L.

**J0712 Tooth Punch.** Straight.

**J0713 Tooth Punch.** Curved.

**J0705 Universal Small Tooth Extracting Forceps.** Stainless steel. 17"L.

**J0701 Dental Chisel** with sliding bar or percussion handle. The working end has a notched "V". It works great for removing upper premolar hooks and lower rear molar hooks. Stainless steel. 23"L, collapsed.





**J0043ab Burgess Wolftooth Set.** Two different head sizes allow this instrument to “cap” the wolf tooth. By rotating clockwise and counter-clockwise, the tooth can be separated from the alveolus. Angulated head is useful on teeth that are set well back. Stainless steel. 1/4” and 3/8” heads.



**J0043w Wolftooth Elevator.** The length of the blade can be shortened or lengthened as desired by loosening the set screw with the wrench.

**J0043wb Wolftooth Blade** only.



**J0043y Wolftooth elevator set.** This attractive professional looking kit has six different instruments to help elevate any size of wolf tooth.

Different elevators:

- 5mm sharp concave point with rounded backside, 6” length
- 5mm sharp concave point with a curved head, 6” length
- Large 9mm concave sharp head, 6” length
- Longer, heavier handle with a 5mm slightly curved deep concave head, 9” length
- Longer, heavier handle 5mm deep concave head, 9” length
- 9mm concave curved replaceable head on ergonomic curved heavy handle, 8” length
- All in handy, padded black zipper pouch with red velvet lining

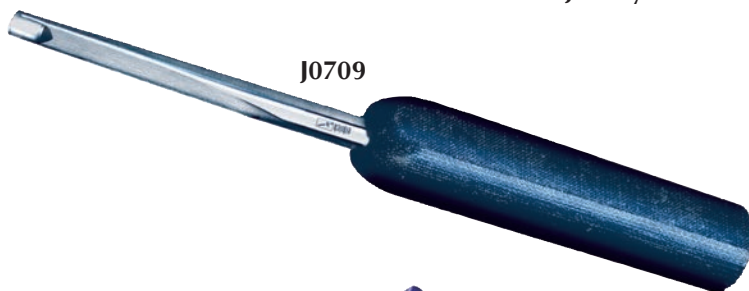

**J0709 Deluxe Wolf Tooth Elevator** with ergonomic handle. 22cm L.

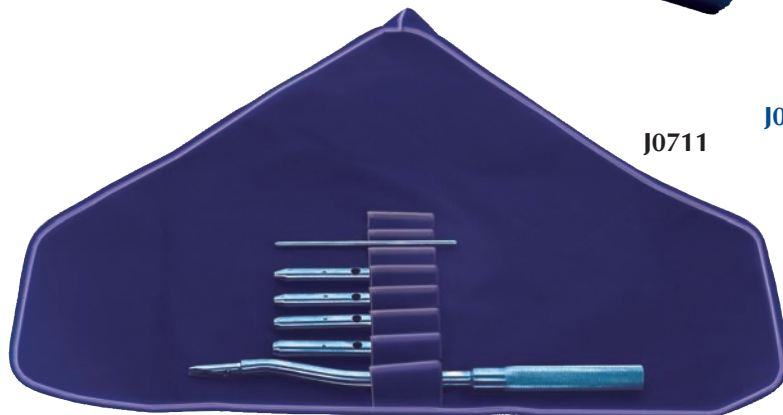

**J0711 Deluxe Wolf Tooth Extractor Set.** Includes four different sized interchangeable heads that fit completely around the tooth reducing chance of slipping and injuring the soft tissue or gingiva. Includes elevator blade for loosening tooth. Also can be used to remove tooth fragments. Comes in convenient canvas case.



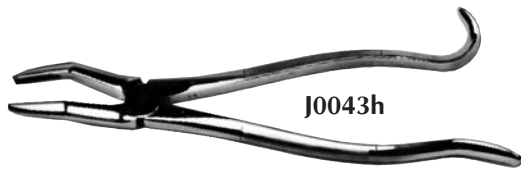

J0043h

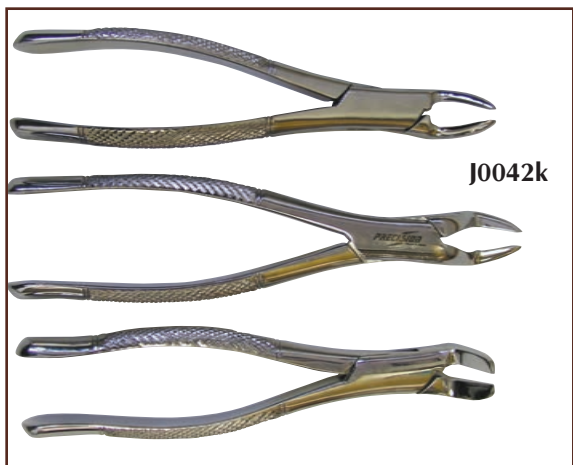

J0042k



J0043rL



J0043ru

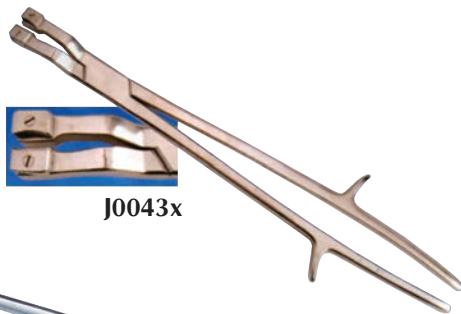

J0043x



J0704



J0938h

**J0043h Wolftooth Extractor Forceps.** Stainless steel. 11½"L.

**J0042k Small extracting forceps kit.** Useful for small wolf teeth and tooth fragments. One forceps is useful for spreading incisors before extraction. Set of three forceps configured with varied angled heads make it easier to extract wolf teeth or fragments out of tight spots. 7" length.

**Reynold's Equine Tooth Extractor.** This is the recommended instrument for retained deciduous teeth (caps) in horses. Also works for small premolars and incisors.

**J0043rL Extractor.** Lower Jaw. Stainless steel. 15"L (38cm).

**J0043ru Extractor.** Upper Jaw. Stainless steel. 15"L (38cm).

**J0043x EquiVet Cap Forceps** with flexible head. This cap retained deciduous teeth removal forceps gives a better grip as the heads swivel to fit the actual shapes of the cap. Universal for both upper and lower jaws. Stainless steel.

**J0704 Deciduous Premolar "Cap" Extraction Forceps.** Designed by Dr. Stelzer, German-made high quality forceps. Slightly curved. Stainless steel. 17"L.

**J0938h Hickey Equine Dental Cheek Retractor.** This retractor is very useful for pushing the cheek laterally away from the buccal aspect of the cheek teeth. It greatly improves visualization. It is used together with a full mouth speculum. 17" length x 1" width.

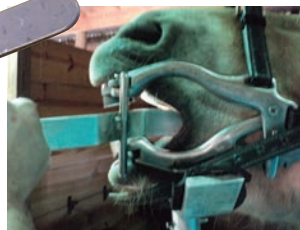

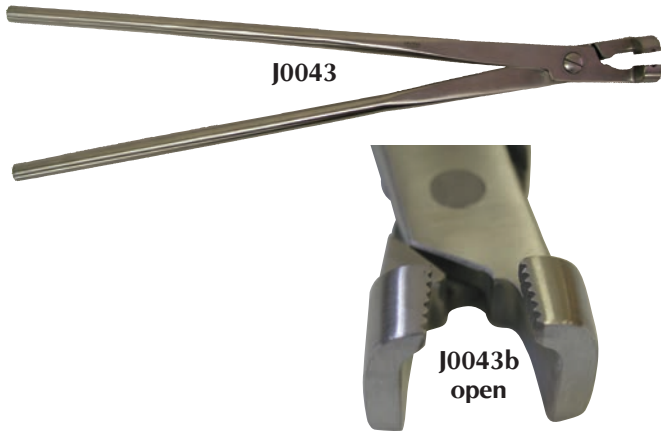

**J0043 Equine Molar Forceps.** High quality stainless steel. 17<sup>1</sup>/<sub>2</sub>".

**J0043b Molar extraction forceps.** Serrated short jaw creates good purchase on cheek and premolar retained deciduous teeth. These forceps have a shorter or smaller jaw surface than compared to the standard **J-43** Molar Forceps. Wide jaw surface. 21" length

**J0043bm Minimolar extraction forceps** with narrow serrated jaws. Shorter version at 12" versus 21" of J-43b. Short narrow jaw molar extraction forceps.



**Three Root Extracting Forceps.** These forceps have three slightly rounded grasping hooks: Two on the corners of one side and one in the middle of the opposing side. This design gives leverage in removing cheek teeth in older horses with diminished smaller crowns. Also, helps removing premolar caps in extracting the entire deciduous tooth.

The two-hook side of the extractor is placed on the outside of the tooth. The side with one hook is placed on the inside. This mimics the anatomical alignment of the tooth roots.

So, a three extraction forceps with a two hook on the right side (instrument facing up) and one on the left would be used on the upper left and lower right dental arcades. Also called "off" side.

A three root forceps with one hook on the right side and two hooks on the left side would be used on the upper right and lower left dental arcade. Also, called "on" side.

**Three root extraction forceps**

- J1092 On side 21"**
- J1092a Off side 21"**

**Smaller version in length and forceps head size**

- J1092b On side 12"**
- J1092c Off side 12"**

**J1093 Four root tooth extraction** utilize a four corner hook on shaped head 21"

**J1093a Smaller 4 root tooth extraction** in both length and head size 12"



**J0441f Equine Dental Fragment Forceps.** A special design to remove tooth fragments from the cheek tooth sockets. Compound action stainless steel 44cm right angled jaw.



**J0938** **EquiVet Cheek Spreader** pulls the cheek gently away from the cheek teeth so occlusion can be evaluated on a closed mouth. Also useful for providing more room when power float equipment is being used. By turning retractor around, you get two sizes. Stainless steel.

**J0938m** **EquiVet Dental Mirror.** Large mirror angled at 30°. "T" shaped handle. 19" length.

**J0939** **EquiVet Dental Pick.** Useful for probing or removing debris from in and around cheek teeth. "T" handle. Stainless steel. (48cm) 19".

**J0939a** **EquiVet Perpendicular Gingival Elevator.** Useful for exploring and elevating between teeth. "T" handle. (48cm) 19".

**J0939b** **EquiVet Parallel Gingival Elevator.** Useful for elevating the gingival prior to extraction.

**J0939k** **Set** of all three gingival elevators and picks in a blue nylon canvas carrying case. Comfortable Neoprene handle. Includes:

- J-939 dental pick
- J-939a perpendicular gingival elevator
- J-939b parallel gingival elevator

**J0225x** **Compound Rongeur.** Large 6mm bite is used to aggressively remove pieces of tooth. They bite with a strong compound action. Also, useful to remove heavy plaque from teeth. Slightly curved head. 9" length.



**J0939x EquiVet Dental Irrigation Pick.** This specially designed dental pick uses pressurized water irrigation through a long thin metal tube with a right angle end. Very useful in cleaning of inter-dental spaces and periodontal pockets. Connects to a water tank that, with a few simple pumps, creates a pressurized flow.

A large dental patient like a horse needs oversized equipment. These dental probes, scalers, and explorers are giant sized to 19" with knurled handles. If you do a lot of equine dentistry, you are going to find them very useful.



**J0440 Explorer or Shepherd's Hook**



**J0440a Sickle shaped scaler**



**J0440b Sickle shaped scaler, heavy**



**J0441 Dental probe, heavy tip.** Calibrated probe is used to measure depth of periodontal pockets. (not pictured)



**J0441a Dental probe tip, fine.** Finer calibrated tip for pulp horns and tooth surface pockets on the occlusal surface of cheek teeth



**J0441b Periodontal forceps, 41cm (16.4").** Heavy-duty right angle forceps is useful for removing forage or debris from periodontal pockets

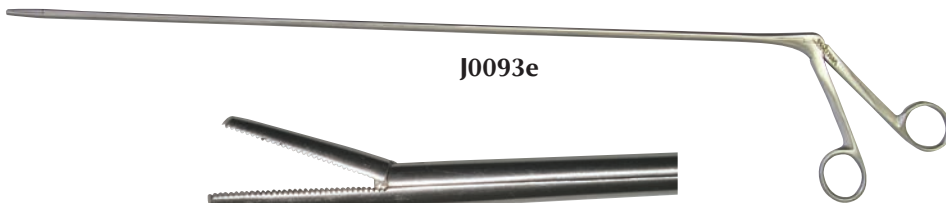

**J0093e Extra Long Alligator forceps with 18" shaft.** This is a useful instrument for grasping small fragments or placing cotton balls to help visualize the deep area of the oral cavity.

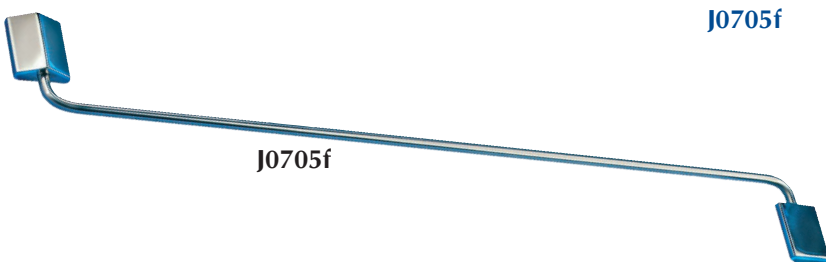

**J0705f Equine Dental Fulcrum.** Use as a fulcrum to gain leverage in conjunction with a molar extraction forceps when extracting large cheek teeth. Dual end. 22" (54cm) L.



**J0032h** **Hauptner Hoof Knife.** For the veterinarian who wants the very best. Small curl, ebony handle, right or left curve. Blade  $\frac{3}{8}$ " W x  $2\frac{1}{2}$ "L.

**J0032hL** **Hoof Knife.** Left hand.

**J0032hr** **Hoof Knife.** Right hand.



**J0032h Series**

**J0032hwr** **Right Curve Hoof Knife** with brown wooden handle. Blade  $\frac{5}{8}$ " W x  $2\frac{3}{4}$ "L.

**J0032hwL** **Left Curve Hoof Knife** with brown wooden handle. Blade  $\frac{5}{8}$ " W x  $2\frac{3}{4}$ "L.



**J0032hw Series**

**J0032e** **Swiss Hoof Knife.**



**J0032e**

**J0032f** **Folding Hoof Knife** combined with hoof pick. Handy pocket size.



**J0032f**

**J0034ad** **Aesculap Double Edge Hoof Knife** (Not Pictured)

**J0034cvl** **Aesculap Hoof Knife – Left** (Not Pictured)

**J0034cvr** **Aesculap Hoof Knife – Right** (Not Pictured)

**J0032p** **Hoof Pick.**



**J0032p**

**J0033h** **Hauptner Hoof Knife Hone.** Especially developed for hoof knives and will sharpen inside of curl.



**J0033h**

**J0032hse** **Economy Hoof Knife Set.**



**J0032hse**

**J0034** **Hoof Knife** with small curl, double edge. Blade  $\frac{5}{8}$ "W x  $2\frac{3}{4}$ "L.



J0034

**J0034c** **Hoof Knife.** High quality Swiss-made instrument with small curl, right- or left-curve. Blade  $\frac{5}{8}$ "W x  $2\frac{1}{2}$ "L.



J0034c

**J0034cL** **Hoof Knife.** Left hand.  
**J0034cr** **Hoof Knife.** Right hand.

**J0034cn** **Hoof Knife.** Same as J-34c only featuring narrow  $\frac{3}{8}$ " blade, right- or left-curved.  $2\frac{1}{2}$ "L.



J0034cn

**J0034cnL** **Hoof Knife.** Left hand.  
**J0034cnR** **Hoof Knife.** Right hand.

**J0034o** **Oval Hoof Knife.**



J0034o

**J0034s** **Hoof Searcher.** Blade  $2\frac{1}{2}$ "L.



J0034s

**J0131m** **Foot-Rot Hoof Shear.** Heavy handles as illustrated, with strong spring and safety clip. Specially designed tempered steel serrated blades.



J0131m

**J0032hg** **Hugh's Angled Hoof Groover.** This hoof groover has an elliptical doughnut-shaped working end. Elliptical opening is 2cm x 1cm. The bottom portion is sharpened. It is great for digging out or curetting hoof abscesses. Stainless steel handles.  $6\frac{1}{4}$ " (16cm) L.



J0032hg

**J0032hgs** **Hugh's Straight Cutting Head Hoof Groover.**



J0032hgs

**J0034L** **Small Loop Hoof Abscess Knife.** Designed to curette out the smallest of abscess with this very sharp, but small loop. Ergonomic shaped wood handle.



J0034L



J0061

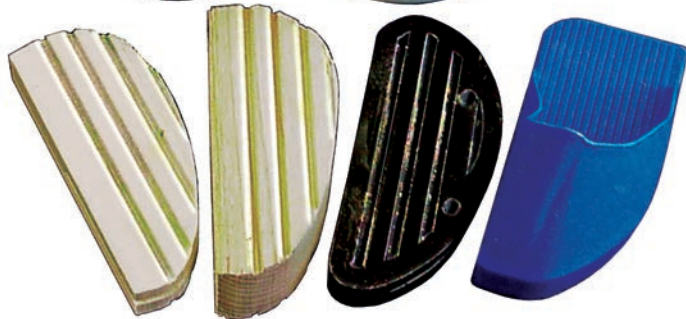

J0061b



J0061bh



J0061bx



J0061sL

**IMPROVED!**



J0061sr

**Technovit.** This popular acrylic consists of a powder and liquid that, when mixed together, form a strong binding adhesive material. The liquid and powder are mixed together in a roughly 1:2 ratio. Until it hardens, it can be poured and shaped. After it hardens, it can be sawed, drilled, or filed. It has a number of suggested uses.

- Cattle: a block or boot is adhered to the bottom of the healthy or unaffected claw, for sole abscesses or foot rot.
- Horses: quarter cracks, any hoof defects.
- Small animals: replace the connecting rod and K-E clamps for external fixation devices.

**Technovit Liquid.**

**J0061La Liquid.** 240cc.  
**J0061Lb Liquid.** 480cc.

**Technovit Powder.**

**J0061pa Powder.** 500g.  
**J0061pb Powder.** 1000g.

- No wait time between mixing and application.
- 20% pre-dissolved powder allows RAPID-VIT™ to be applied to the hoof immediately.
- RAPID-VIT™ can be shaped or formed and will not stick to WET hands.

**J0061Lat** 240cc

**J0061Lbt** 480cc

**J0061pa Powder** 500g

**J0061pb Powder** 1000g

**Hoof Block.** The use of hoof blocks is very popular in the treatment of hoof problems in cattle. JorVet offers three different types.

**J0061b Original Wood Block.** 1 1/2" thick.

**J0061bx Black Hard Plastic Block.** 3/4" thick.

**J0061bh Wood Block.** 3/4" thick.

**Technovit Kit.** Kit includes Technovit liquid, powder, and your choice of hoof blocks. Also included: mixing cups and wooden stirring sticks.

**J0061t6 6-Treatment Kit,** black plastic blocks, and accessories.

**J0061t12 12-Treatment Kit,** black plastic blocks, and accessories.

*NOTE: To substitute different hoof blocks, just add a letter to the above product codes:*

*W—standard wood blocks;  
 H—1" wood blocks; S—cow boots.*

**Cow Boot** slips on the healthy or unaffected claw. Stays on better than regular blocks. Inner sole is grooved for even more holding power. Blue. 3/4" thick.

- Can mix Technovit right in toe of the boot

**J0061sr Cow Boot.** Right claw.

**J0061sL Cow Boot.** Left claw.



**J0035b** **Hauptner Hoof Tester.** 14<sup>1</sup>/<sub>2</sub>".



J0035b

**J0035Lp** **JorVet Standard Hoof Tester.** Stainless steel. 13".



J0035Lp

**J0035f** **Adjustable Hoof Tester.** This sturdy model hoof tester has jaws of stainless steel and seven adjustments for every size hoof.



J0035f

**J0035p** **Large Hoof Tester.** Heavy-duty. Stainless steel. 13".

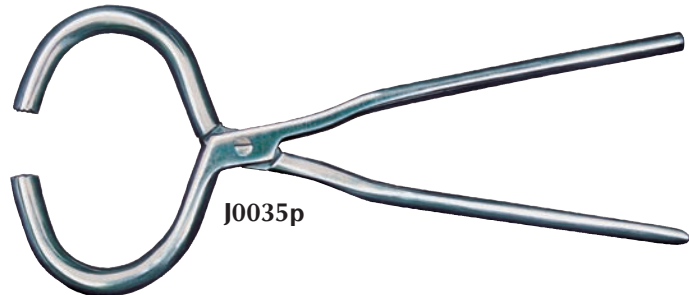

J0035p

**J0035xL** **Extra large hoof tester.** 21". Max jaw opening is 20cm (8") which is much larger than standard tester. Jaw teeth are large cleats for better hold. Stainless.



J0035xL

**J0035ec** **Ryding Hoof Tester.** New design allows for adjustable jaws over entire hoof surface. The jaws remain parallel for more even and steadier diagnostic pressure. The handle accommodates one-handed use, leaving the other hand free to hold the leg or for positioning the hoof. Stainless steel. Patented.



J0035ec





Every equine veterinarian should have the proper equipment when the necessity of “pulling” a shoe occurs during the course of a treatment. The following items are the common farrier tools for horseshoe removal.

**J1024** Hoof Crease Nail puller 12” (30cm) stainless. For the removal of nails especially when worn down inside the grooves of the shoe.



J1024

**J1024A** Shoe puller/spreader. 12” (30cm) stainless. To remove the shoes or also to adjust a shoe by spreading it for a better fit.



J1024a

**J1024B** Hoof nipper or trimmer (13<sup>1</sup>/<sub>2</sub>”) 34cm stainless for gentle trimming of the hoof.



J1024b

**J1024C** Clinch cutter. 6” double ended tool for opening the clinches to reduce hoof wall damage during shoe removal. Beveled on inside edge for closer cutting. Stainless. Other end is pointed for pritched.



J1024c

**J0035** **Steel Hoof Trimmer.** Popular compound action steel model, with extra sharp blades that are replaceable. Green with black handle grips. *Suggested for use with cattle.*



J0035

**J1319** **Farmhand Hoof Trimmer.** Lightweight Stainless Steel. **Equine use:** can be used with one hand by choking up on handles to narrow portion, cutting off small pieces of horn off the hoof. **Bovine use:** larger pieces can be cut by using two hands with outer ends of handles. Weight 1.1 kg (2.3 lbs). Length 36 cm (14.4”).



J1319

**Tubbease Hoof Sock.** Useful for poulticing hooves without stewing them as happens with regular sealed boots. Rubber dipped sock which breathes while still protecting and soaking the damaged hoof. This breathability prevents the hoof from going soft during treatment. A thick and flexible EVA pad was added to relieve pain for the horse and extend the life of the sock.

*Suggested Uses:*

- |              |                       |
|--------------|-----------------------|
| Hoof abscess | General deterioration |
| Thrush       | Cracks                |
| Seedy toe    | Injuries              |
| Thin sole    |                       |



Dimension is maximum width of hoof that will fit in the **Tubbease** cup.

**J1316** **Tubbease Hoof Sock** 14 cm (5.6”)

**J1316L** **Tubbease Hoof Sock** 16 cm (6.4”)



J1316

**Walkease™ and Tilt Tables.** One of the essential requirements for the successful use of the Walkease is that the cow's full weight is put on the hoof within one minute of application. This makes use of the Walkease unsuitable for tilt table crushes where it may take several minutes for the cow to be stood on her feet.

**NEW**



**Walkease®™ Early intervention hoof treatment.** Walkease has been created as an **early intervention** hoof claw prosthetic. It is not intended to replace other conventional hoof blocks on the market.

- Made from soft flexible EVA material that is soothing and comfortable for the cow to walk on
- Can be used on either claw
- Block should stay on for 7 – 21 days, which is generally long enough for recovery in mild cases



J1312

**J1312 Starter Kit**

- Handy carrying case: resealable
- 10 Walkease blocks
- Tube of special Walkease super glue
- Walkease hoof rasp
- 10 pairs of latex gloves

**J1312g Walkease Glue**, 20ml. This small bottle of glue is enough to apply 10 Walkease blocks

Detailed information and clinical studies at [www.JorVet.com](http://www.JorVet.com).

J1312g



**J1312b Walkease Blocks** only, 10pk. Large. Blue/white.



**J1312w Walkease Block Wedgies.** Our work with lame cows has shown us that elevating the heel more than the toe transfers the weight forward, relieving load on the more sensitive heel area. This leads to quicker hoof recovery. 10/pk.



J1312



**J1312r Walkease™ Hoof Rasp.** This hoof rasp uses the same blade and outting action as well known wood working rasps. Blade is 40mm x 60mm mounted in plastic handle. A very useful tool for repair work. Length 1cm (7.2").



J1312r

**J0038d** **Drinkwater Mouth Gag** for cattle. Holds onto inter-dental space. Self-retaining.

**J0038dr** **Mouth Gag.** Right.  
**J0038dL** **Mouth Gag.** Left.

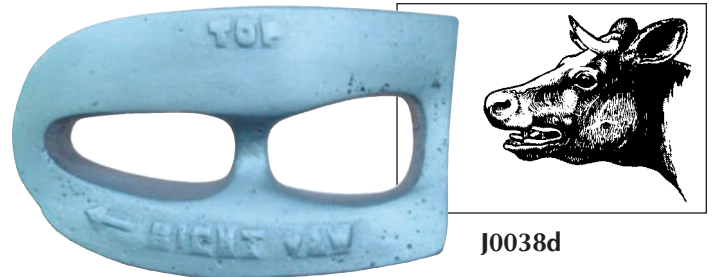

**J0038f** **Frick's Standard Oral Speculum.** Heavy-duty. Stainless steel. 19 1/2".



**J0201** **JorVet Bovine Hobble Strap.** These wide heavy-duty nylon straps are the perfect aid in giving support to cows showing the effects of obturator paralysis.



**J0044** **Equine Humane Twitch.** Kendall model. Complete with tie rope. Stainless steel. 13".

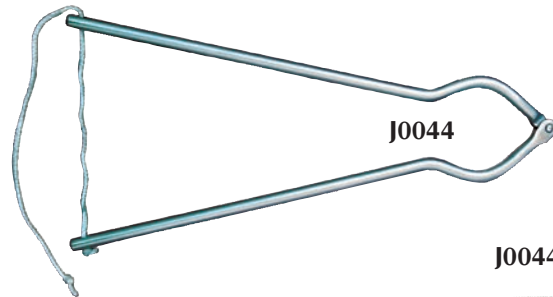

**J0044a** **Equine Chain Twitch.** Chain twitch with plated chain. 5" dia. loop with 25" flat wooden handle.



**J0044b** **Equine Nylon Twitch.** Twitch with heavy-duty nylon rope. 5" dia. loop with 25" flat handle. (not pictured)

**J0052p** **Polansky Vaginal Speculum** with 3 blades. Has butterfly screw with 2 blades on top for wide exposure. 26cm (10 1/2").

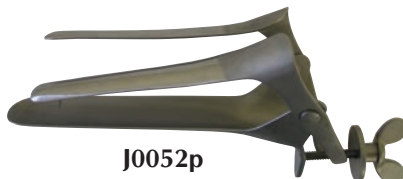

**J0052k** **Killian Vaginal Speculum** for dogs. Has set screw and 3 1/2" blades. Stainless steel.



**J0066** **Anti Kick Device.** Bron screw down model for use on Achilles Tendon. Bovine use.



**J0066b** **Anti Kick Bar.** Bovine use.







J0114t



J0045

J0045a

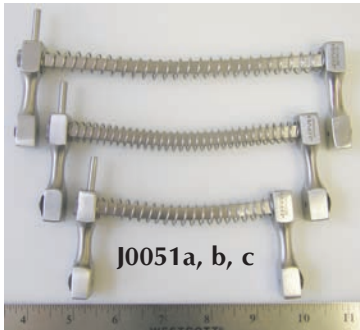

J0051a, b, c

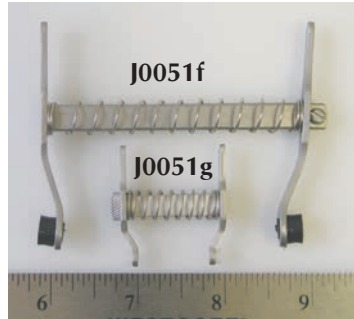

J0051f

J0051g



J0051g  
in use

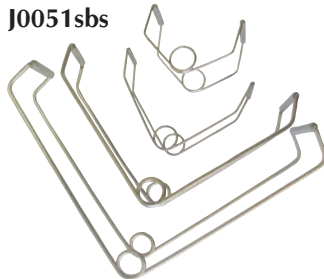

J0051sbs



J0051sbc

J0051sba

**J0114s JorVet Otoscope Cone.** Use cold sterilization only. For use with lightsource J0114bhm.



J0114s

**J0114t JorVet Tongue Depressor** for small animals. Excellent illumination for oral and laryngeal exams. Use with J-114bhm lightsource. Cold sterilization only.

**J0045 Gowland's Mayfield Veterinary Diagnostic Set.** Features:

- Medium battery handle.
- Uses two "C" (2.5v) batteries (not included)
- Otoscope head, 4x magnification
- Three veterinary long specula
- 80mm x 6mm
- 80mm x 4mm
- 58mm x 5mm
- One spare bulb
- One ophthalmoscope head
- Case

**J0045a Gowland's Otoscope** with veterinary length specula. Magnification is 4x. Uses two "C" batteries. (not included)

**Canine Mouth Gag.** Spring action with nylon inserts for less trauma. Three sizes available.

**J0051a Gag.** Small. Stainless steel. 4<sup>1</sup>/<sub>2</sub>".

**J0051b Gag.** Medium. Stainless steel. 5<sup>3</sup>/<sub>4</sub>".

**J0051c Gag.** Large. Stainless steel. 6<sup>3</sup>/<sub>4</sub>".

**J0051d1** Canine replacement insert.

**J0051f Feline Mouth Gag.** Small and lightweight. Stainless steel. 3".

**J0051fd** Feline replacement insert.

**J0051g Nazy Ferret gag.** A smaller version of the feline gag. This works very well on ferrets, kittens, and small puppies. 1<sup>1</sup>/<sub>8</sub>"

**J0051h Nazy Ferret/Feline Gag, large.** This new size is positioned between the very small ferret gag at 1" and the standard feline gag at 3". Suited for many of the smaller patients bigger than a ferret and smaller than an adult feline.

**Smith-Baxter Mouth Gag.**

**J0051sba Gag.** For small dogs. Stainless steel.

**J0051sbb Gag.** For medium dogs. Stainless steel.

**J0051sbc Gag.** For large dogs. Stainless steel.

**J0051sbd Gag.** For X-Large dogs. Stainless steel.

**J0051sbs Gags.** Set of all sizes.





**J0203** Pole: 38 1/2" L. Bag 36"L x 24"W.  
**J0203L** Bag 42"L x 38"W.

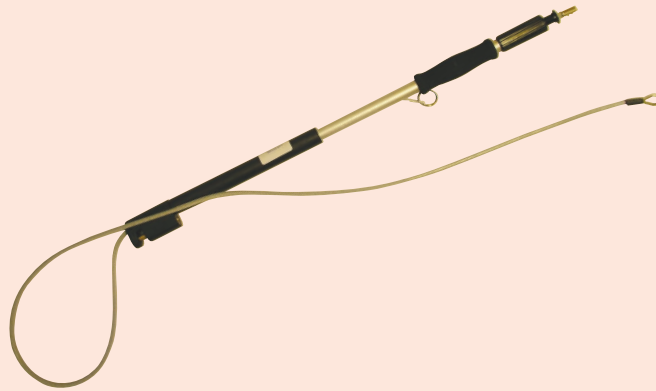

**J0140 series**

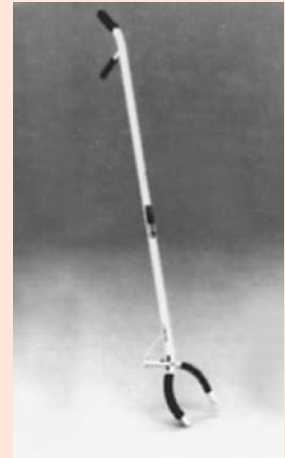

**J0141a**

**Welbourn Cat Catcher.** The Welbourn cat catcher is designed to aid the veterinarian in safe and easy handling of even the most unruly animals. The Welbourn cat catcher is constructed of tough nylon webbing and can be opened or closed quickly as needed.

- J0203 Welbourn Cat Catcher.**
- J0203L Cat Catcher** with larger bag and longer pole (54").

**Quick Release Dog Pole.** MDC dog poles have been designed to meet the animal control needs of veterinarians. The durable yet lightweight aluminum handle is available in 3 lengths and features a quick-release mechanism.

- J0140b Dog Pole.** 39".
- J0140c Dog Pole.** 70".

**Cat Grasper.** This lightweight grasper was designed primarily for the effective seizure and control of cats. It is ideal for reaching into the back of a cage to secure a difficult cat. The smoothly curved and finished jaws are plastic-covered and designed to minimize discomfort. If necessary, the animal can be quickly released. 30".

- J0141a Cat Grasper.**

**Ketch-All Pole.** This is the original "Rabies Stick" for restraint of vicious or hard to control animals. The metal pole has a locking mechanism to hold the cable tight plus a quick release button. Rubber cushion grips for two-handed no slip control. The end of the shaft has a covered portion to protect against chewing.

- J0915 Ketch-All Pole.** 3'. Suitable for cats and small dogs. 1 3/4 lbs.
- J0915a Ketch-All Pole.** 4'. The most popular for general use. 2 lbs.
- J0915b Ketch-All Pole.** 4-6'. Telescopes from 4-6' when additional length is needed. 2 1/2 lbs.

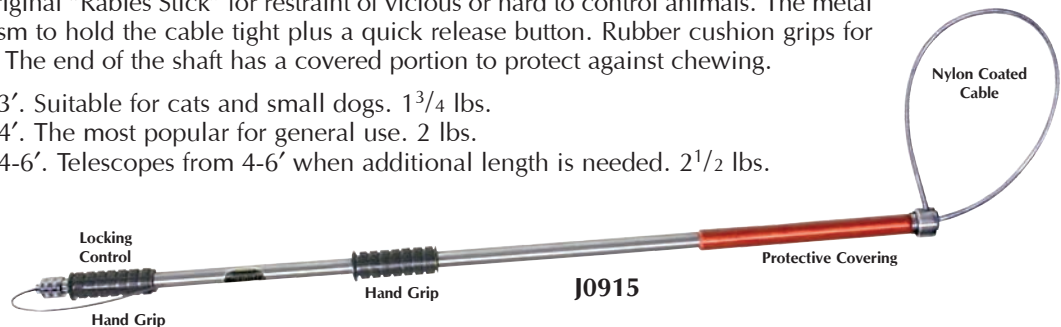

**J0142 Animal Restrainer.** The MDC Animal Restrainer is suitable for cats or any small animal, and is an effective means for limiting movement in order to administer an injection or effect treatment. 11 1/2"W x 17 1/2"L x 11"D.

**J0142t Trap Transfer Restrainer** has the added benefit of a facility for transferring the patient from a trap without the need for physical handling. Opening: 10 1/2" x 8". Overall: 11 1/2"W x 17 1/2"L x 11"D.

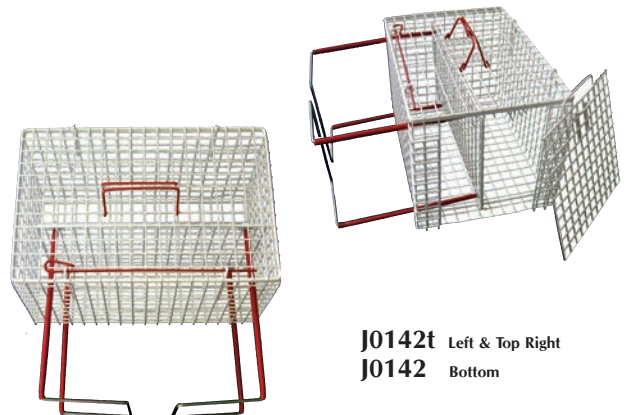

**J0142t** Left & Top Right  
**J0142** Bottom

**JorVet Halogen Penlight.** The JorVet Penlight with halogen bulb offers 400 percent more candle power than standard penlights. Uses two "AA" batteries, included.

**J0114bhm JorVet LED Penlight.**

**Attachments for the Halogen Penlight:**

**JorVet Large Animal Vaginoscope.** This speculum is autoclavable. Available in two sizes:

**J0114h Vaginoscope.** Equine and heifers. Autoclavable. 1 1/2" i.d. x 18".

**J0114i Vaginoscope.** Mares and cows. Autoclavable. 2" i.d. x 18".

**J0114km Light Conducting Rod with Clip.** Not autoclavable. (cliplight shown attached to scope)

**J0114j Bovine Heavy-Duty Laryngoscope.** Withstands chewing. Autoclavable. 1 1/2" x 18".

**JorVet Canine Gastroscope.** Excellent for visualizing the upper GI. Available in two sizes.

**J0114ns Gastroscope.** Small. Not autoclavable. 1/2" i.d. x 18".

**J0114nL Gastroscope.** Large. Not autoclavable. 5/8" i.d. x 18".

**JorVet Canine Vaginoscope.** Can also be used as a proctoscope. Three sizes:

**J0114os Vaginoscope.** Small. 1/2" i.d. x 6".

**J0114om Vaginoscope.** Medium. 5/8" i.d. x 8".

**J0114oL Vaginoscope.** Large. Can also be used on pigs, goats, and sheep. Not autoclavable. 3/4" i.d. x 8".

**J0114L Llama Vaginoscope.** 1" i.d. x 12".

**J0103 Foreign Body Retriever.** For small animals. This instrument can be inserted into gastroscope to grasp any lodged foreign body. 24".

**JorVet Dual Head Stethoscope.**

- Affordable stethoscope with great performance
- Dual head swivels for cardiac exams and breathing auscultation
- Wide range of fun colors
- 30" long tubing length

- J0205R Stethoscope.** Red tubing  
**J0205G Stethoscope.** Gray tubing  
**J0205BL Stethoscope.** Black Tubing  
**J0205PC Stethoscope.** Blue Tubing  
**J0205Y Stethoscope.** Yellow tubing

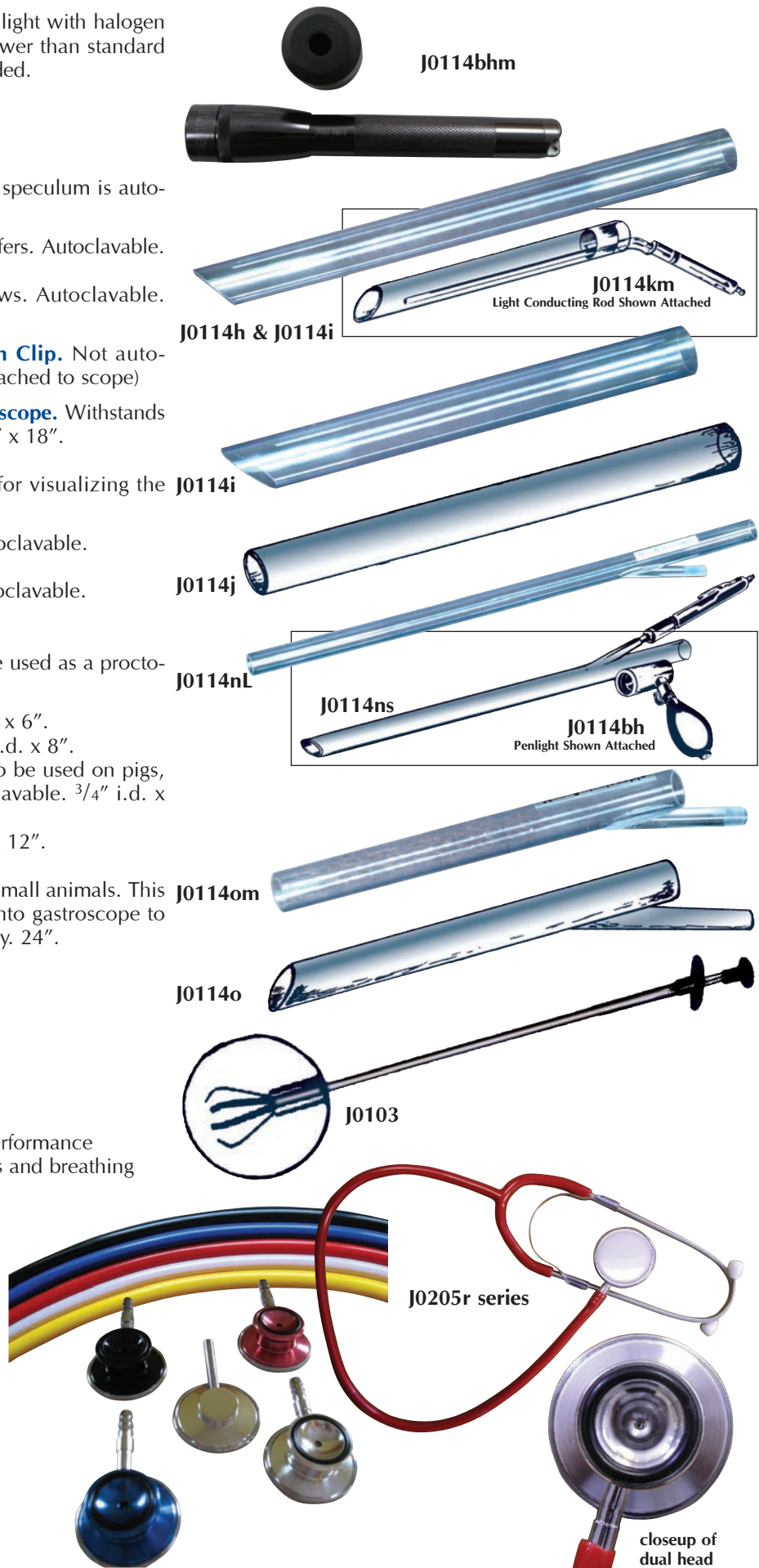



J0205u



J0205ut



**Custom Heads.** Additional designer heads, background colors, and engraving available upon request.



**Custom Tubing.** 29"L. Other colors available upon request. Latex free!

*TO ORDER: Select scope, head number and tubing color (i.e. 037 head with teal tubing would be J-205u 037-tealtubing).*

**The Ultrascopes are custom made to order, therefore they are non-returnable.**

**UltraScope Stethoscope** is enormously popular in the human medical field. The stethoscope head is pressure sensitive for assessment of heart and lung sounds. The scope will filter noises, such as barking dogs, while amplifying heart and lung sounds. Combines great acoustics with designer colors. Features cardiology style tubing. Total weight 4 oz.

The head design features an acoustic resonant amplifier with frequency range 20-35 kHz and solid acrylic one-piece design weighing 2 oz.



J0205uc

- J0205up** **Head, Pediatric.** 1<sup>1</sup>/<sub>4</sub>" diaphragm.
- J0205un** **Head, Neonatal.** 1<sup>1</sup>/<sub>2</sub>" diaphragm. Clear or color swirl.
- J0205ue** **Custom Engraving.**

- J0205ud** **Duo Stethoscope.** Two same or different size heads, one tubing.
- J0205ut** **Trio Stethoscope.** Three same or different size heads, one tubing.
- J0205uLa** **Large Animal Stethoscope.** Includes two extension tubes, maximum 50"L.
- J0205ute** **Teaching Stethoscope.** Includes two binaural tubings for both instructor and student.
- J0205uc** **Ultrascopes Classic Stethoscope.** Two binaural tubing, 1 head/2 stems for "experienced, mature users."

*NOTE: If diaphragm wears out due to normal wear, it will be replaced for free.*





# BUSTER



Made in Denmark  
Disposable Collars

**Buster Dog and Cat Collars.** Buster disposable protective collars for dogs and cats—an ideal and inexpensive solution.

**Material:** Made of lightweight flexible plastic. Will not annoy patient during rest since its flexibility will yield to the shape of the head. Endures pushing without getting deformed, even in cold weather.

**Application:** Easy to fit on the patient. The collar is closed without use of difficult tapes and strings. Its size can be adjusted according to the size of the patient's head, and fastened to the patient's collar by the straps.

**Sizes:** Available in 8 sizes with adjustments from 7cm to 20cm neck-hole. Each collar has 2 to 3 possible adjustments. Each collar has size marked on it. One size 10/pkg, or set of 8 sizes.

Catalog #	Size #	Length (cm)	Opening (cm)	Neck-Hole (cm)	
J0046a	7.5	7.5	7.5	13-15	7-8
J0046b	10	10	10	15-18	7-8
J0046g	12.5	12.5	12.5	18-20	10-12
J0046c	15	15	15	20-22	10-12
J0046d	20	20	20	22-24	12-14
J0046e	25	25	25	24-26	15-17
J0046f	30	30	30	26-28	17-20

J0046j **Buster Dog Collar.** 35cm  
J0046s **Buster Dog and Cat Collars.** Set of 7 sizes.

**Buster Classic Clear Collars.** The original Buster Collar only in a clear style for better visualization by patient. 10 per pack.

- J0046ac **Clear Classic Buster Collar.** 7.5cm
- J0046bc **Clear Classic Buster Collar.** 10cm
- J0046cc **Clear Classic Buster Collar.** 15cm
- J0046dc **Clear Classic Buster Collar.** 20cm
- J0046ec **Clear Classic Buster Collar.** 25cm
- J0046sfc **Clear Classic Buster Collar.** 30cm
- J0046gc **Clear Classic Buster Collar.** 12.5cm
- J0046sc **Set of 7 Clear Classic Buster Collars, one of each size**



J0046r **Stainless Steel Rack.** With pegs for all seven sizes. Offers a handy way to display the collars as well as store them.

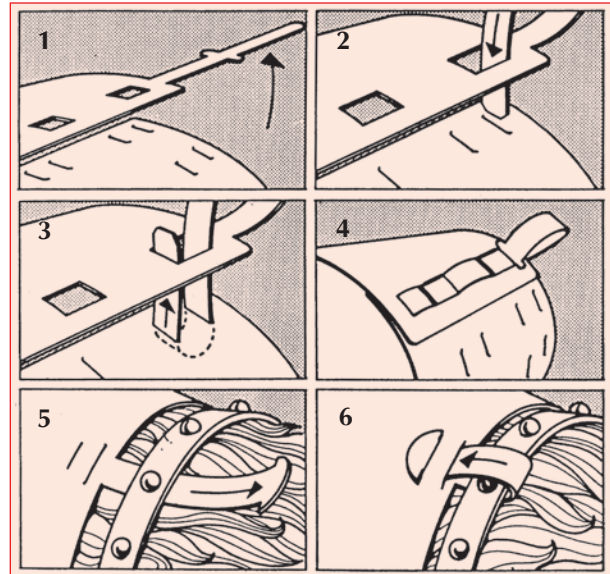

Buster Dog Collar Assembly, Above.  
Buster Bird Collar Assembly, Below.

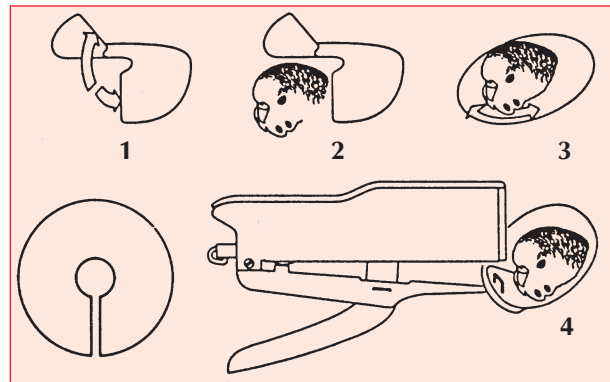

**Buster Bird Collar.** Clear plastic bird collars. Made of durable plastic material. Easy to assemble and requires only a few staples to secure in place.

- J0046bca **Plastic Bird Collar.** 8cm. 10/pkg.
- J0046bcb **Plastic Bird Collar.** 10cm. 10/pkg.
- J0046bcc **Plastic Bird Collar.** 14cm. 10/pkg.
- J0046bcd **Plastic Bird Collar.** 20cm. 10/pkg.
- J0046bcs **Plastic Bird Collars.** Set of 4.



J0046r Rack



**Clearcollar™ Elizabethan Restraint Collars** for cats and dogs. These collars have two major features not found in similar products currently available to veterinarians:

- The transparency feature is a substantial advantage for the patient in that it allows peripheral vision. Owners also seem to prefer transparent rather than opaque collars because they are far less conspicuous and appear to be more “humane.”
- The second major feature is a set of small plastic clips designed to make it quick and easy to apply and remove the collar repeatedly.

The collar also has three sets of loops for a more secure attachment either by weaving gauze or heavy cord through the loops and tying the ends in a bow, or by tying the loops to the pet’s collar.

Clearcollar™ restraint collars are available in six sizes, and each collar has five sets of adjustment holes to permit proper fitting of most patients. 10/box.



J0500 series

- J0500a **Restraint Collar.** 12".
- J0500b **Restraint Collar.** 15".
- J0500c **Restraint Collar.** 18".
- J0500d **Restraint Collar.** 24".
- J0500e **Restraint Collar.** 30".
- J0500f **Restraint Collar.** 38".
- J0500s **Restraint Collars.** Set of 6.

**J0047rc **Buster Rabbit Collar.**** Great protective collar for rabbits, guinea pigs, small toy breeds, and kittens. Transparent and easy to apply collar for rabbits. Adjustable size. 10/pk.

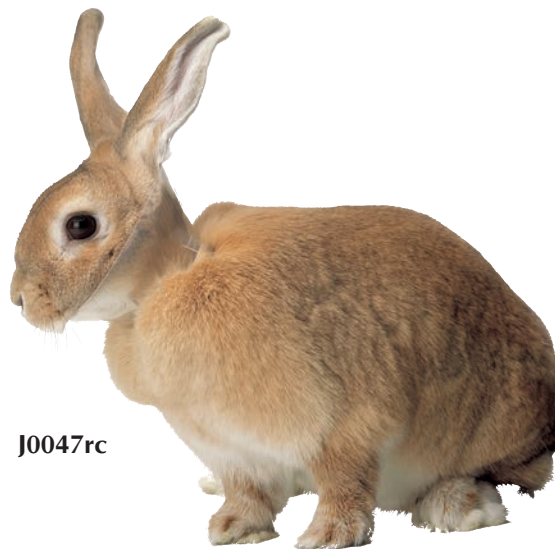

J0047rc

**Buster Clic Collar.** New quick and simple “clic” closing system. Makes the application of the collar as easy as buttoning your shirt.

Fully transparent material, environmentally friendly 100 percent polypropylene. The newly developed material allows the animal all-around vision and animals can avoid walking into furniture, etc.

Soft and flexible. Easy to apply to patient.

Available in 8 sizes plus combo pack. 10/box.

- J0047a **Clic Collar.** 7.5cm.
- J0047b **Clic Collar.** 10.0cm.
- J0047g **Clic Collar.** 12.5cm.
- J0047c **Clic Collar.** 15.0cm.
- J0047d **Clic Collar.** 20.0cm.
- J0047e **Clic Collar.** 25.0cm.
- J0047f **Clic Collar.** 30.0cm.
- J0047h **Clic Collar.** 40.0cm.
- J0047j **Buster Click Collar.** 35cm
- J0047s **Clic Collars.** Combo pack (7 smallest sizes). (35cm and 40cm collar not included)



J0047 series

*NOTE: Sizing differences.*  
*Buster collars: Sized in centimeters, referring to radius.*  
*Clearcollars: Sized in inches, referring to diameter.*  
**Sizes from one collar to another do not match.**



**BUSTER Comfort Collar with Soft Rubber Outer Edge.** Our range of BUSTER collars has been extended with the new BUSTER Comfort Collar. This new design of BUSTER collar is soft and flexible and it also features a soft rubber outer edge for better comfort, both for the animal and his surroundings.

The BUSTER Comfort Collar is transparent and has the quick-fastening system which is well-known from the BUSTER Clic Collar. Environmentally friendly material, 100% polypropylene. 5pk

J0047ac	7.5cm	J0047dc	20cm
J0047bc	10cm	J0047ec	25cm
J0047gc	12.5cm	J0047fc	30cm
J0047cc	15cm	J0047sc	set of all 7

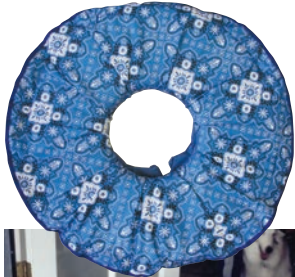

**Soft-E-Collar™.** The use of Elizabethan Collars is widespread in veterinary medicine. There have been a multitude of different designs over the years. Traditional “E” collars have tried to balance the comfort of the patient versus the effectiveness of the “E” collar. The Soft-E-Collar™ was designed first and foremost for the comfort of the patient, yet it still is effective in offering licking and chewing protection. Clients like the attractive pattern along with the comfortable foam padding. Pets can move about freely without damaging furniture, and are able to eat and drink more freely than with traditional collars.

The Soft-E-Collar™ is a waterproof heavy nylon material that covers a soft foam doughnut-shaped ring. It is held in place by a strong, flat tie.

		Weight (oz)	Diameter (inches)	Center (Adjustable) (inches)	
J1003a	XX-small	2.1	8	1 <sup>7</sup> / <sub>8</sub>	cat/dog up to 5 lbs
J1003b	X-small	2.6	9 <sup>1</sup> / <sub>4</sub>	2 <sup>3</sup> / <sub>4</sub>	cat/dog 5-9 lbs
J1003c	Small	3.2	10 <sup>3</sup> / <sub>4</sub>	4	cat/dog 10-14 lbs
J1003d	SS/Medium	5.7	14	4 <sup>1</sup> / <sub>2</sub>	cat/dog 15-20 lbs
J1003e	Small/Medium	7.0	16 <sup>1</sup> / <sub>2</sub>	5	dog 20-30 lbs
J1003f	Medium	11.3	19	6	dog 30-55 lbs
J1003g	Large	14.0	23 <sup>1</sup> / <sub>2</sub>	7 <sup>3</sup> / <sub>4</sub>	dog 55-75 lbs
J1003h	X-large	19.0	27 <sup>1</sup> / <sub>2</sub>	7 <sup>1</sup> / <sub>4</sub>	dog 75-95 lbs
J1003j	XX-large	22.0	31 <sup>1</sup> / <sub>2</sub>	7 <sup>1</sup> / <sub>4</sub>	dog over 95 lbs
J1003s	Set of all 9 sizes				

**Jorgensen Flexy Collar**



**Flexy Collar.** Soft flexible E collar made of nonwoven water resistant material. Lightly padded for comfort and better protection. Shoelace drawstring works especially well on cats. Priced considerably less than similar E collars. Two-tone blue color. Packaged in 5-packs except for sets.

J1095A	x-small	4"	cat
J1095B	small	5 <sup>1</sup> / <sub>2</sub> "	small dogs
J1095C	medium	6 <sup>1</sup> / <sub>2</sub> "	small to med
J1095D	large	8"	medium
J1095E	x-large	9 <sup>1</sup> / <sub>2</sub> "	large dogs
J1095S	introductory set of all 5 sizes		





**Foam Collar.** A safe and comfortable support for the neck of dogs and cats. It will also restrict movement of the head, thereby protecting other parts of the body from self-inflicted trauma. The Foam Collar is made from an ultra-light, dense and rigid closed-cell foam. The collar is black, with both sides being an easily cleaned "skin".

Application of the Foam Collar is simple. It is wrapped around the neck and held in place with one or two pieces of standard adhesive tape. It has no sharp edges, and the ends can be trimmed to an exact custom fit.

Six different widths are available to accommodate most dogs and cats.

To size for proper fit, measure from just behind the ear to the top bony portion of the shoulder.

- J0610a**    **Foam Collar.** 3"W. 15"L.
- J0610b**    **Foam Collar.** 4"W. 18"L.
- J0610c**    **Foam Collar.** 5"W. 21"L.
- J0610d**    **Foam Collar.** 6"W. 24"L.
- J0610e**    **Foam Collar.** 7"W. 28"L.
- J0610f**    **Foam Collar.** 8"W. 32"L.
- J0610s**    **Foam Collars.** Set of 6.



**J1320**    **Leash EZ Holder Universal Leash holder.** This clever device will hold a wide range of leash and new retractable leash devices in the market place. Holds the K-9 patient safely in place. Mounts just about anywhere. Comes complete with mounting screws and expander.



Holding retractable leash



Standard loop end nylon leash



Wide loop and nylon leash



**Handy Tech-Pet Parking System.** The new "hands free" secure pet parking system secures a dog safely in one quick and simple move. It is useful for both clients and clinic staff. The system can be mounted just about anywhere. Useful near or at the reception desk, in exam or treatment rooms. Spiral shaped with no sharp hooks. Epoxy-coated stainless steel. Two mounting screws with anchors provided. 2<sup>3</sup>/<sub>4</sub>"W x 2<sup>1</sup>/<sub>2</sub>"H x 2<sup>1</sup>/<sub>2</sub>"D. 4/box.

- J0762r**    **Parking System.** Red.
- J0762b**    **Parking System.** Blue.
- J0762g**    **Parking System.** Gray.
- J0762y**    **Parking System.** Yellow.
- J0762**    **Parking System.** Set of 4 mixed colors.

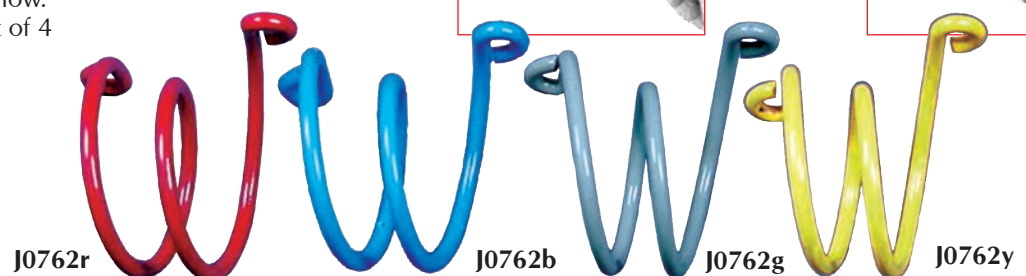
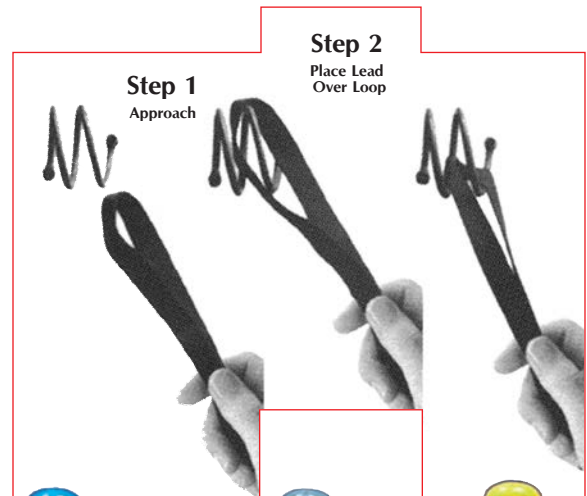
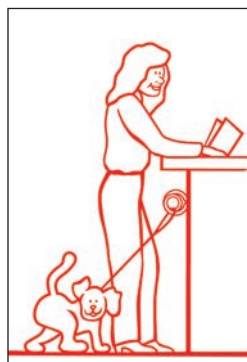





J0950



- J0950 Fecal Ova Float, Dispensing Box** with 50 Kits. 7<sup>1</sup>/<sub>2</sub>" x 5<sup>1</sup>/<sub>2</sub>" x 5".
- J0950b Fecal Ova Float.** 50 Kits/Bulk. (dispensing box not included)



J1069



**Fecal Specimen Container with Spoon.** A proper fecal exam is an essential part of any wellness program. However getting proper owner compliance is a challenge. The JorVet fecal specimen containers are an effective way to help assist the pet owner in getting a quality stool sample. Packaged 50 to a pack.

- Clear plastic vial-can readily see sample
- Snap on lid-easy for clients i.e. geriatric to close container
- Flat bottom-can stand right up
- Spoon attached to cap-can get stool sample with proper hygiene
- Patient stick-on label identifies proper client and patient
- Inexpensive-great for dispensing to client

**J1069 Fecal Specimen Container with Spoon.**

*Note: not designed for use as a floatation chamber*



J0147

J0147p

**Fecal Loop.** Inexpensive plastic loop with slotted ends for quick and easy fecal samples. Reusable.

A small, pencil-sized, flexible rod with a loop on each end. This can easily be inserted into the rectum and a small amount of fecal material trapped in the loop.

- Clean, disinfect, and use repeatedly
- Two convenient sizes available

**J0147 Standard Loop.** 3/8"W x 9"L.

**J0147p Puppy and Kitten Loop.** 1/4"W x 4<sup>3</sup>/<sub>4</sub>"L. A small investment that pays for itself the first time it is used.

**The Original Halti.** Dr. Roger Mugford developed the "Halti" over 27 years ago in the UK. His creative design was the first to address the idea of a head collar for dogs. His concept has been used by over 1 million canine owners worldwide.

Jorgensen Laboratories is now offering the Halti head collars for distribution to veterinarians. Today veterinarians and their staff are often involved in behavior modification and training. The Halti comes packaged in an attractive hanging display with written training instructions. These collars come in a variety of sizes. Color is black with red trim.

- J1011A** **Size 0 Halti** - Toy Poodle, Yorkie, Papillion & other toy breeds
- J1011B** **Size 1 Halti** - Jack Russell, Daschund, Westie, etc.
- J1011C** **Size 2 Halti** - Beagle, Cocker Spaniel, Schnauzer, etc.
- J1011D** **Size 3 Halti** - Boxer, Labs, Shepherds, Setters, etc.
- J1011E** **Size 4 Halti** - Rottweiler, Mastiff, Newfoundland
- J1011F** **Size 5 Halti** - St Bernard, Great Da Bloodhound
- J1011M** "Waldo" Our Canine Head Display Model
- J1011S** Introductory display kit. Includes 2 each of the 3 smaller size and 4 each of the 3 larger sizes, plus display head.

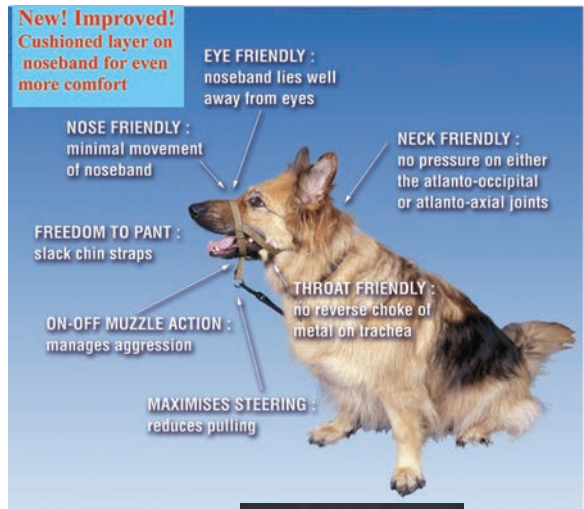

See [www.JorVet.com](http://www.JorVet.com) for suggested breed sizing



**The Halti Harness.** Designed by Dr. Roger Mugford, the Halti Harness has a unique patented front attachment system that controls the dog from his chest and shoulders; an effective point of control. The Halti Harness stops pulling, calms over-boisterous dogs and simplifies training and behavioral therapy. The benefit of a properly used Halti Harness is that it gives total control over the dog's shoulders and thus sets the direction in which he can move.

Best used in conjunction with the double ended Halti Training Lead, linked to both the chest and shoulder rings of the harness. The specially padded design is extremely comfortable for the dog to wear and is suitable for all breeds of dog. The new, patented Halti Harness is available in three sizes:

- J1012a** **Small**
- J1012b** **Medium**
- J1012c** **Large**

The Halti Harness comes with a free comprehensive training guide and represents excellent value for the money.



**Easy Fitting Guide**



**Adjustment**



**Attaching Lead**

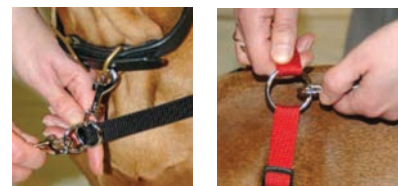



**Small Animal Protective Body Wear.** This new line of protective body wear has been used extensively by veterinarians throughout Europe. A wide range of applications has evolved literally from head to tail on a whole host of different species.

Traditional methods of wound protection such as “E” collars, and adhesive tapes have several known disadvantages. The VetMedCare protective body wear offers a great alternative to wound protection. Body suits are easy to handle and protect sensitive areas from dirt, scratching and licking.

Thoughtful design provides front and back leg openings that have special flat and stretch seams which help avoid limb irritations or abrasions. The belly is fully smooth, as the seam is along the back. Anatomical differences require consideration of both male and female designs.



**Material and Sizes:**

- Very Elastic, stretches in all directions for a comfortable fit
  - Wash and wear material: easy to clean, just hang to dry
  - Can be trimmed to custom size or shape and not fray or run
  - Wide range off sizes (6) to fit all small animals
  - Green/blue color is neutral surgery color
- Some applications:
- Surgical sites
  - Chest drains
  - Aural hematomas
  - PEG tubes
  - Open wounds
  - Additional protection over bandaged wounds
  - Can actually hold telfa pads tightly in place through use of simple snaps
  - Provides cosmetic benefits over unsightly wounds/injuries
  - Clients love them and so do the patients!

**Leg and extremity protection:**

- The special elastic tube-shaped material can cover leg or head wounds
- They attach to the body suit by light-weight simple snaps
- Head protection: trim in eyes and ears and/or trim to length desired
- Cone shaped product is designed for rear leg

Unusual patients require imagination and the body suits can help. See the applications noted to the right.

Dog/Cat bodysuit			Neck	Chest	Distance between
Female		Male	circum.	girth	front/back legs
J1055a	XS	J1055am	6–8"	8–10"	9.5"
J1055b	S	J1055bm	8–10"	12–16"	15"
J1055c	M	J1055cm	10–14"	16–20"	18"
J1055d	L	J1055dm	14–18"	18–24"	19.75"
J1055e	XL	J1055em	18–22"	24–30"	23.5"
J1055f	XXL	J1055fm	22–24"	26–35"	26.5"

**Leg/Head Extremity protection**

**J1055G** **Set of 4 sizes** 3 straight/1 cone shaped, 18 snap fasteners

**Introductory Kit**

**J1055S** **All 6 sizes, both female and male bodysuits and all 4 sizes of leg/head extremities** 18 pieces, Snap connections.



Snap attaches leg to body



Pig with large hernia



Rare swan worn for three weeks to adhere wing to body



Sheep with severe fly strike at base of ear



Single leg with use of snaps



Head cover



Body suit and head cover



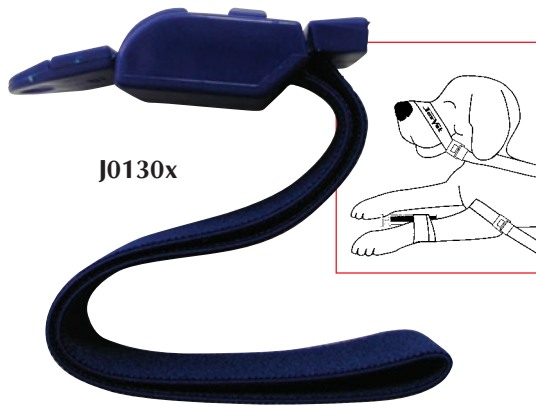

J0130x



J0130x buckle

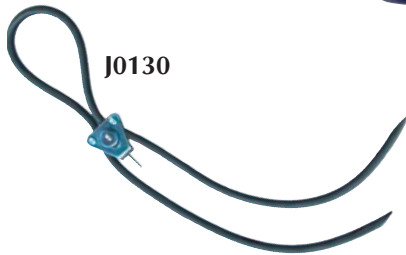

J0130

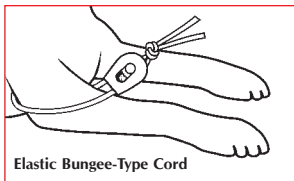

Elastic Bungee-Type Cord

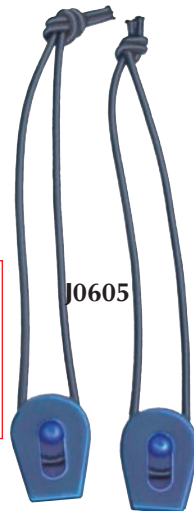

J0605

**J0130x JorVet Quick Release Tourniquet.** This new tourniquet has a quick release at the flick of a button. One hand can hold the syringe, the other can release the tourniquet. Broad blue band of stretch elastic gives a very tight fit. For dogs 40+ lbs.

**J0130 Nye Model Tourniquet.** Rubber, with automatic release; can also double as a canine muzzle. Metal clip.

**J0130r Spare Rubber for Nye Tourniquet.**

**J0605 Elastic Nylon Tourniquet.** This tourniquet looks so simple but it works! Nylon elastic bungee-type cord has a better stretch with a tighter fit. It is easier to tighten and release with one hand. Plastic clasp holds tough with no slipping. Inexpensive. Pr./Pkg.

**J0171q Surgical Tie-Downs.** Wide-braided  $\frac{3}{8}$ " polypropylene. Distributes tension over wide area. Royal blue color loop on one end. 4/Set.

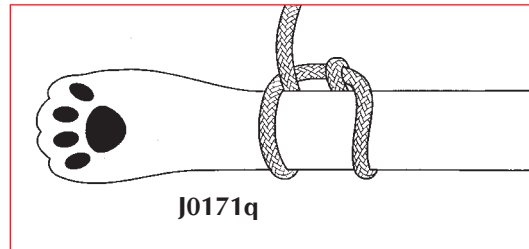

J0171q



J0171



J0345m

**All Purpose Apron.** This royal blue nylon cloth apron has an adjustable neck strap and a quick release buckle. Comfortable fit. Front dual pockets.

**J0171 Apron.** Small. 34" x 22".

**J0171a Apron.** Large. 38" x 24".

**J0345m White Plastic Disposable Aprons.** All purpose utility garment is water, oil, and chemical resistant. Useful for a lot of the "dirty" jobs around the clinic. Dispensing box of 100. 28" x 46" long.

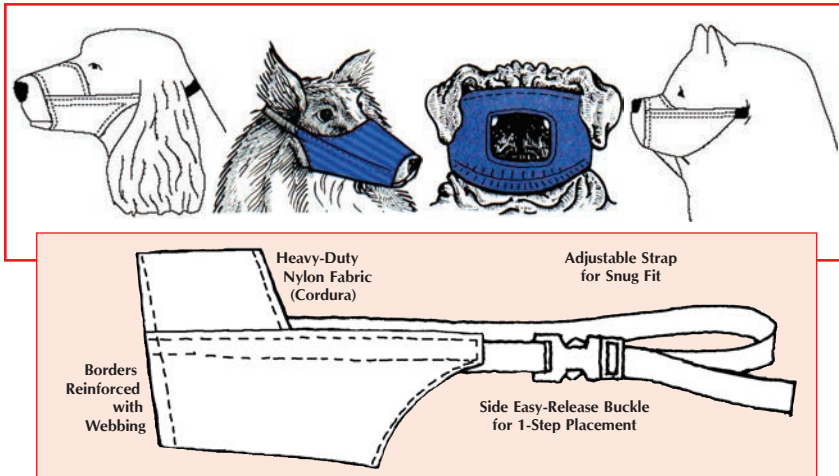

**Nylon Muzzle.** JorVet introduces an expanded line of high-quality water resistant nylon muzzles that have a side easy-release snap buckle. Comes in a variety of sizes. Features:

- **Safety.** Muzzles fit securely with adjusting straps for a snug fit.
- **Comfort.** Lightweight nylon feels and looks more professional than gauze roll.
- **Quality.** Reinforced stitching to assure long-lasting use.

**NOTE:** To best determine muzzle size, measure snout circumference.

Style	Animal Type	Snout Circumference	Approximate Weight	Color
<b>Standard:</b>				
J0169aa	Chihuahuas	3.5"	< 5 lbs.	Navy
J0169a	Toy Poodles	4.5"	5–10 lbs.	Silver
J0169b	Dachshund, Terrier	5.25"	10–25 lbs.	Red
J0169c	Cocker Spaniel	6.0"	25–40 lbs.	Royal Blue
J0169d	Bull Terrier	6.5"	40–70 lbs.	Gray
J0169e	Doberman	8.0"	70–100 lbs.	Black
J0169g	German Shepherd	10.0"	100–150 lbs.	Navy
J0169h	Labrador Retriever	11.0"	100–120 lbs.	Gray
J0169m	Great Dane	12.0"	120–150 lbs.	
J0169n	Giant Breeds	14.0"	150+ lbs.	
J0169s	Set of 7 Muzzles J-169a-g.			
J0169t	Canine 10-Muzzle Set. Consists of all 10 standard muzzles.			
J0169q	Canine 5-Muzzle Set. Consists of 5 middle sizes of standard muzzles.			
<b>Long, Narrow Snout:</b>				
J0169ks	Sheltie	4.5"	10–20 lbs.	Red
J0169km	Greyhound	5.5"	40–60 lbs.	Red
J0169kL	Collie, Shepherd	6.5"	80–120 lbs.	Red
J0169kt	Set of 3 Long, Narrow Snout Muzzles.			
<b>Chow/Rottweiler:</b>				
J0169js	Smaller Chow	7.5"	30–60 lbs.	Royal Blue
J0169jm	Chow	8.5"	60–90 lbs.	Royal Blue
J0169jL	Rottweiler	9.5"	120+ lbs.	Royal Blue
J0169jt	Set of 3 Chow/Rottweiler Muzzles.			
<b>Pug-Faced:</b> Muzzle uses a quick-closing velcro strap on the neck. Covers the eyes.				
J0169ps	Small Pug		5–12 lbs.	Green
J0169pL	Pug, Boxer		12–30 lbs.	Green
J0169pt	Set of 2 Pug-Faced Muzzles.			
<b>Feline:</b> Muzzle uses a quick-closing velcro strap on the neck. Covers the eyes.				
J0169fs	Small Cat		< 6 lbs.	Black/Green
J0169f	Medium Cat		6–12 lbs.	Burgundy
J0169fL	Large Cat		> 12 lbs.	Royal Blue
J0169ft	Set of 3 Feline Muzzles.			

**Leather Muzzle.** High quality, thick-grained leather with heavy-duty rivets. More reliable and safer than canvas or gauze muzzles. Five sizes available for Yorkshire Terriers to Great Danes. One size also especially designed for cats and brachycephalic breeds. (not pictured)

- J0230a **Muzzle.** X-Small.
- J0230b **Muzzle.** Small.
- J0230c **Muzzle.** Medium.
- J0230d **Muzzle.** Large.
- J0230e **Muzzle.** X-Large.
- J0230f **Muzzle.** Brachycephalic and Feline.
- J0230s **Muzzles.** Set of 6.

J0169x **Ferret Muzzle.** Anyone working

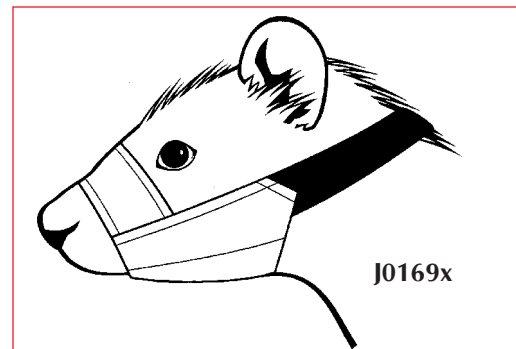

at all with ferrets will appreciate this muzzle.

**NOTE:** Colors may be subject to change.

**NEW**

**C-Muzzle®**

C-Muzzle with Velcro Flaps to Visualize Mouth and Teeth.

**Safety and Protection.** The use of a nylon muzzle is a common everyday necessity in a veterinary practice. Patients can be upset, frightened, and even vicious. However, standard nylon muzzles block access to the oral cavity. The **C-Muzzle** was developed by a practicing veterinarian to solve that problem. Velcro flaps on both sides of the jaw allow visual inspection and access to the patient's mouth.

- Assess parameters such as gum color and capillary refill
- Assess possible dental problems
- Give oral treatments such as emergency poisonings
- Oral vaccinations such as Bordetella

	Size	Recommended Breeds
<b>J1235</b>	0	Miniature Poodles, Miniature Dachshunds, Yorkies, Chihuahuas
<b>J1235a</b>	1	Standard Dachshunds, Jack Russells, Westies, Whippets
<b>J1235b</b>	2	Beagles, Border Collies, Cocker Spaniels, Springer Spaniels, Standard Poodles
<b>J1235c</b>	3	Bull Terriers, Dobermans, German Shepherds, Labradors
<b>J1235d</b>	3XL	Retrievers, Setters, Staffordshire Bull Terriers
<b>J1235e</b>	4	Breeds with wide, short snouts such as Boxers, Bloodhounds, Great Danes, St Bernards, Great Pyrenees
<b>J1235f</b>	4XL	Large Bloodhounds, Great Danes, Great Pyrenees
<b>J1235g</b>	5	Bull Mastiffs, Rottweilers
<b>J1235h</b>	5XL	Extra-Large Bull Mastiffs, Rottweilers
<b>J1235s</b>		Set of all nine sizes

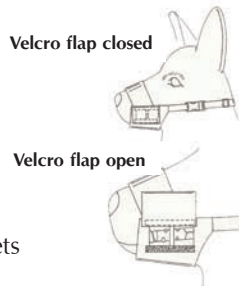

*Dr., your next patient is waiting for you.*



Anxious or fearful patient



Side flap open



Administer oral meds



J1235



**Caution: The use of any muzzle still has the risk of injury.**

C-Muzzle® Patent Pending

See [www.JorVet.com](http://www.JorVet.com) for more information on muzzle sizing

**NEW**

**Premium Cat Muzzle.** This dark plastic design fits comfortably and securely over the head of cats and small dogs, especially brachycephalic breeds.

- Tighten in place with draw string/lace and slide buckle
- 3 different sizes, differentiated by color of laces
- Easy to clean

<b>J1339a</b>	<b>Premium muzzle</b> —small cats and very small dogs
<b>J1339b</b>	<b>Premium muzzle</b> —standard size cat
<b>J1339c</b>	<b>Premium muzzle</b> —large cats and dogs >25lbs
<b>J1339s</b>	<b>Premium muzzle</b> —set of all three sizes





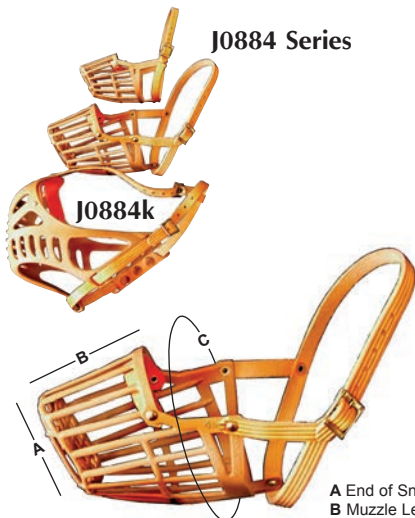

**Buster Nylon Plastic Basket Muzzle.** Constructed of strong nylon plastic with a reinforced nose and strong leather strap. Tan.

	Size	Breed	A	B	C
<b>J0884a</b>	2	Toy, Yorkshire Terrier, Papillon, etc.	2"	3.5"	8"
<b>J0884b</b>	3	Dachshund, Bichon Frise, etc.	2"	3.75"	8.75"
<b>J0884c</b>	4	Westie, Jack Russell, etc.	2"	3.75"	9.5"
<b>J0884d</b>	5	Corgi, Fox Terrier, Spaniel, etc.	2.25"	4.25"	10.5"
<b>J0884e</b>	6	Beagle, Border Collie, Cocker, etc.	2.25"	4.25"	12"
<b>J0884f</b>	7	Dalmation, Springer Spaniel, etc.	2.5"	4.5"	13"
<b>J0884g</b>	8	Labrador, Airdale, Chow Chow, etc.	2.75"	5"	13.5"
<b>J0884h</b>	9	German Shepherd, Weimaraner, etc.	3.25"	5.75"	14"
<b>J0884j</b>	10	Great Dane, New Foundland, etc.	3.25"	6.25"	15"
<b>J0884k</b>	13	Boxer			16"
<b>J0884s</b>	<b>Muzzle Set, all 10 Sizes.</b>				

A End of Snout Circumference  
B Muzzle Length  
C Circumference of Bridge of Nose

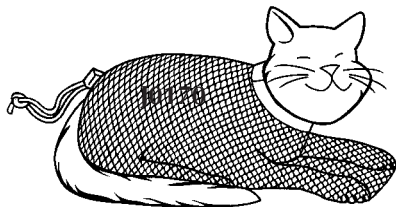

**Feline Restraint Bags.** These nylon bags are designed for proper restraint of fractious cats. They offer 2-way zipper running full length over back for either front or rear access. Comes equipped with a quick-close velcro collar and front leg openings. Pull-tab zipper flap provides quick, fur-free closure. Washable/waterproof. Colors may be subject to change.

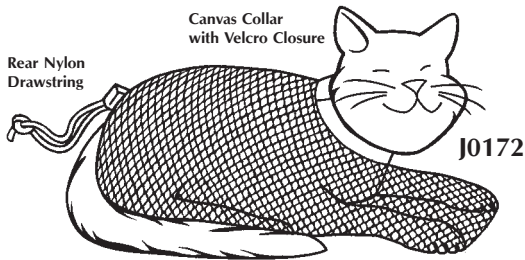

<b>J0170s</b>	<b>Cat Bag.</b> Small.	1-5 lbs.	Royal Blue
<b>J0170</b>	<b>Cat Bag.</b> Medium.	5-10 lbs.	Navy
<b>J0170L</b>	<b>Cat Bag.</b> Large.	10-15 lbs.	Royal Blue
<b>J0170m</b>	<b>Cat Bag.</b> X-Large.	15 - 25 lbs.	Royal Blue
<b>J0170n</b>	<b>Cat Bag.</b> XX-Large.	>25 lbs.	Royal Blue
<b>J0170t</b>	<b>Set of 3 Bags.</b> Small, medium, large.		
<b>J0170w</b>	<b>Set of 4 Bags.</b> Small, medium, large and X-large		
<b>J0170x</b>	<b>Set of 5 Bags.</b>		

**J0172** **Cat Restraint Bag.** White polyester mesh bag with rear nylon drawstring opening. The end has a canvas collar with velcro closure. Useful for general restraint in examination treatments or grooming. The bag will fit most cats.

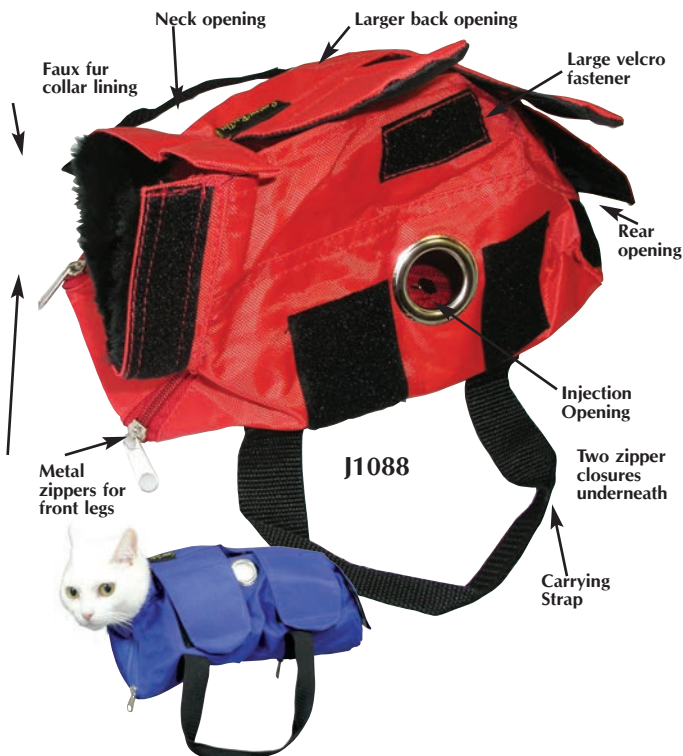

**Buster Deluxe Veterinary Restraint Bag.** The best product out there for restraint!! An improved version of our J-170 restraint series with these additional features:

- Two carrying nylon straps: ease of transport
- circular opening over back injection site
- Large velcro flaps over back and smaller for neck
- Faux fur-lined collar for patient comfort
- Four metal heavy-duty zippers: two for front legs and two on back underneath for rear legs
- Rear located velcro flap
- Heavier nylon material that is lined inside with water resistant material
- Color coded for size
- Hanging tab for easy access

	Size	Color	Weight
<b>J1088</b>	Small	Red	<2kg (4.4 lbs)
<b>J1088a</b>	Medium	Royal blue	2-4kg (4.4-9 lbs)
<b>J1088b</b>	Large	Green	4-6kg (9-13 lbs)
<b>J1088c</b>	X-Large	Light blue	6+kg (>13 lbs)
<b>J1088d</b>	Set of all four bags		

Handling of fractious or vicious animals is an occupational hazard in the veterinary environment. The main function of **Protective Gloves** can be divided into two areas: penetrating bites from mostly cats, small mammals or other exotics, and crushing injuries from mainly large dogs. Thus, both types of protection aren't necessarily needed at the same time. Penetration protection can be accomplished by using materials such as **Kevlar** (used in bullet proof vests) combined with resistant leather.

**CAUTION: NO GLOVES ARE BITE PROOF!**

*All JorVet animal protection gloves are made for specific purposes with known trade offs such as greater dexterity for decreased protection or reduced dexterity for increased protection.*

*Our commitment is to provide the best equipment but we cannot guarantee 100 percent protection in the wide variety of situations that can be encountered.*

**Cat and Wildlife Gloves.** Designed for maximum dexterity and feel (often missing in protective gloves). Provides a very high level of penetration protection through a combination of special materials. The hand features high quality top grain leather completely lined with new Spectra, which is ten times stronger than Kevlar. The gauntlet's double layer of Dupont **Kevlar** Knit resists sharp teeth, talons and claws, covering up past the elbow.

In addition to penetration resistance, the outstanding feature is you hardly know you have them on. Perfect for handling creatures that can not inflict crushing type bites. Excellent for cats, birds, and small animals. **These gloves are NOT bite proof. Please use with caution.**

**J0872 Small. J0872a Medium. J0872b Large.**

**Resistor Gloves.** Spectra lined for maximum penetration protection, yet has the dexterity of a driving glove. The gauntlet is extremely well padded and features "trauma plates" to protect against hard bites over a wide area. The back of the hand's shield protects against crushing bites but does not interfere with gripping.

Ideal for working with dogs, cats and exotics. The best all around glove. Attractive black leather.

**J0873 Small. J0873a Medium. J0873b Large.**

**JorVet Maxima.** Ideal for use against large dangerous dogs and other animals with crushing bites. Heavily padded throughout, but if not required, remove outer layer. Inner gloves features soft elk hide for dexterity plus padded gauntlet. This glove offers the maximum crushing protection.

**J0874 Small. J0874a Medium. J0874b Large.**

**JorVet Animal Gauntlets.** Penetration protection gloves, plus good dexterity. The gloves are heavy-duty elkhide plus extra-long suede gauntlets.

**J0791 Gauntlets. 18"L Small.**  
**J0791m Gauntlets. 23"L Large.**

**Leather Restraint Gloves.** Handling fractious animals can be made safer and easier with heavy-duty gloves. Light brown suede leather gloves have a padded lining for comfort and safety. Covers the forearm for real protection. One size fits all. 15 1/2"L.

**J0455 Leather Restraint Gloves. These gloves are NOT bite proof. Please use with caution.**



Kelvar Material Double Layered      Top Grain Leather Lined with Spectra      **J0872**



Thick Trauma Plates Spread Out Bite Force and Make It Difficult for Gripping Hold      Flap Protects Fingers  
 Spectra Lining      **J0873**      Designed for Dexterity

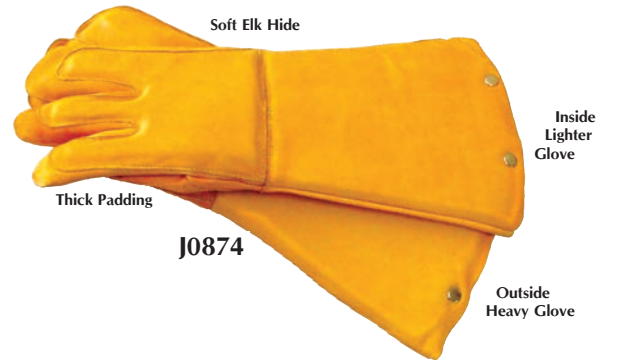

Soft Elk Hide      Thick Padding      **J0874**      Inside Lighter Glove      Outside Heavy Glove



**J0791 and J0791m**



**J0455**

**J0188 JorVet handheld digital thermometer.** The special design is a very ergonomic hand-held angle that works well for all animals large and small. Use two AAA batteries (included). You can select either Fahrenheit or Celsius. Automatically shuts off if not in use.

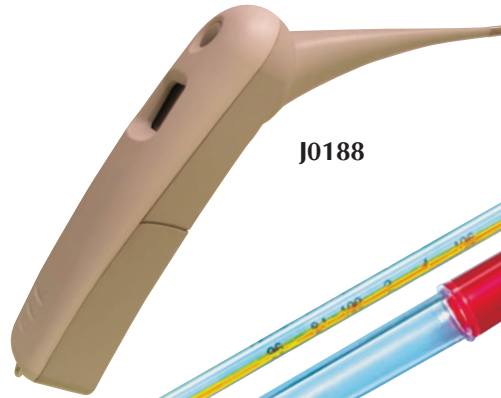

J0188

**J0460 JorVet Small Animal Thermometers.** Quality 4" stubby bulb rectal thermometer with a tri-top end, allowing non-slip insertion and removal, as well as not rolling off a flat surface. Complete with handy 2-piece plastic carrying case for safety and hygiene. Gold glass backing for quick and easy readouts. Full Fahrenheit scale of 96° to 106°. Guaranteed to comply with ASTM E667 specifications. 12/box. **Contains mercury. Please verify with your local authorities whether this product can be shipped to your location. Jorgensen Laboratories is not responsible for verifying this information.**

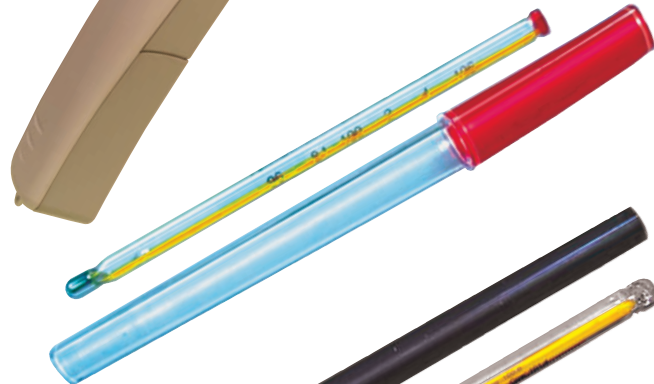

J0460

**JorVet Large Animal Thermometers.** Gold colored backing for quick and easy fahrenheit scale readouts. Heavy-duty with ring top. 5"L. **Contains mercury. Please verify with your local authorities whether this product can be shipped to your location. Jorgensen Laboratories is not responsible for verifying this information.**

Available with or without a case.

**J0187q Thermometer.** With case. 12/pk.  
**J0187r Thermometer.** Without case. 12/pk.  
**J0187qd Thermometer and Case** mounted on shrink-wrapped card.



J0187q

**J0187f Plastic Thermometer Case.** 5"L.

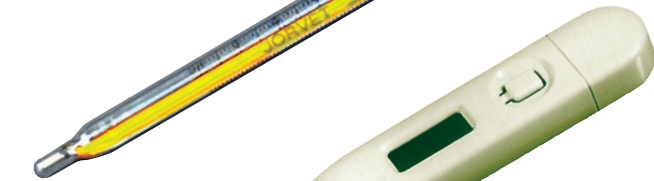

J0187r

**J0134a Audible Digital Thermometer (F°).**  
**J0134ac Probe Covers.** Sterile. 4"(10cm)L. 100/pk.



J0134a

*NOTE: Not recommended for use in large animals.*

**J0134f Digital Thermometer (F°) with Flexible Tip** is

*NOTE: Not recommended for use in large animals.*

a lot more patient-friendly than the standard rigid thermometer. Reads fahrenheit scale and has an audible beep when ready. Battery operated.



J0134f

**J0133 Kitty Kab Pet Carrier.** This sturdy corrugated carton is great for transporting patients to and from the clinic. This is a nice dispensing item for veterinarians and makes clinic visits more convenient for the client. Shipped flat for easy storage. 9"W x 11 1/2"H x 18"L when assembled. 20/carton.



J0133



**J0742 JorVet Animal Stretcher** offers more than any other conventional stretcher. Equipped with two wheels on one end and a carrying handle on the other, the stretcher enables one person to move a patient. It can also be used in the conventional two-person carry.

The frame is a lightweight coated steel. The stretcher is constructed of black, heavy-duty reinforced nylon. Three 2"W straps with buckles allows secure patient positioning. 24"W x 48"L. Holds up to 200 pounds.



J0742

Wheels



**J1298 Small Patient Transfer Board.** This thin flexible plastic sheet is useful for transporting small patients before and after surgery. High volume practices can clip and prep a patient, transfer to surgery, and return to recovery.

- 6 slots (1/2" x 3") for tie down ropes or handles
- Easy to store
- Dimensions: 22<sup>3</sup>/<sub>4</sub>"W x 31"L tapering to 17"
- Weight capacity: 30lbs

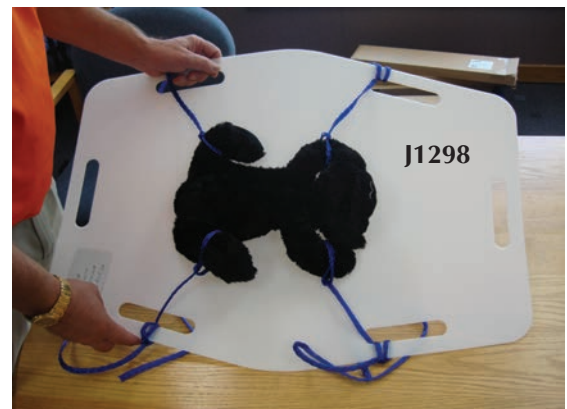

J1298

**JorVet Safety Stick Pole Syringes.** This syringe allows you to obtain a proper needle stick, then push the dosage plunger on the operator end. Syringe recommended: 3cc disposable Monoject. Constructed of aircraft aluminum alloy and stainless steel. Black anodized satin finish.

- Uses a standard Monoject 3cc syringe
- Mechanism cannot be damaged by even the most powerful animal bite
- Available in 3 different lengths
- Easy to inject through cage or from a safe distance.

- J0482a 3' Pole Syringe
- J0482b 4' Pole Syringe
- J0482c 6' Pole Syringe



J0482 series

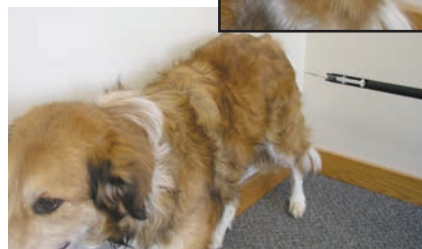

Jorgensen Laboratories offers two complete lines of **General Surgical Instruments**. JorVet, is our top quality line is from selected German manufacturers. Accent, is our quality line of economy-priced instruments. All instruments are made of stainless steel.

**Spay Neuter Pack.** Complete surgery pack for routine spay and general surgery. Features a mix of German-made and/or economy instruments.

- Olsen Hegar Needle Holder. Tungsten carbide tip. German-made. 6<sup>1</sup>/<sub>2</sub>"L (~16cm).
- Mayo Scissors. Straight. German-made. 5<sup>1</sup>/<sub>2</sub>"L (~14cm).
- Instrument Tray. 10" x 6<sup>3</sup>/<sub>4</sub>" x 2" (~25.4cm x 17cm x 5cm).
- Heavy-Duty Cloth Pack Wrap. 27" x 27" (~68.5cm x 68.5cm).
- Huck Towel. 17" x 33" (~43cm x 84cm).
- Brown Adson Forceps. German-made. 4<sup>3</sup>/<sub>4</sub>" (~12cm).
- Scalpel Handle. #3 economy.
- Sponge Forceps. Economy. 8" (~20cm).
- Four Backhaus Towel Clamps. Economy. 5<sup>1</sup>/<sub>2</sub>" (~14cm).
- Two Mosquito Forceps. Straight. Economy. 5" (~12.7cm).
- Two Kelly Forceps. Curved. Economy. 5<sup>1</sup>/<sub>2</sub>" (~14cm).
- Snook Spay Hook. Economy. 8" (~20cm).
- Allis Tissue Forceps. Economy. 6" (~15cm).
- Spring Suture Needle Holder. German-made.
- Two Carmalt Forceps. CVD. Economy.

**J0432 Spay Neuter Pack.**



**Halstead Mosquito Hemostat. 5".**

- J0070cw** German-Made. Curved.
- J0070sw** German-Made. Straight.
- J0070c** Economy. Curved.
- J0070s** Economy. Straight.



**Kelly Hemostat. 5<sup>1</sup>/<sub>2</sub>".**

- J0071cw** German-Made. Curved.
- J0071sw** German-Made. Straight.
- J0071c** Economy. Curved.
- J0071s** Economy. Straight.

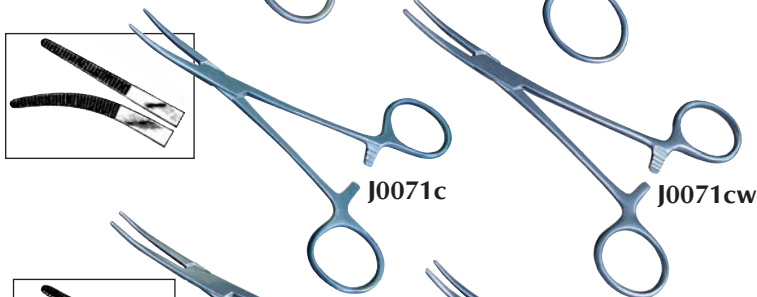

**Crile Hemostat. 6".**

- J0072cw** German-Made. Curved.
- J0072sw** German-Made. Straight.
- J0072c** Economy. Curved.
- J0072s** Economy. Straight.



**Fergusson Angiotribe.**

- J0073cw** German-Made. Curved. 6<sup>1</sup>/<sub>2</sub>" (16.5cm)
- J0073sw** German-Made. Straight. 6<sup>1</sup>/<sub>2</sub>" (16.5cm)
- J0073c** Economy. Curved. 7"
- J0073s** Economy. Straight. 7"

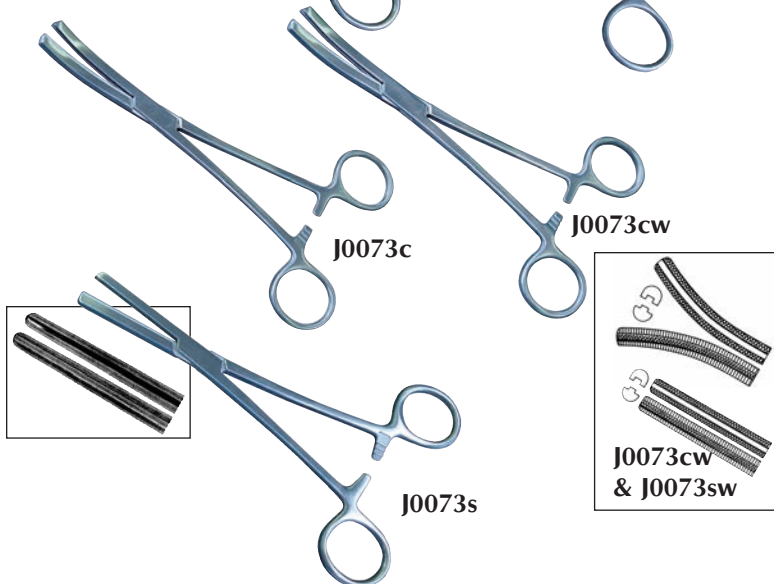

**Rochester Oschner.** 1 x 2 teeth at tip. 6 1/4" (16cm).

- J0072row** **German-Made.** Curved.
- J0072ro** **Economy.** Curved.
- J0072rsw** **German-Made.** Straight.
- J0072rs** **Economy.** Straight.

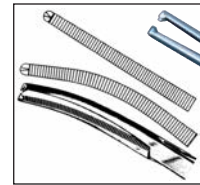

**Rochester Carmalt Forceps.** 6 1/4".

- J0083cw** **German-Made.** Curved.
- J0083sw** **German-Made.** Straight.
- J0083c** **Economy.** Curved.
- J0083s** **Economy.** Straight.



**J0135c** **Doyen Forceps.** Curved. Excellent for ear cropping. 4" jaws. Stainless steel. 9".



J0083cw

J0083c

J0083s

J0072r

**J0135s** **Doyen Forceps.** Straight. Stainless steel.

**Baby Doyen Intestinal Clamp.** 6 1/2" flexible blade with diagonal serrations.

- J0135cw** **Baby Clamp.** German-Made. Curved.
- J0135sw** **Baby Clamp.** German-Made. Straight.



J0135cw & J0135sw

**J0072dv** **DeBakey Vascular 10" Clamp.** Stainless steel. Slightly curved 7.5cm L jaw.

- J0074wa** **Lister Bandage Scissors.** German-Made. 5 1/2".
- J0074wb** **Lister Bandage Scissors.** German-Made. 7 1/2".
- J0074a** **Lister Bandage Scissors.** Economy. 5 1/2".
- J0074b** **Lister Bandage Scissors.** Economy. 7 1/2".

**J0074x** **Knowles Bandage Scissors.** Heavier scissors with straight blade. Also, useful for necropsy work during an intestinal examination. 14cm (5 1/2").

**J0075u** **Universal Scissors** can cut through almost anything. A multitude of uses around any clinic. Black. Autoclavable.

**J0075us** **Universal Lister Bandage Scissors.** Black. 5 1/2". Smaller than J-75u.

**J0074hb** **Heavy-Duty Bandage and Cast Cutter** with spring action. Stainless steel. 8 1/2".

Also available in:

- J0075UBL** **Blue handle.**
- J0075UR** **Red handle.**
- J0075UG** **Green Handle.**
- J0075UY** **Yellow handle.**





**J0076** **Littauer Stitch Scissors.** Economy. 5<sup>1</sup>/<sub>2</sub>".  
**J-76w** **German-Made.** 5<sup>1</sup>/<sub>2</sub>".

**J0076sw** **Spencer Stitch Scissors.** German-made. For fine sutures. 3<sup>1</sup>/<sub>2</sub>".

**Steven Tenotomy Scissors.** Real delicate scissors for doing more precise surgery (i.e., avian). 4<sup>1</sup>/<sub>4</sub>" (10.8cm).

**J0075ts** **Tenotomy Scissors.** Straight, sharp points.

**J0075tb** **Tenotomy Scissors.** Straight, blunt points.

**Alligator Forceps.**

**J0093a** **Forceps.** 3<sup>1</sup>/<sub>2</sub>" Shaft.

**J0093b** **Forceps.** 5<sup>1</sup>/<sub>2</sub>" Shaft.

**J0093bw** **Forceps.** German-made. 5<sup>1</sup>/<sub>2</sub>" Shaft.

**J0093c** **Forceps.** 8" Shaft.

**J0093d** **Forceps.** 12" Shaft.

**J0093e** **Forceps.** 18" Shaft.

**J0049x** **Martin Cartilage Scissors.** Heavier blades with one serrated edge. Useful for trimming ears. German-made. 8" (20cm).

**J0887** **Finger Ring Cutter.** Useful tool for removing leg bands from birds. 6<sup>1</sup>/<sub>2</sub>" (16cm).

**J0887d1** **Replacement Blade.**

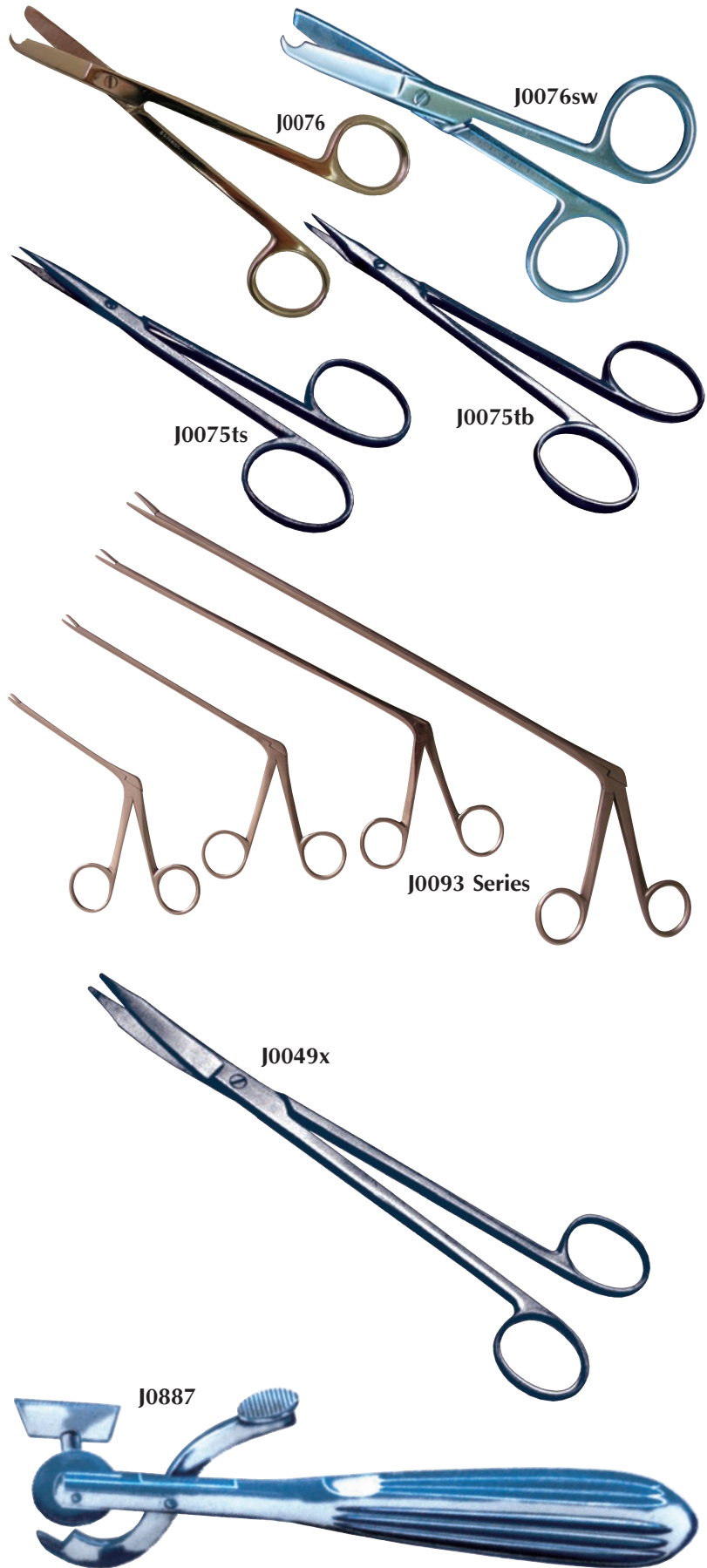

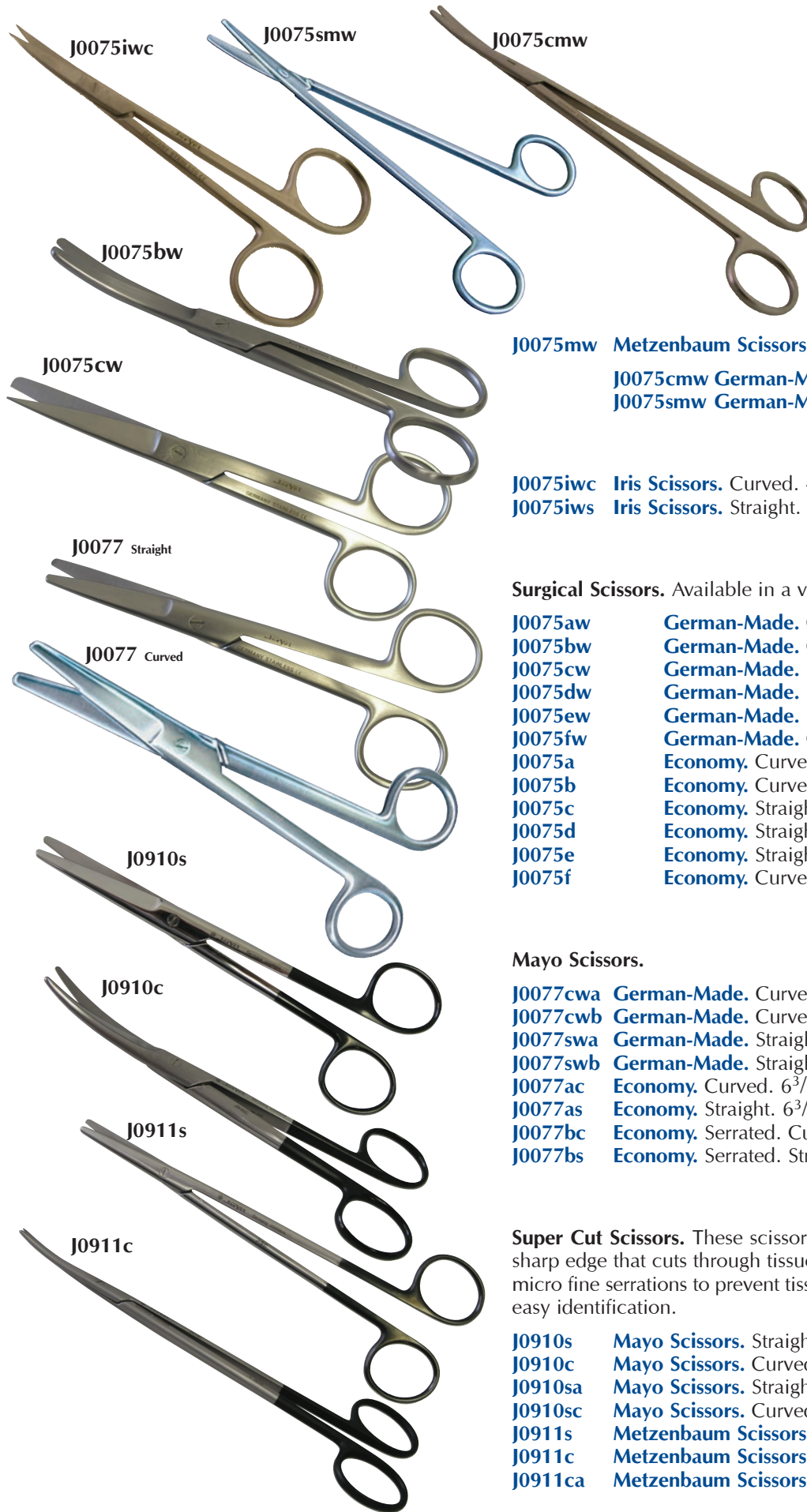

**J0075mw Metzenbaum Scissors.**

**J0075cmw German-Made.** Curved. 7".

**J0075smw German-Made.** Straight. 7".

**J0075iwc Iris Scissors.** Curved. 4 1/2".

**J0075iws Iris Scissors.** Straight. 4 1/2".

**Surgical Scissors.** Available in a variety of points:

<b>J0075aw</b>	<b>German-Made.</b> Curved.	S/B	5 1/2".
<b>J0075bw</b>	<b>German-Made.</b> Curved.	B/B	5 1/2".
<b>J0075cw</b>	<b>German-Made.</b> Straight.	S/B	5 1/2".
<b>J0075dw</b>	<b>German-Made.</b> Straight.	B/B	5 1/2".
<b>J0075ew</b>	<b>German-Made.</b> Straight.	S/S	5 1/2".
<b>J0075fw</b>	<b>German-Made.</b> Curved.	S/S	5 1/2".
<b>J0075a</b>	<b>Economy.</b> Curved.	S/B	5 1/2".
<b>J0075b</b>	<b>Economy.</b> Curved.	B/B	5 1/2".
<b>J0075c</b>	<b>Economy.</b> Straight.	S/B	5 1/2".
<b>J0075d</b>	<b>Economy.</b> Straight.	B/B	5 1/2".
<b>J0075e</b>	<b>Economy.</b> Straight.	S/S	5 1/2".
<b>J0075f</b>	<b>Economy.</b> Curved.	S/S	5 1/2".

**Mayo Scissors.**

<b>J0077cwa</b>	<b>German-Made.</b> Curved.	5 1/2".
<b>J0077cwb</b>	<b>German-Made.</b> Curved.	6 3/4".
<b>J0077swa</b>	<b>German-Made.</b> Straight.	5 1/2".
<b>J0077swb</b>	<b>German-Made.</b> Straight.	6 3/4".
<b>J0077ac</b>	<b>Economy.</b> Curved.	6 3/4".
<b>J0077as</b>	<b>Economy.</b> Straight.	6 3/4".
<b>J0077bc</b>	<b>Economy.</b> Serrated. Curved.	
<b>J0077bs</b>	<b>Economy.</b> Serrated. Straight.	

**Super Cut Scissors.** These scissors have a specially designed razor sharp edge that cuts through tissue like butter. The lower blade has micro fine serrations to prevent tissue slippage. Black finger rings for easy identification.

<b>J0910s</b>	<b>Mayo Scissors.</b> Straight.	6 3/4" (17cm).
<b>J0910c</b>	<b>Mayo Scissors.</b> Curved.	6 3/4" (17cm).
<b>J0910sa</b>	<b>Mayo Scissors.</b> Straight.	5 1/2" (14cm).
<b>J0910sc</b>	<b>Mayo Scissors.</b> Curved.	5 1/2" (14cm).
<b>J0911s</b>	<b>Metzenbaum Scissors.</b> Straight.	7" (18cm).
<b>J0911c</b>	<b>Metzenbaum Scissors.</b> Curved.	7" (18cm).
<b>J0911ca</b>	<b>Metzenbaum Scissors.</b> Curved.	5 3/4" (14cm).

**Needle Holders** featured in this catalog are made with special tungsten carbide jaws. Tungsten carbide will hold tight enough that even round-bodied needles don't twist or turn.

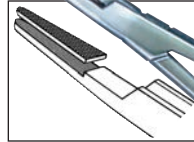

- Jaw edges are chamfered to prevent accidentally cutting suture
- Finger rings are well rounded and polished for better feel and prevention of finger fatigue
- Satin finish to reduce glare
- Gold plated finger rings for easy identification

**Mayo Hegar Needle Holder.**

- J0078wta** **German-Made.** Tungsten carbide jaws. 6".
- J0078wtb** **German-Made.** Tungsten carbide jaws. 7".
- J0078a** **Economy.** Stainless steel. 6".
- J0078b** **Economy.** Stainless steel. 7".

**J0078x** **Crile Wood Needle Holder.** Finer, narrower jaws than Mayo Hegar. Tungsten carbide jaws. 6" (15cm).

**Olsen Hegar Needle Holder.** Needle holder and scissors combination. (Not for use in Bovine surgery.)

- J0079wta** **German-Made.** Tungsten carbide jaws. 5 1/2".
- J0079wtb** **German-Made.** Tungsten carbide jaws. 6 1/2".
- J0079wdt** **German-Made.** Tungsten carbide jaws. 7 1/2".
- J0079a** **Economy.** 6".
- J0079b** **Economy.** 7".

**J0080** **Mathieu Needle Holder.** Just squeeze to release. Economy. 7".

**J0080wt** **German-Made.** Tungsten carbide jaws. 6 1/2".

**J0080wth** **Heavy-Duty Mathieu Needle Holder.** This extra-heavy needle holder with tungsten carbide jaws and gold handles will stand up to the demands of the large animal practitioner. 8".

**J0080aw** **Allis Tissue Forceps.** German-made. 6".

- J0080a** **Economy.** 6"
- J0080b** **Economy.** 7"

**Backhaus Towel Clamp.**

- J0081aw** **German-Made.** 3 1/2".
- J0081bw** **German-Made.** 5 1/2".
- J0081ws** **German-Made** with stops (Roeder). 5 1/2".
- J0081a** **Economy.** 3 1/2".
- J0081b** **Economy.** 5 1/2".
- J0081s** **Economy** with stops (Roeder). 5 1/2".

**J0085** **Sponge Forceps.** 9 1/2".

**J0082** **Jones Towel Clamp.** Economy. 3 1/2".

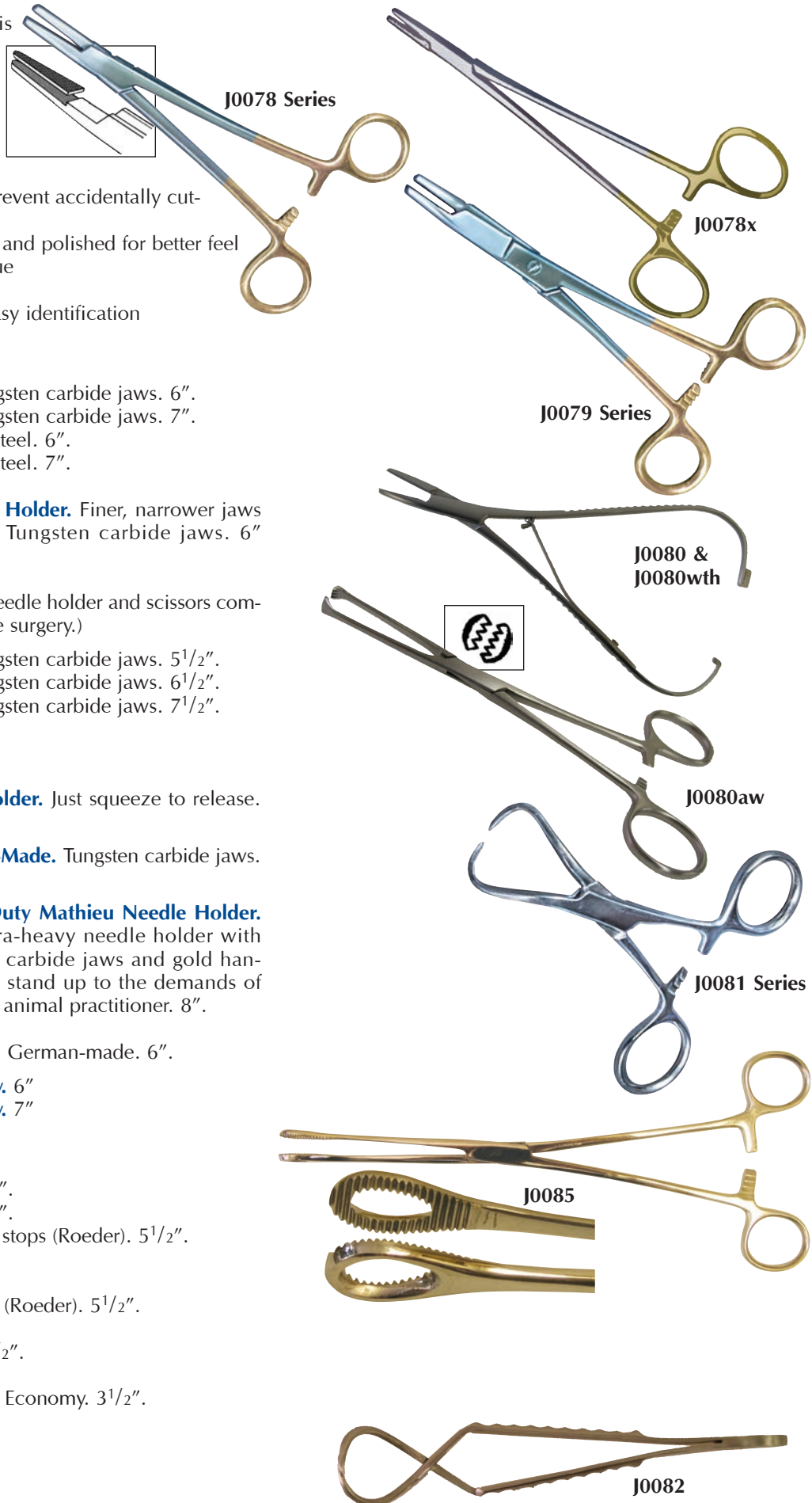



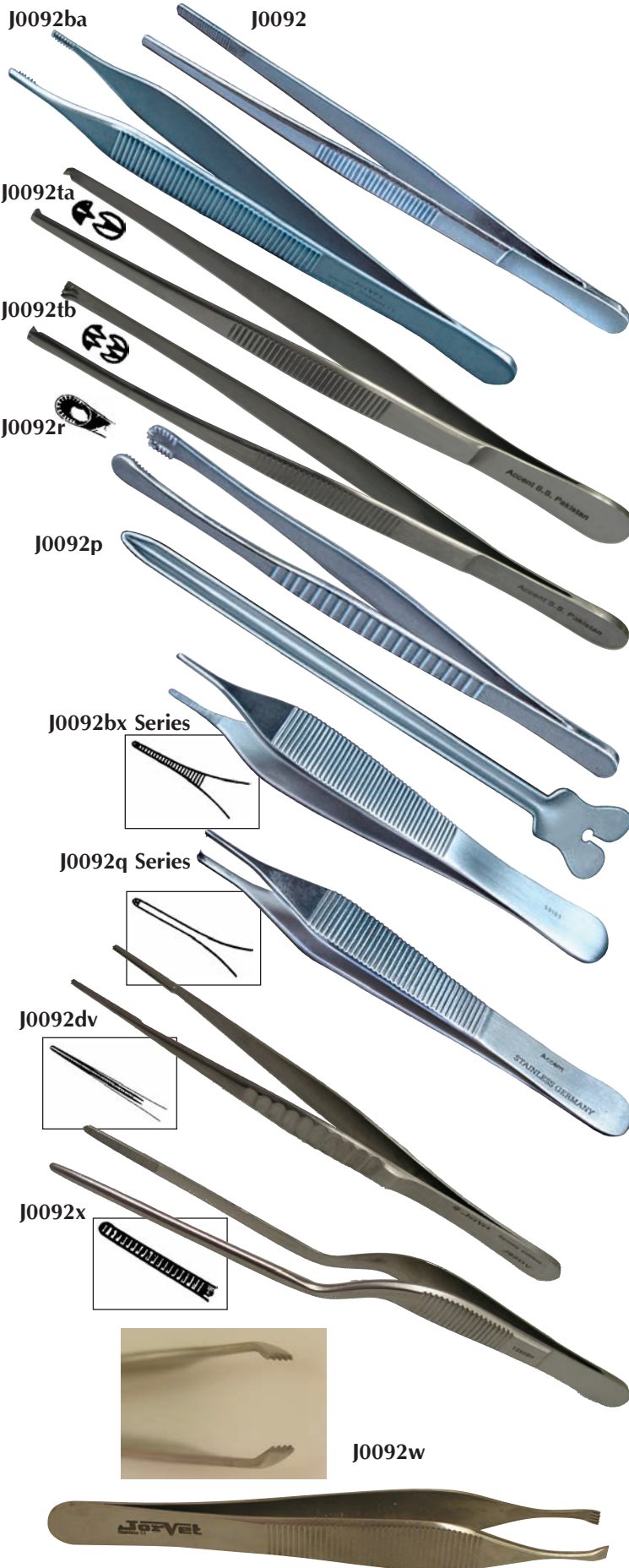

- J0092** **Thumb Forceps.** 5<sup>1</sup>/<sub>2</sub>".
- J0092ba** **Brown Adson Forceps.** 7 x 8 microteeth. 4<sup>1</sup>/<sub>2</sub>".
- J0092ta** **Tissue Forceps.** 1 x 2 teeth. 5<sup>1</sup>/<sub>2</sub>".
- J0092taw** **Tissue Forceps.** German-made. 1 x 2 teeth. 5<sup>1</sup>/<sub>2</sub>".
- J0092tb** **Tissue Forceps.** 2 x 3 teeth. 5<sup>1</sup>/<sub>2</sub>".
- J0092tbw** **Tissue Forceps.** German-made. 2 x 3 teeth. 5<sup>1</sup>/<sub>2</sub>".
- J0092tc** **Tissue Forceps.** 3 x 4 teeth. 5<sup>1</sup>/<sub>2</sub>". (not pictured)
- J0092tcw** **Tissue Forceps.** German-made. 3 x 4 teeth. 5<sup>1</sup>/<sub>2</sub>". (not pictured)
- J0092td** **Tissue Forceps.** 4 x 5 teeth. 5<sup>1</sup>/<sub>2</sub>". (not pictured)
- J0092r** **Russian Tissue Forceps.** Stainless steel. 6".
- J0092p** **Groove Probe Director.** Stainless steel. 5".
- Adson Dressing Forceps.** Serrated, yet delicate. 4<sup>3</sup>/<sub>4</sub>" (12cm).
- J0092bx** **Dressing Forceps.** Economy.
- J0092bxw** **Dressing Forceps.** German-made.
- Adson Tissue Forceps.** Small delicate 1 x 2 teeth. 4<sup>3</sup>/<sub>4</sub>" (12cm).
- J0092q** **Tissue Forceps.** Economy.
- J0092qw** **Tissue Forceps.** German-made.
- J0092dv** **DeBakey Vascular Tissue Forceps.** Delicate. 1.5mm tips. 6" (15cm).
- J0092x** **Lucae Forceps.** Offset tip allows the surgeon to see better (i.e., using a sponge in a deep cavity). 5<sup>3</sup>/<sub>4</sub>" (14cm).
- J0092w** **Beasley Babcock Forceps.** Wide fine tooth jaws make this a favorite instrument for holding tissue while suturing. 5<sup>1</sup>/<sub>2</sub>".

**J0240 Gelpi Retractors.** Retractors allow exposure into deep surgical fields. German-made. Stainless steel. 18cm (7").

**J0240e Economy Retractors.** Stainless steel. 7".

**J0240m Mini Retractors.** German-made. 5 1/2" (14cm).

**J0240me Mini Economy Retractors.** 5 1/2" (14cm).

**J0240ma Super-Mini Gelpi 3 5/8" Retractors.** The smallest of Gelpi, about one-half the size of a standard Gelpi. Jaw gap 45mm flat arms. (not pictured)

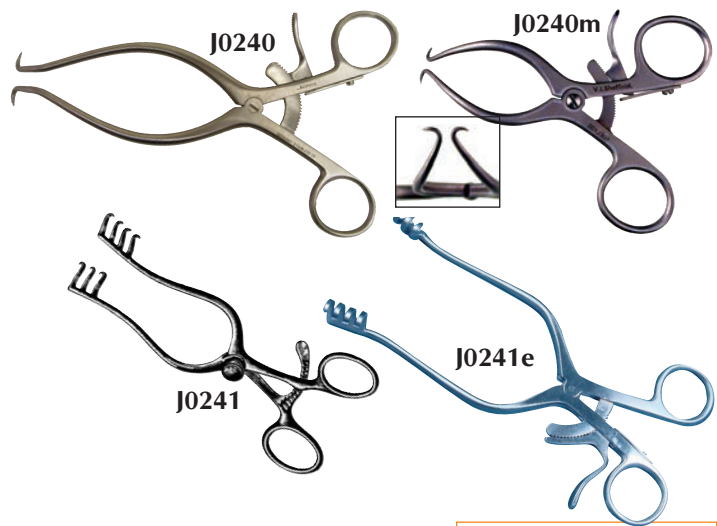

**J0241 Weitlaner Retractor.** Stainless steel. Blunt hooked retractor. German-made. 18cm (7").

**J0241e Economy.** Stainless steel. 7".

**J0241ma Super-Mini Weitlaner 3 5/8" Retractors.** Introducing the smallest of Weitlaner, at one-half the size of a standard retractor. Jaw gap of 45mm. (not pictured)

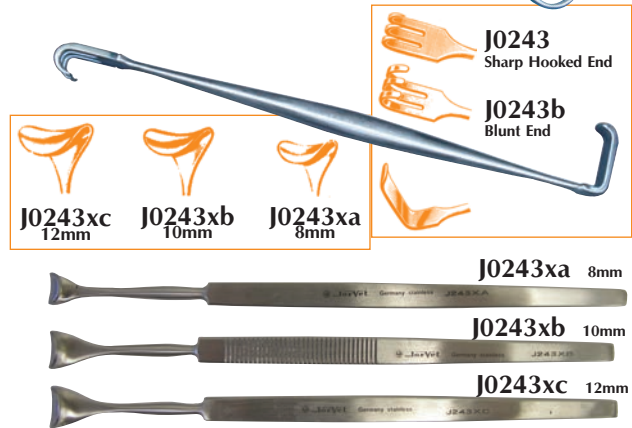

**J0243 Senn-Mueller Retractor.** Double end retractor. Three sharp hooks on one end and a wide plate on the other end. 16cm (6 1/4").

**J0243a Stifle Pad Retractor**

**J0243b Senn Retractor.** Blunt-ended prongs. 6 3/8".

**Des Marres Lip Retractor.** Blunt hand held retractor with varying widths. 16cm (6 1/4").

**J0243xa Retractor.** 8mm head.

**J0243xb Retractor.** 10mm head.

**J0243xc Retractor.** 12mm head.



**J0243g Gillies Small Tip Retractor.** Very delicate hook tip for retraction of fine nerves and vessels. Stainless steel. 7" (18cm).

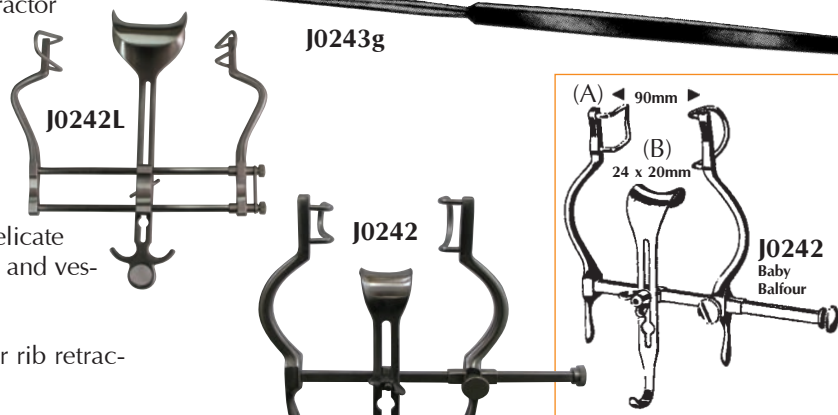

**Balfour Retractor.** The preferred instrument for rib retraction or laparotomy incisions.

**J0242 Balfour Retractor, Baby.** Works well for most small animals under 60 lbs.

**J0242L Balfour Retractor.** See diagram at right: (A) 180mm (B) 45 x 80mm.

**J0242q Finochietto Rib Spreader.** 8" (20.3cm) spread. 65mm W x 48mm D blades.

**J0242qm Rib Spreader, Mini.** 3" (75mm) spread. 20mm W x 18mm D blades.

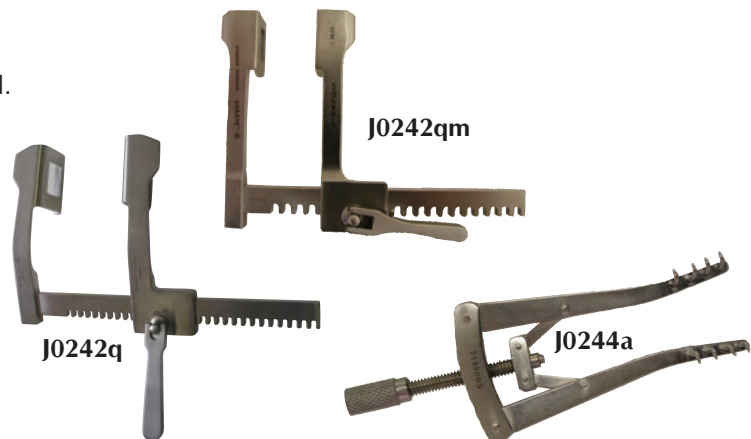

**J0244a Alm Retractor Sharp.** Very small retractor. Works very well with small exotics or avian patients. Stainless steel. 2 3/4" (7cm).

**J0894 Taylor Percussion Mallet.** Great for neurological exams. Red rubber mallet, stainless steel handle. 7" (18cm) L.

**J-894e Economy Percussion Mallet.**

**J0895 Young Tongue Forceps.** This instrument has rubber jaws that grasp and hold the tongue in atraumatic fashion. Stainless steel. 6<sup>3</sup>/<sub>4</sub>" (17cm) L.

**J0895d1 Replacement rubber tips.**

**J0896 Ferguson Stone Scoop.** Great for removing small uroliths in the bladder. Stainless steel.

**J0112a Snook's Spayhook.** Flat. Stainless steel. 8".

**J0112b Covault's Spayhook.** Probepoint. Stainless steel. 8".

**J0112m Mini Spay Hook.** The first spay hook small enough for kittens and puppies. The increasing popularity of spaying at younger ages and small sizes makes the demand for smaller equipment. The spay hook has no ball and a narrow hook width of 3mm versus standard 5mm and a shorter length of 6<sup>1</sup>/<sub>2</sub>".

**Soft Edged Surgical Spoons.** Removing calculi from the bladder or impacted feces from the rectum requires great care to avoid damage. 'Domestic' spoons are typically too sharp and too short for the purpose. Our soft edge spoons have been designed and manufactured with veterinary procedures in mind. Available in two sizes.

**J1225 Small.** 20 x 25 x 250mm. Suitable for feces and small bladders.

**J1225a Large.** 67 x 34 x 270mm. Suitable for the bladder.

**J1225b Xsmall.** 15 x 8 x 230mm.

**J1225s Set** of 3 sizes.

**EZ Hanger** Magnetic Instrument Holder lets you get organized. Tired of combing through drawers looking for your favorite nail trimmer? Place all of your favorite and most commonly utilized instruments within easy reach with the **JorVet Magnetic Instrument Holder**. The powerful magnet firmly holds scissors, tourniquets, hemostats, and nail trimmers. It gives a professional look to your exam and treatment room.

**J1134a Free standing rack** measures 11" high with rubber bumpers to reduce sliding.







J0660



J0661



J0662



J0663



J1370 series

**Jorvet and Aesculap AG** join together to introduce a premium line of surgical hand instruments.

Aesculap AG of Germany is the largest manufacturer of surgical instruments in the world. Aesculap surgical instruments are used in the top human hospitals throughout the world.

Features:

- Multi-step quality control
- ISO 9001 certification
- Lifetime warranty against defects in workmanship
- All instruments feature tungsten carbide inserts
- Gold-plated rings

**Needle Holders.** For the surgeon who demands the best! A solid grip to hold the suture needle tight.

**Olsen Hegar.** Combination scissors with needle holder.

**J0660** Olsen Hegar. 5<sup>1</sup>/<sub>2</sub>".

**J0660a** Olsen Hegar. 6<sup>1</sup>/<sub>2</sub>".

**Mayo Hegar.**

**J0661** Mayo Hegar. 6".

**J0661a** Mayo Hegar. 7".

**Scissors.** Razor sharp cutting bevel that really holds an edge. Serrated carbide cutting edge.

**Metzenbaum Scissors.** Finer tip for more delicate dissection.

**J0662** Scissors, Straight. 5<sup>3</sup>/<sub>4</sub>".

**J0662c** Scissors, Curved. 5<sup>3</sup>/<sub>4</sub>".

**J0662d** Scissors, Straight. 7".

**J0662dc** Scissors, Curved. 7".

**Mayo Scissors.** Heavier scissors.

**J0663** Scissors, Straight. 6<sup>3</sup>/<sub>4</sub>".

**J0663c** Scissors, Curved. 6<sup>3</sup>/<sub>4</sub>".

**Retractable Scalpel Handle with Blade.** This scalpel has a safety feature that allows the scalpel blade to be retracted inside the handle. Another unique feature is the universal retraction. Both right and left handed surgeons can operate the retraction clips.

- After incision is complete, simply retract the blade.
- Working outdoors with large animal procedures, safely retract the blade between patients.
- Audible 'click' when the blade is locked in retraction position.
- Sterile, 10/pk

**J1370a** #10 blade

**J1370b** #15 blade

**J1370c** #20 blade

JorVet offers two ranges of **Surgical Scalpel Blades:**

- Swann-Morton carbon steel blades
- JorVet stainless steel blades

**J0054s Sterile Swann-Morton Scalpel Blades.** Made from the finest carbon steel. Sizes stocked: 10, 11, 12, 15, 20, 21, and 22. These sharp blades are the result of years of experience plus modern production methods. Individually wrapped. 100/pkg.

**J0055d Sterile, Swann-Morton Disposable Scalpel.** Sizes 10, 11, 12, 15, 20, 21 and 22. 10/box. (not pictured)

**JorVet Stainless Steel Surgical Scalpel Blades.** Razor sharp blades. Gamma sterilized. Individually foil wrapped. 100/box.

- |               |                     |               |                     |
|---------------|---------------------|---------------|---------------------|
| <b>J0580s</b> | <b>Blades.</b> #10. | <b>J0584s</b> | <b>Blades.</b> #20. |
| <b>J0581s</b> | <b>Blades.</b> #11. | <b>J0585s</b> | <b>Blades.</b> #21. |
| <b>J0582s</b> | <b>Blades.</b> #12. | <b>J0586s</b> | <b>Blades.</b> #22. |
| <b>J0583s</b> | <b>Blades.</b> #15. |               |                     |

**Disposable Stainless Steel Scalpel.** ABS plastic handle attached. Each blade is protected with plastic (LDPE) cover. Sterile. Packaged in peel open foil wrap. 10/box.

- |              |                                       |
|--------------|---------------------------------------|
| <b>J0580</b> | <b>Disposable Scalpel.</b> #10 blade. |
| <b>J0581</b> | <b>Disposable Scalpel.</b> #11 blade. |
| <b>J0582</b> | <b>Disposable Scalpel.</b> #12 blade. |
| <b>J0584</b> | <b>Disposable Scalpel.</b> #20 blade. |
| <b>J0585</b> | <b>Disposable Scalpel.</b> #21 blade. |
| <b>J0586</b> | <b>Disposable Scalpel.</b> #22 blade. |

**J0055a Scalpel Handle.** Size 3.  
**J0055ga Handle.** German-made. Size 3.

**J0055b Scalpel Handle.** Size 4.  
**J0055gb Handle.** German-made. Size 4.

**Plastic Scalpel Handle.** Red plastic handle. Lightweight and larger than metal handles.

- |                |   |
|----------------|---|
| <b>J0055pa</b> | <b>Handle.</b> Fits same blades as #3 handle. |
| <b>J0055pb</b> | <b>Handle.</b> Fits same blades as #4 handle. |

**Folding Scalpel Handle.**

- |                |   |
|----------------|---|
| <b>J0055fa</b> | <b>Folding Scalpel Handle.</b> Size 3. (not pictured) |
| <b>J0055fb</b> | <b>Folding Scalpel Handle.</b> Size 4. (not pictured) |

**Micro Scalpel Blades.** These fine Swann Morton blades are less than half the size of standard scalpel blades. Useful for fine delicate surgery. Similar to Beaver blades. Sterile. 25/box. Autoclavable.

- |               |   |
|---------------|---|
| <b>J0890</b>  | <b>Scalpel Handle.</b>                            |
| <b>J0891a</b> | <b>Blade.</b> #65. Similar to standard #11 blade. |
| <b>J0891</b>  | <b>Blade.</b> #64. Similar to standard #10 blade. |

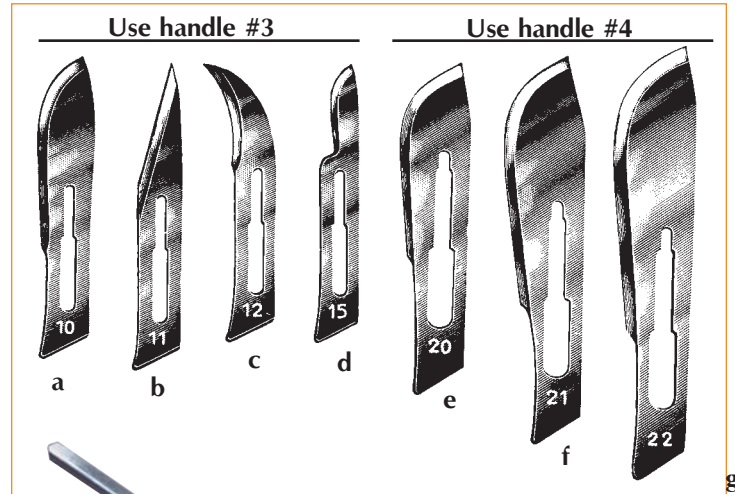

**J055a & J055ga**

**J055b & J055gb**

**J055pa & J055pb**

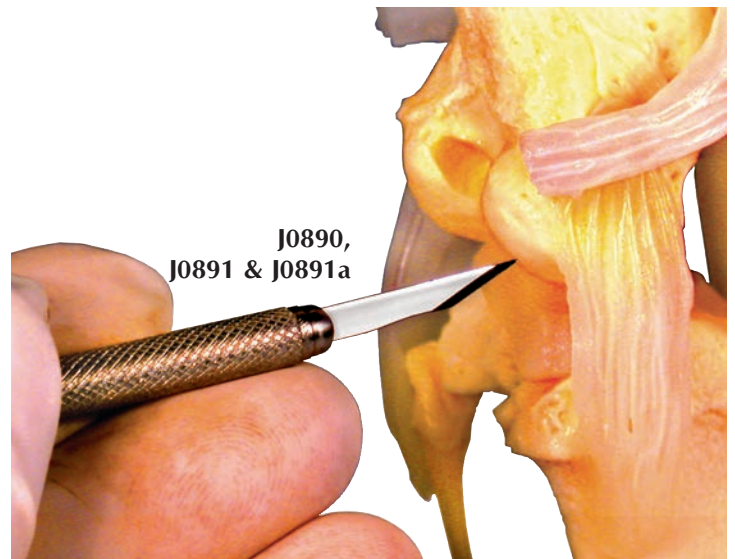

**J0480 Sterilization Pouches.** Pre-formed pouches with self-adhering adhesive tape features one blue-tinted side for visualization of contents, with other side paper-backed. Will work with either steam autoclave or ethylene oxide gas sterilization.

- J0480a Pouches.** 3<sup>1</sup>/<sub>2</sub>"W x 10"L. 200 bags/box.
- J0480b Pouches.** 5<sup>1</sup>/<sub>4</sub>"W x 11"L. 200 bags/box.
- J0480c Pouches.** 7<sup>3</sup>/<sub>8</sub>"W x 13"L. 200 bags/box.



J0480

**J0481 Sterilization Tubing** for sterile packaging of instruments. Cut off appropriate length from 100' roll. Blue-tinted side for visualization, other side paper-backed. Will work for either ethylene oxide or steam autoclaving.

- J0481a Roll.** 2"W x 100'.
- J0481b Roll.** 3"W x 100'.
- J0481c Roll.** 4"W x 100'.
- J0481d Roll.** 6"W x 100'.

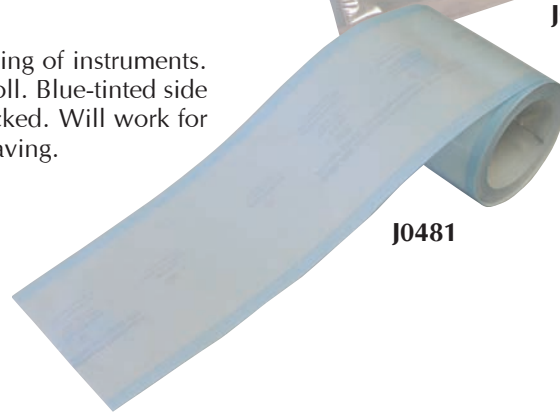

J0481

**J0435 Surgical Skin Marker.** These surgical skin markers are routinely used in human cosmetic surgery. The special ink allows for ready identification of anatomical landmarks to be done before surgery. The markers come sterile and each have their own flexible metric and inches ruler. Color works on all ranges of pigmented skin. For best results, remove oil from the skin using alcohol before marking. 2/pk each in an individual sterile package.

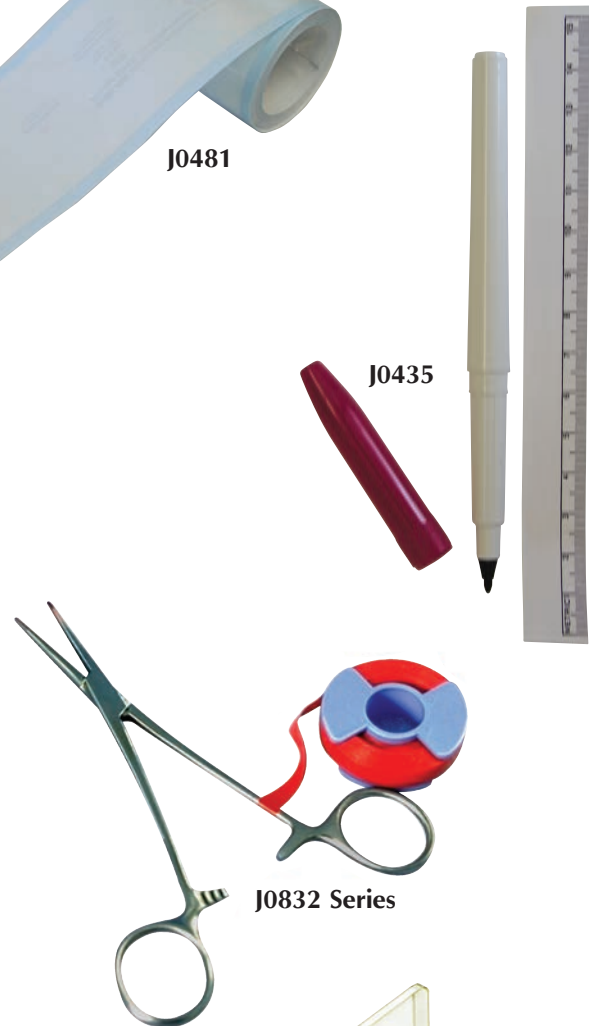

J0435

**Instrument ID Tape.** These colored tapes are ideal for identifying instruments and sorting them into their correct surgical packs. This will help avoid the frustration of opening a sterile pack only to find a key instrument missing.

The tapes are easy to apply and see so the right instrument can be identified every time. Autoclavable. 1/4" x 25' roll.

- J0832b Tape.** Royal Blue.
- J0832g Tape.** Kelly Green.
- J0832r Tape.** Red.
- J0832p Tape.** Purple.
- J0832f Tape.** Fluorescent Orange.
- J0832s Tapes.** Set of all five colors.

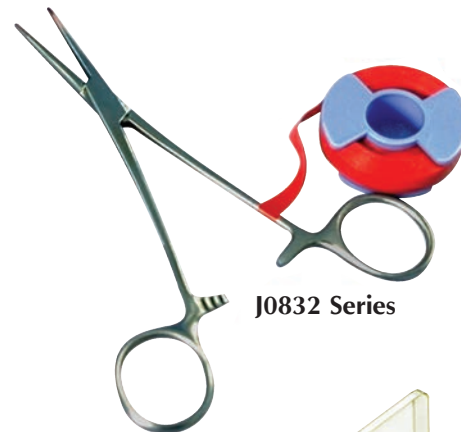

J0832 Series

**J0832x Color Code ID Rings.** Identifies hand instruments. Autoclavable. Assorted colors. 100/pk. (Will not work on instruments with finger rings.)





J0832x  
Storage Container Not Included

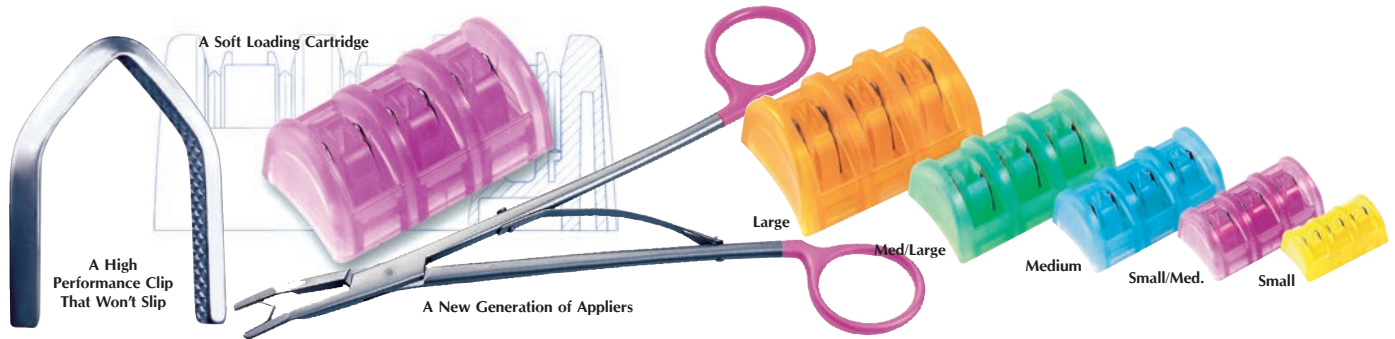

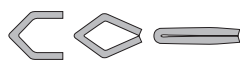

**Titanium Hemostatic Clip.** Pure titanium annealed to a malleable consistency providing maximum vessel occlusion and zero memory to prevent tip opening after application. Biologically inert, radiolucent and non-magnetic for use with MRI or related scanning equipment.

 Chevron shape provides progressive and encompassing tip-to-tip closure before complete and secure occlusion of tissue or vessel.

 Diamond-shaped grooving and interlocking atraumatic teeth design of the clip ensures enhanced security in vessel closure. Striation is composed of small pyramidal heads, similar to tungsten inserts from needle-holders, insuring a firm, multi-directional, non-hurting vessel grip.

Triangular-shaped wire fits perfectly into the custom grooves of our applicators to provide mechanical power during application of the clip.

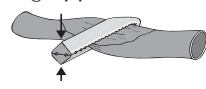
 Specially designed surface treatment and annealing provide a secure atraumaticity.

The exclusive small/medium size has been designed to match specific intermediary vessel sizes requested by surgeons.

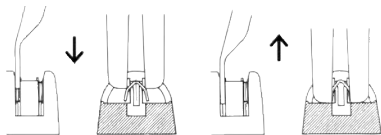

The cartridge is designed with effective clip retention, adhesive cartridge backing, and ergonomic design to insure precise and effortless clip loading.

**Cartridges**

Size	Color	Clip Closed	Clip Opened	Width
Small	Yellow	3.6mm H	2.9mm H	3.5mm W
Small/Med.	Lilac	4.6mm H	4.1mm H	4.5mm W
Medium	Blue	5.6mm H	4.7mm H	5.9mm W
Med./Large	Green	9mm H	7.8mm H	8.5mm W
Large	Orange	12.3mm H	10.8mm H	11.4mm W

**Apppliers**

Size	Color	15cm	19cm	28cm	28cm Right-Angled Jaws
Small	Yellow	<b>J0796a</b>	<b>J0796aL</b>	•	•
Small/Med.	Lilac	<b>J0796b</b>	<b>J0796bL</b>	•	•
Medium	Blue	<b>J0796c</b>	<b>J0796cL</b>	•	•
Med./Large	Green	•	<b>J0796d</b>	<b>J0796dL</b>	<b>J0796dLa</b>
Large	Orange	•	<b>J0796e</b>	<b>J0796eL</b>	<b>J0796eLa</b>

**Titanium Hemostatic Sterile Clips**

- J0795a Ligating Clips.** Small. 30 cartridges of 6 clips ea.
- J0795b Ligating Clips.** Small/Med. 30 cartridges of 6 clips ea.
- J0795c Ligating Clips.** Medium. 30 cartridges of 6 clips ea.
- J0795d Ligating Clips.** Med/Large. 20 cartridges of 6 clips ea.
- J0795e Ligating Clips.** Large. 20 cartridges of 6 clips ea.
- J0796a Clip Applicator.** Small. 15cm.
- J0796aL Clip Applicator.** Small. 19cm.
- J0796b Clip Applicator.** Med/Small. 15cm.
- J0796bL Clip Applicator.** Med/Small. 19cm.
- J0796c Clip Applicator.** Medium. 15cm.
- J0796cL Clip Applicator.** Medium. 19cm.
- J0796d Clip Applicator.** Med/Large. 19cm.
- J0796dL Clip Applicator.** Med/Large. 28cm.
- J0796dLa Clip Applicator.** Med/Large. Angled 28cm.
- J0796e Clip Applicator.** Large. 19cm.
- J0796eL Clip Applicator.** Large. 28cm.
- J0796eLa Clip Applicator.** Large. Angled 28cm.

**J0086 Michel Clip Forceps.** Can be used both for applying and removing Michel clips. Stainless steel. 12cm. 100 clips/rack.

- J0086a Clips.** 7.5mm x 1.75mm.
- J0086b Clips.** 14mm x 3mm.
- J0086c Clips.** 18mm x 3mm.

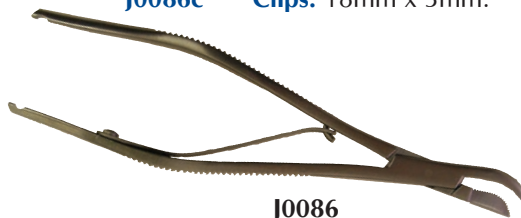

J0086a thru J0086c clips

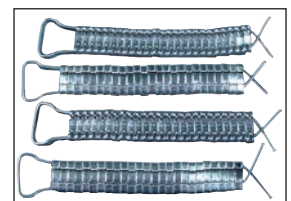

**Surgical Instrument Guards.** JorVet instrument guards are designed to protect valuable instrument tips from damage during sterilization and handling. Sharp and pointed tips can break through sterilization pouches and injure the surgeon. 50/pkg.

- Non-sterile, but can be autoclaved or gas sterilized
- Medical-grade plastic (vented)
- Guards can also work as covers over exposed bone pins.



J0926a	1/16" x 3/4"	(1.6mm x 19mm).	White.
J0926b	5/64" x 3/4"	(2.0mm x 19mm).	Blue.
J0926c	7/64" x 3/4"	(2.8mm x 19mm).	Green.
J0926d	1/8" x 1"	(3.2mm x 25mm).	Red.
J0926e	3/16" x 1"	(4.8mm x 25mm).	Yellow.
J0926f	13/32" x 3/4"	(10.3mm x 19mm).	Maroon.
J0926g	1/16" x 3/8" x 1"	(1.6mm x 9.5mm x 25mm).	Orange.
J0926h	5/64" x 5/8" x 1"	(2.0mm x 16mm x 25mm).	Brown.
J0926j	1/8" x 1" x 1"	(3.2mm x 25mm x 25mm).	Black.
J0926s	<b>Guards, Assorted Set.</b>		

**J0929 Retractor Guard** protects sharp retractor tips. Non-sterile, but can be autoclaved or gas sterilized. Packaged in 20-pack assortment of three sizes: 1 1/2" (38mm), 2" (50mm), and 3" (75mm) lengths.



**J0928 Instrument Clamp Covers.** These silicone covers assist in atraumatic clamping of delicate vessels or tissue (i.e., bowel during surgery). Covers slide over the jaws of instruments (i.e., Doyen forceps). Non-sterile, but can be steam autoclaved or gas sterilized. Packaged 12 per bag, four each of three sizes and colors:

- 2.5mm x 50mm (1/10" x 2"),
- 5mm x 50mm (2/10" x 2"),
- 7.5mm x 50mm (3/10" x 2").



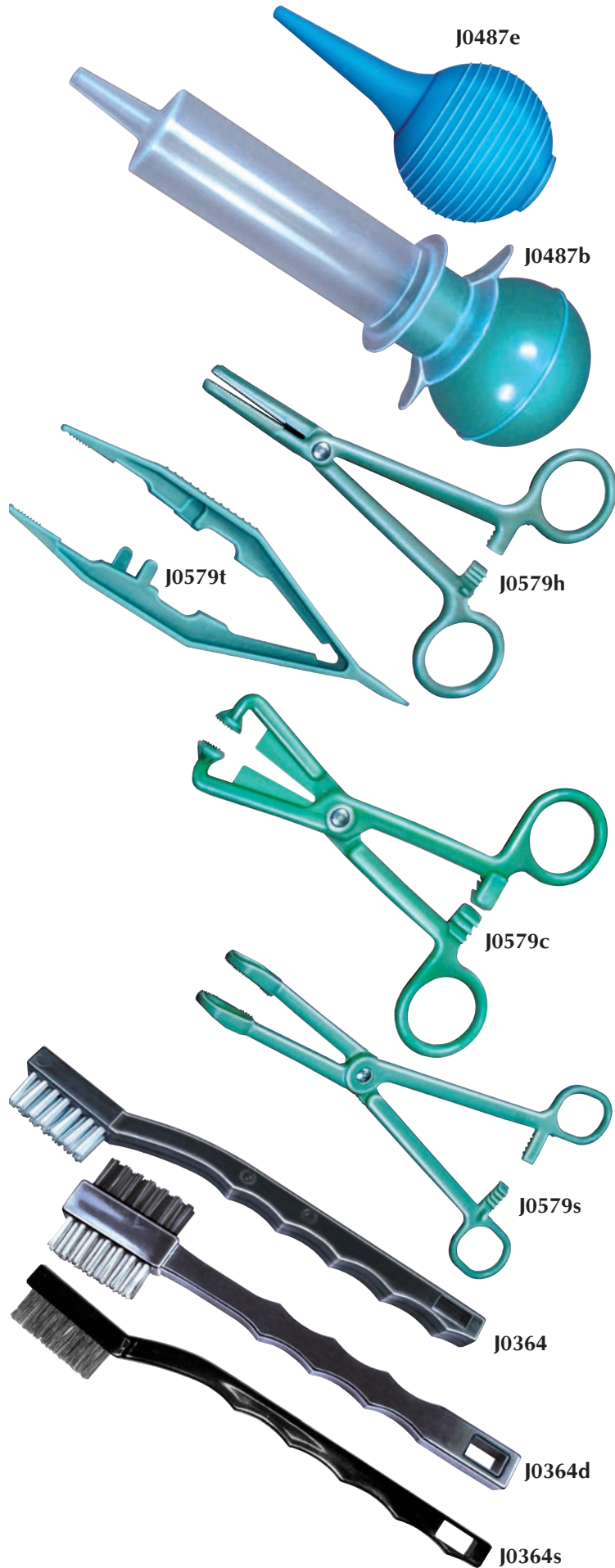

**J0486 Esmark Bandage/Tourniquet.** Latex roll that is excellent for bloodless surgical field (i.e., equine lower limb). (not pictured)

- J0486a Roll.** 4" x 12'. Sterile.
- J0486an Roll.** 4" x 12'. Non-sterile.
- J0486b Roll.** 3" x 9'. Sterile.
- J0486bn Roll.** 3" x 9'. Non-sterile.

**J0487e Ear Syringe.** The standard rubber bulb for aspirating fluids. **2 oz.** Sterile

- J0487d Ear Syringe.** 1 oz.
- J0487f Ear Syringe.** 3 oz.
- J0487e Ear Syringe.** 2 oz.  
**Most popular.**

**J0487b Bulb Syringe.** Excellent for aspiration of surgical sites. Also can be used to flush surgical sites. The rubber bulb is attached to a 60ml syringe, thus, 60ml capacity. Sterile.

**J0579 Nylon Surgical Hand Instruments.** These instruments are useful for a variety of clinical uses at a very affordable price. These instruments will come in handy for a lot of non-surgical procedures.

- Autoclavable
- Will not rust
- Very inexpensive
- Non-repairable

- J0579t Thumb Forceps.** 4<sup>1</sup>/<sub>2</sub>".
- J0579h Hemostat Forceps.** 5".
- J0579c Towel Clamp.** 5".
- J0579s Sponge Forceps.** 8".

*NOTE: Not intended for everyday surgical use.*

**Surgical Instrument Cleaning Brush.** For proper cleaning of expensive surgical instruments. These brushes will remove all tissue residue and dried blood from hard to reach areas on surgical instruments. 7"L.

- J0364 Nylon Bristle.**
- J0364d Double-Sided Brush** with both nylon and stainless steel bristles.
- J0364s Stainless Steel Bristle** for burrs and rasps.





**pH Neutral Instrument Cleaning Detergent.** Ultrasonic and manual cleaning detergent for surgical instruments.

- Very concentrated. 5ml makes 1 gallon
- Works on metals, rubber, plastic and glass
- High suds with rust inhibitor
- Dispenser pump included
- Available 4 gallons/case

**J0647 pH Neutral Instrument Cleaning Detergent.**  
1 Gallon.

**Enzymatic Instrument Cleaning Detergent.** This cleaner is excellent for removing stubborn organic debris that can stain your surgical instruments. It is a blend of four different enzymes to be the most effective cleaner available.

- Free of metal attacking agents. Does not contain scale forming phosphates, chlorides or hydroxides
- Concentrated for best economy. Only 1 oz. (30ml) is needed for 1 gallon of wash solution
- Cleans a wide range of metal surfaces. Safe and effective for stainless steel, aluminum, tungsten carbide, copper and brass instruments
- Available 4 gallons/case

**J0649 Enzymatic Instrument Cleaning Detergent.**  
1 Gallon.

**Instrument Milk, Concentrate.** An absolute necessity for lubricating and protecting expensive surgical instruments. Use after every cleaning to extend the life of all types of stainless steel surgical instruments. Contains a special additive which dissolves organic debris that may build up in the box lock.

- Inhibits corrosion. Deposits anti-corrosive microfilm onto instrument surface
- Gentle ingredients. Formulated with non-aggressive and near neutral pH (7–8)
- 1 gallon makes 7 gallons of lubricant
- Available 4 gallons/case

**J0648 Instrument Milk, Concentrate.** 1 Gallon.

**J0382g JorVet Ultrasonic Cleaning Solution.** Gallon.

**J0400 Intrafix Air.** A new IV set from JorVet for use on either vented or non-vented IV fluid containers.

- Inexpensive for best value in IV sets
- Sterile

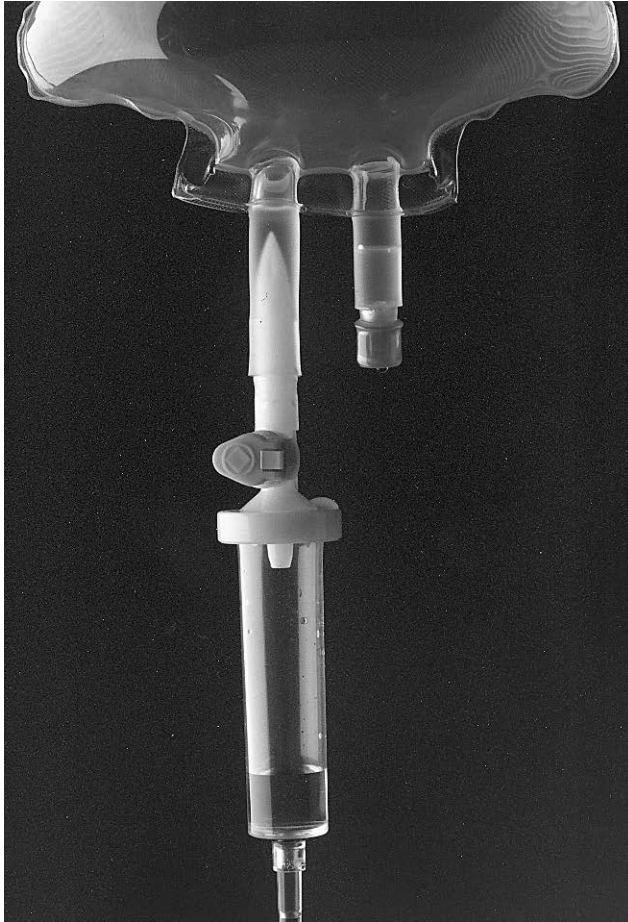

**J0400y Intrafix Air IV Set** with “Y” injection site.

- Same drip chamber features as J-400
- 78” soft elastic tubing
- “Y” latex injection site 6” from distal end
- Sterile

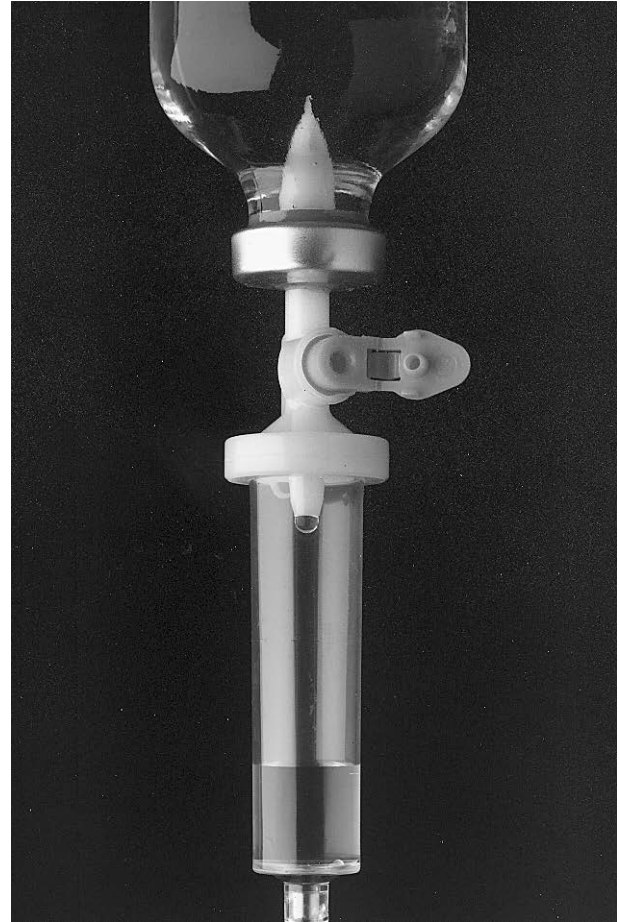

J0400

**Piercing Spike**  
can be easily inserted into all infusion containers. The smooth surface reduces the risk of rubber abrasion during insertion.

**Integrated Bacteria-Proof Air Vent.**  
in closed position works on non-vented collapsible IV bags. In open position works on vented rigid plastic or glass containers.

**Accurate Drop Former.**  
forms even, large drops for the required drop rates. 20 drops/ml.

**72” Soft Elastic Tubing.**  
assures an easy setting of the roller clamp. Air bubbles can be easily detected through the transparent tube material.

**Precision Roller Clamp.**  
Provides a reliable setting of the infusion. Frequent checks are not necessary.

**Luer Connector.**

**Latex Injection Piece.**  
ensures the hygienic injection of drugs





**J0466**

**IMPROVED**



**J0466**  
Spike and Vent

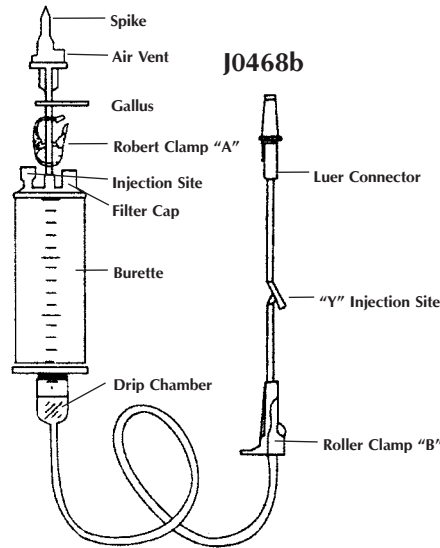

**J0468b**

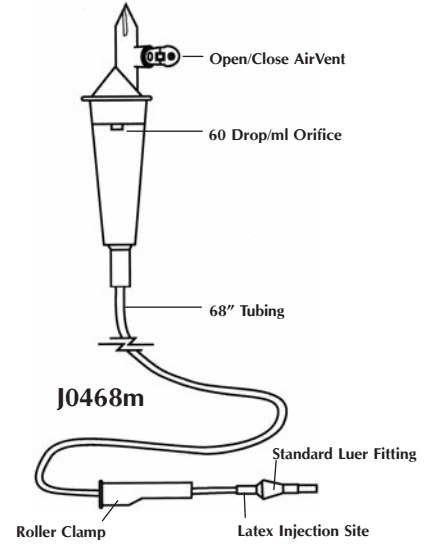

**J0468m**

**J0466 Large Bore Fluid Transfer Set.** Suggested for equine IV use. Large bore makes for faster administration of solutions. Short tubing is ideal for a standing horse. Sterile. 30"L.

**IV Burette Set.** This IV is for small precise volumes that can be accurately measured out in calibrated burette versus 1,000ml IV-fluid bags. Very useful for very small patients for accurate dosing.

**J0468b IV Burette Set,** calibrated for 100ml burette chamber. 68"L.

**J0468m Mini Basic Vented IV Set.** 60 drop/ml. The standard IV set except has 60 drops/ml drop orifice. This is the preferred set for fine control of fluid administration to really small patients. Sterile. 68"L.

**Longer Length IV Sets.** These sets eliminate the need for extension sets. There are 2 "Y" sites: one near the drip set and the other 8" from the distal end. Plus, there is a latex injection port at the distal end. 100" (250cm). Sterile.

**J0400a IV Set.** Standard 20 drips per ml.

**J0468ma IV Set.** Minidrip 60 drips per ml.

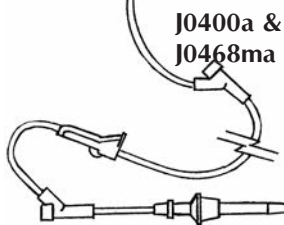

**J0400a & J0468ma**



**J0463a**



**J0463c**

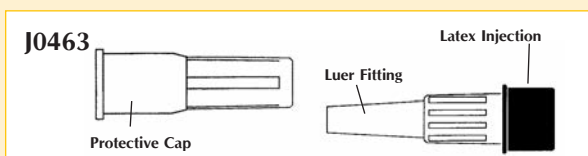

**J0463**

**J0463a Female to Female Luer Lock Adaptor.** Sterile.

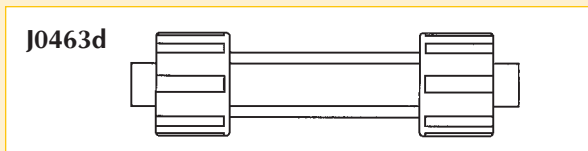

**J0463d**

**J0463c Male Luer blue cap with strap.** The strap allows the cap to be tethered to IV catheter to avoid losing it.

**J0463 Male Luer Adaptor.** Sterile latex injection port with protective cap. Made by Braun. Often used to cap catheters.

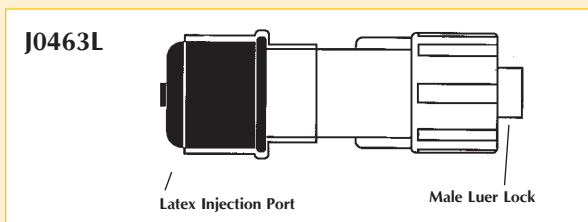

**J0463L**

**J0463d Dual Male Adaptor.** This connector has a male luer lock adaptor on each end. It allows the connection of two female luer fittings. Sterile. 5/pk.

**J0463L Male Luer Lock Adaptor.** Latex injection port. Sterile. 1 1/3"L.



**J0467s** **Standard Bore "T" Extension, with Luer Lock.** The distal end is a female luer slip, the proximal end is a male luer spin-lock. The standard bore tubing is equipped with a slide clamp. Injection port is latex-free. Priming volume is 0.69ml. 5"L. Sterile.

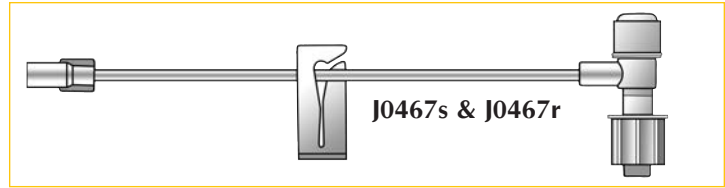

**J0467r** **Micro-Bore "T" Extension with Luer Lock.** Same configuration as **J0467s**, only with smaller micro-bore tubing. Sterile.

**J0467t** **Standard Bore "T" Extension Set.** Distal end has a female luer fitting. Proximal end has male luer slip with latex injection port. Also slide clamp for flow control. Sterile. 5"L.

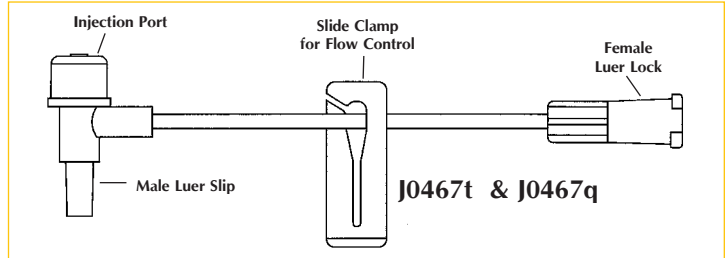

**J0467q** **Micro-Bore "T" Extension Set.** Same configuration as **J0467t** only with smaller bore tubing that is more suitable for smaller patients. Sterile.

**J0467y** **Extension Set.** Female luer slip needleless valve and opposite end male luer slip. Sterile. 6". (not pictured)

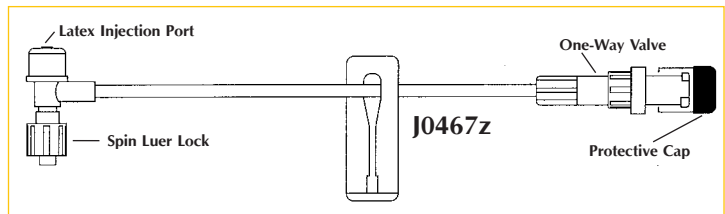

**J0467z** **T-Port Extension Set.** The open end is a needleless valve female luer slip. The opposite end is right angle male spin luer lock fitting that also has a latex injection port. Sterile. 13g x 7".

**J1316t** **Minibore bi-fuse 'T' connector extension set.**

- 2x female proximal luerlocks with caps
- 1 male spin distal luerlock
- 3 slide clamps
- Needle free injection site on top of 'T' port
- Length 5.5" (14cm)
- Priming volume 0.5ml

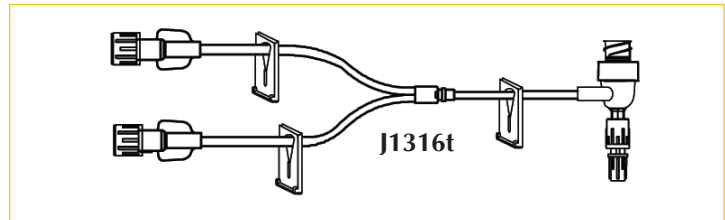

**Needle free IV accessories.**

*Note: Ultrasite needle free valves require a male luerlock for long term attachment. A luer slip will work short term.*

**J0467e** **Small bore "T" port extension set.** Ultrasite female luerlock needle free. Spin male luer lock. Latex free injection port. 5.5" length (14cm). 0.66ml priming volume. Slide clamp.



**J0467f** **Stand bore "T" extension set.** Ultrasite female luerlock needle free. Spin male luer lock. Latex injection port. 7.5" length (19.1cm). 1.3ml priming volume. Slide clamp.

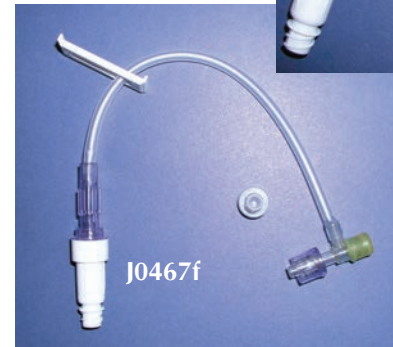

**J0467g** **"T" port extension set.** This set is different in that the "T" port itself is needle free. It will accept male luer lock and slip connections. Male spin luer lock. Micro bore tubing. Female luer lock. 5" length (12.7cm). 0.3ml priming volume. Slide clamp.

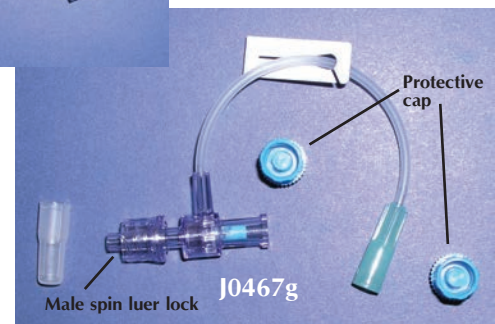

**IV Tubing terms:**  
**Standard:** most IV lines are greater than 0.1"  
**Mini or Small:** tubing with >0.04" and <0.1" to minimize its contained volumes. Sometimes used interchangeably with microbore.

**J1327**

**Bifuse Extension Set.**



- Standard bore
- 2 female luerlock with caps, proximal
- 1 male spin luerlock, distal
- 2 slide clamps
- Length 7"(18cm)
- Priming volume 1.6ml

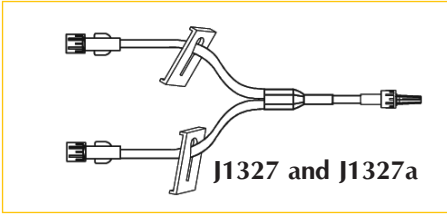

**J1327a**

**Bifuse Fuse Extension Set.**



- Microbore tubing
- 2 female luerlock without cap, proximal
- 1 male spin luerlock, distal
- 3 slide clamp
- Length 6"(15cm)
- Priming volume 0.6ml

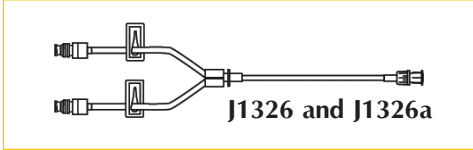

**J1326**

**Bifuse Extension Set.**



- Standard bore
- 2 needle free female luerlocks, proximal
- 2 slide clamps
- Male spin luerlock, distal end
- Length 8<sup>3</sup>/<sub>8</sub>"(21cm)
- Priming volume 1.1ml

**J1326a**

**Bifuse Extension Set.**



- Minibore
- Needle free connectors, proximal end
- 2 slide clamps
- Male spin luerlock distal
- Length 5"(13cm)
- Priming volume 0.8ml
- Sterile

**Minibore Extension Set.**

- Straight line
- Female luerlock, proximal end
- Male spin luerlock, distal end
- Slide clamp



**J1317a**

**Minibore Extension Set.** 30"(76cm)  
Priming volume 1ml

**J1317b**

**Minibore Extension Set.** 60"(152cm)  
Priming volume 1.8ml

**J1317c**

**Minibore Extension Set.** 6"(15cm)  
Priming volume 0.3ml

**J1321**



**Mini Anchor.** Designed to be placed or clipped on an IV line at the point where they may kink. This will help to stabilize the line, secure the catheter, and reduce occlusions. Maybe used instead of a J-Loop extension set. Nonsterile. 10pk. Flexible polyethylene. Will fit standard bore tubing.

- Length – 30mm
- Width across clips – 21mm
- Width across curve of anchor – 20mm

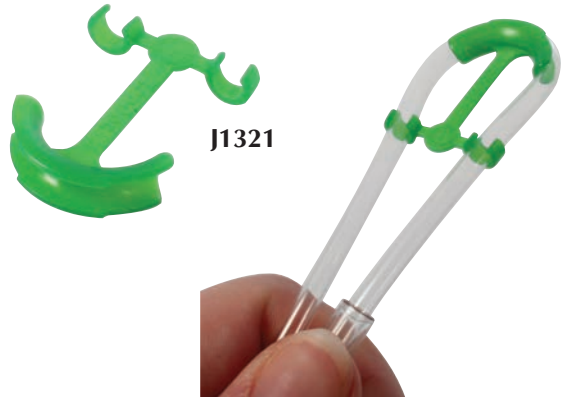

**J0467b**

**IV Extension set.**  
30" with male luer and female luer lock. 30" standard bore tubing. Sterile.

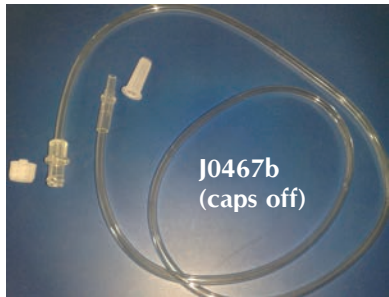

**J0467c**

**Extra long IV Extension Set.** 60" (150cm) male luer lock slip and female luer lock. Sterile.



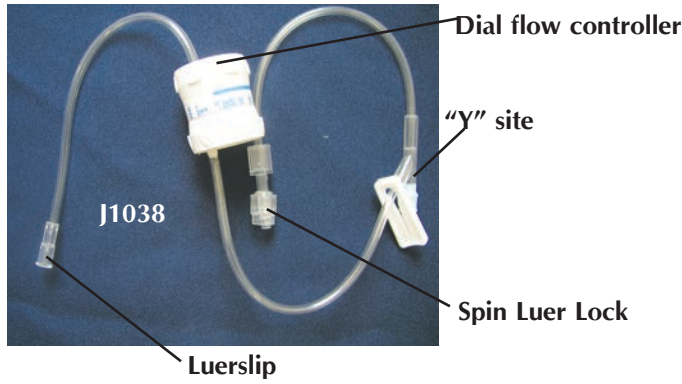

**J1038 Extension set** with flow rate regulator  
 This 19" extension set has an adjustable dial that controls the flow rate in ml/hr. It has a female luer fitting on one end and a male spin luer lock on the other. A "Y" site is located just below the controller.

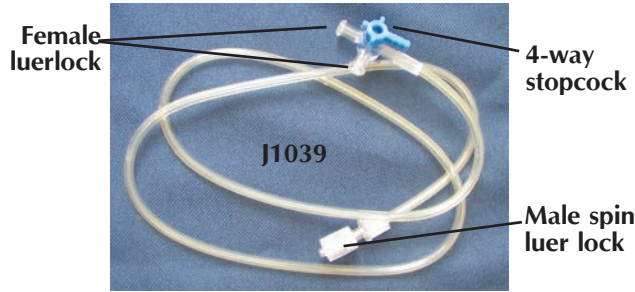

**J1039 IV Extension Set** with four-way stopcock. One end female luer slip and the other end is a male spin luer lock. Sterile.

**J1039a Extension Set** with two "Y" sites 32" length, with two slide clamps

- Male spin luer lock distal end,
- Female luer lock proximal end

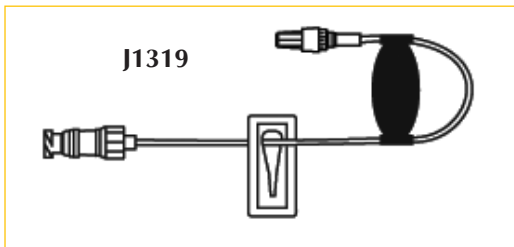
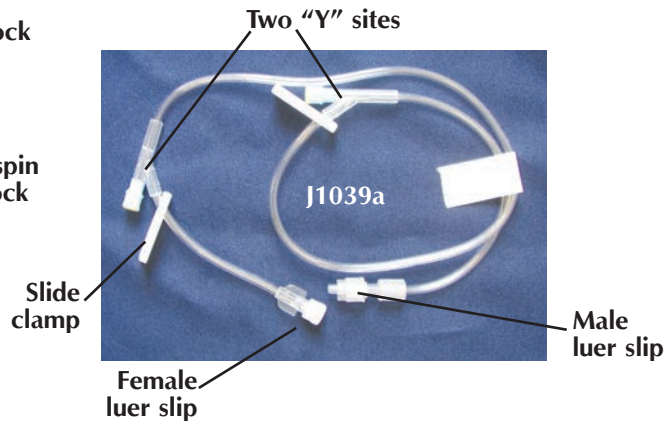

**J1325 J-Loop minibore extension set.** Rigid plastic bridge holds extension set into 'J' loop shape.

**NEW**

- Needle free valve female luerlock proximal end
- Male spin luerlock distal end
- 6.5"(17cm) length
- Priming volume 0.20ml
- Slide clamp

**J1039c Coiled IV Extension Set.** This coiled tubing allows the patient to move around but keep the tubing at just adequate length just like a telephone cord. This helps to avoid kinking or tangling.

- 36" length
- Standard bore tubing
- Male luer lock/female luer ends
- Sterile

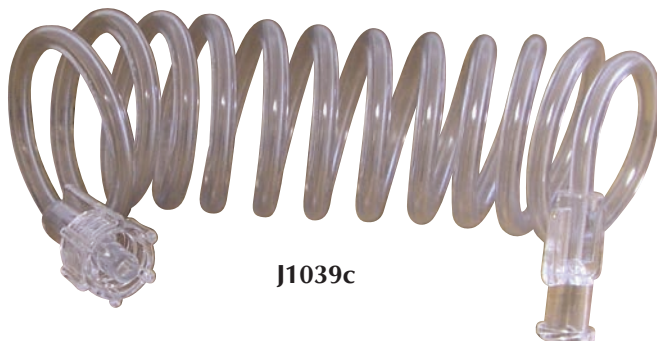



**J1105b** **“W” or Wye fluid line connector.**  
 • 3 female luerlocks to one male luer spin lock  
 • Clear plastic PVC  
 • Sterile  
 • Each



**J1105**

**J1105a** **T connector fluid connector**  
 • male spin luer lock  
 • 2 female luer locks at right angle to each other  
 • Sterile  
 • Each



**J1105a**

**J1105bb** **“W” or Wye fluid line connector.** 10/pk. Nonsterile.

**J1105ab** **T connector fluid connector.** 10/pk. Nonsterile.

**J1112** **Suture wing blue 7fr (2.3mm) thru channel**  
 • 2 suture holes  
 • Pass fluid, NG tube, or line catheter thru underside  
 • Pebax material  
 • 10/pk  
 • Non-sterile

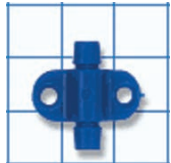

**J1112**



**J1112a** **Suture wing white 4.5fr thru channel**  
 • 2 suture holes  
 • Pass fluid, NG tube, or catheter thru underside  
 • 10/pk  
 • Non-sterile



**J1112a**

**J1142** **Blood Administration set**  
 • Dual spike blood/saline  
 • 10 drops/ml  
 • 3 roller clamps  
 • 170 micron blood filter  
 • “Y” injection site 6” above distal end  
 • Latex free  
 • Priming volume 34ml  
 • Spin luer lock distal connector  
 • 98” (249cm) length

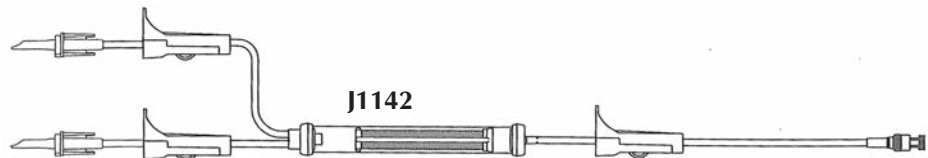

**J1142**

**J1137** **Eclipse® Elastometric Infusion Devices.** These fluid pumps are an elastic balloon. The fluid inflated balloon forces fluid out at a controlled rate based on its size and tubing diameter. It is very useful for highly accurate delivery or slow controlled dosages of: antibiotics, pain medication or chemotherapy. Kit includes 100 ml fluid pump, tubing provided 0.5ml/hr. Other sizes available.

**J1137a** 125ml volume. 5ml/hour.  
**J1137b** 100ml volume. 50ml/hour.  
**J1137c** 100ml volume. 2ml/hour.

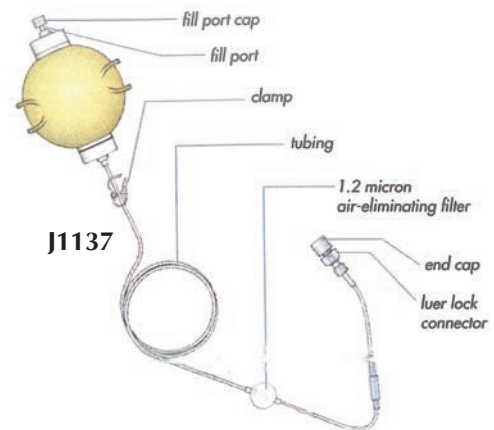

**J1137**

**TUR/cysto large bore irrigation sets.** Often useful for arthroscope irrigations. Unispike allows use with rigid or collapsible fluid bags. Large bore tubing 0.2” in diameter. On/off clamps plus roller clamp. Soft flexible 4.5” distal connector. Drip chamber. Latex free. Sterile.

**J1140** **Single spike set** 79” (200cm) length  
**J1140a** **Dual spike set** 94” (239cm) length



**J1140**

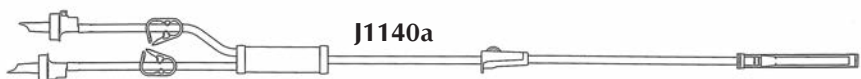

**J1140a**

**Innovative Drug Delivery Systems.** JorVet offers connectors or adaptors as aides to mixing and administering various medications. Many freeze-dried preparations or other multi-dose vials benefit from using these aides. Increasing use of feeding and PEG tubes, and other catheters (i.e. Foley), make getting the right connection important.



**J0591 Mini-Spike Dispensing Pin with Air Vent.** Great for preparing and dispensing diluent from multi-dose rubber-stopped vials (i.e., Naxcel). Utilizes a bacterial retentive air-venting filter. Female luer lock attachment. Sterile. 5/pk.

**J0596 "Y" Barbed Connector.** 8mm. 2/pk.  
**J0596a Small "Y" Barbed Connector.** 4mm. 2/pk.

**J0282d1 Barbed Connector with Female Luer Lock.** Allows connecting of syringe to catheter (i.e., Foley or feeding tube)

**J0282d2 Double Christmas Tree Connector.** Connects tubing from 4mm to 12mm i.d. 2/pk.

**J0282d3 Smaller Christmas Tree Connector.** 4mm to 6mm. Not tapered. 2/pk.

**J0282d4 Smaller Barbed Connector** with female luer lock. 2.8mm–7mm.

**J0599 Male Luer Lock Connector** with male is barbed on a Christmas tree connector. Also fits in a suction hose. 2/pk.

**J0463q Ultrasite IV Adaptor.** Braun needle free product. Cap off or plug your IV catheter with needle free valve. Other end is a male luer fitting. Ultrasite with blue plunger. Sterile.

**J0463x Needle Free Multi Dose Vial Adaptor.** Allows needle free "syringing" from rubber multi-dose vial bottles without the risk of contamination.

**J0594 Dual Pinch Nylon Clamp.** Slides over tubing for flow control. Accepts up to 6.6m (20fr) tubing. 5/pk.

**J0594a Dual Pinch Nylon Clamp.** Larger size. Slides over tubing up to 3.4" or 19mmOD. 5/pk.



J0591

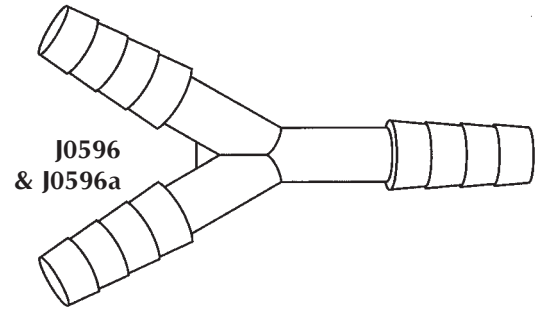

J0282d1  
J0282d4

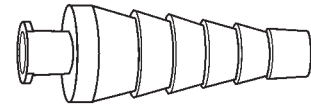

J0282d2

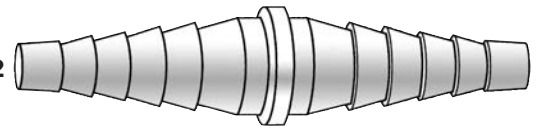

J0599

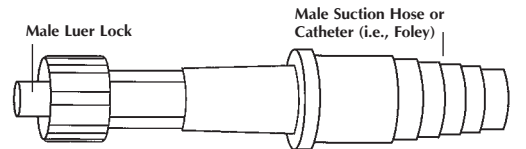

J0463q

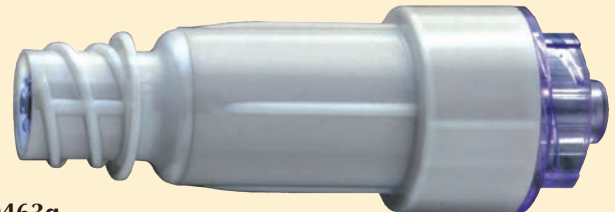

J0594

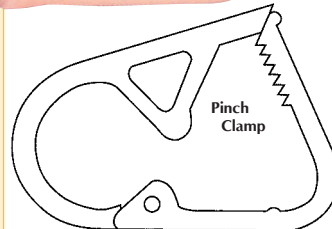
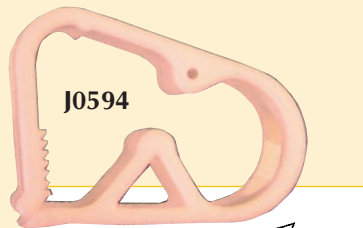

Fits Tubing:  
 J0594 up to 6.6mm  
 J0594a up to 19mm

J0463x

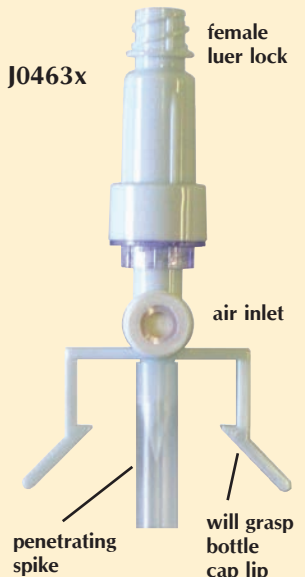

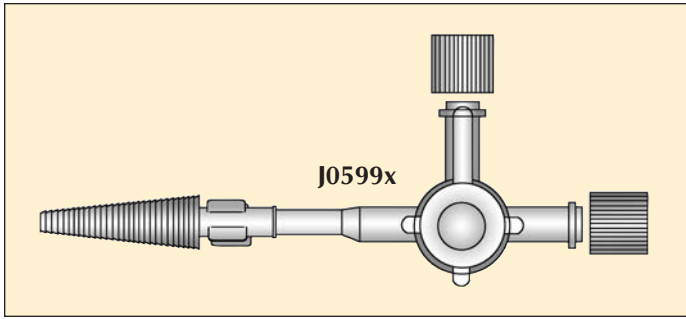

**J0599x Three-Way Stopcock** permanently attached to male-barbed connector. Stopcock has two female luer connectors that can be attached to: a luer syringe, IV-set, or “T” bore connector. The barbed connector can be attached to: Foley, or other catheters, chest drain, or small stomach tubes. Sterile.

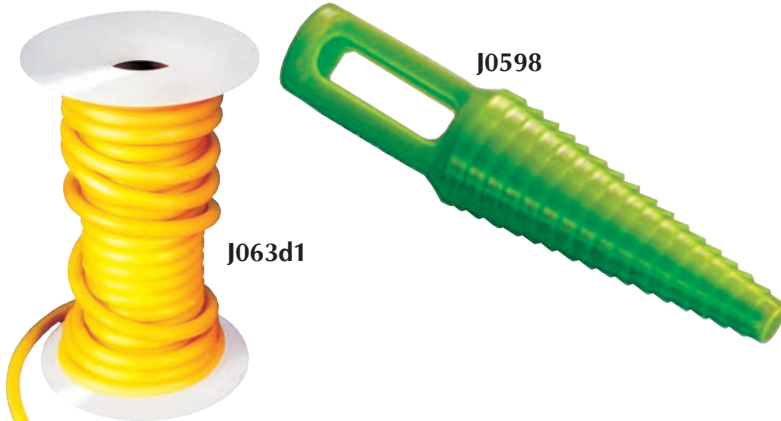

**J0598 Catheter Plug.** Designed to temporarily plug feeding tubes and catheters (i.e. Foley), when not in use. Thumb grip. Sterile. 5/pk.

**J063d1 IV Latex Surgical Tubing.** High quality stretch tubing for a variety of clinical needs. Can be autoclaved. 50’L.

- J-63d1** 3/16” i.d. x 5/16” o.d.
- J-63d1a** 1/8” i.d. x 3/16” o.d.
- J-63d1b** 1/4” i.d. x 7/16” o.d.

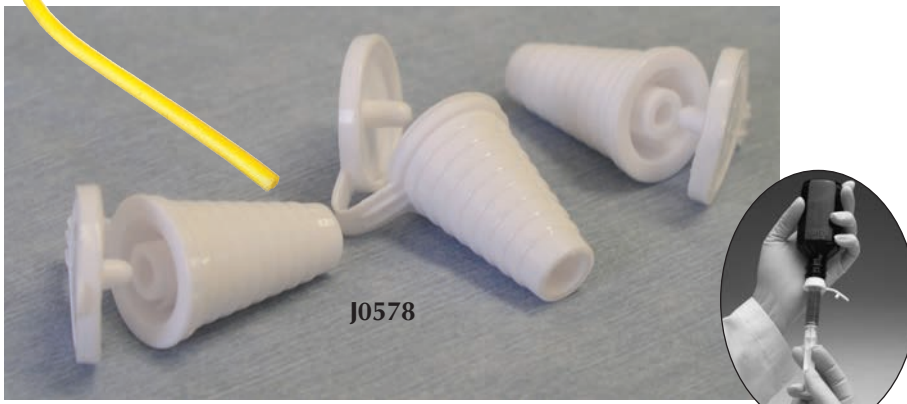

**J0578 Universal Bottle Adaptor.** This adaptor features a graduated rubber plug that fits bottle openings 18–22mm. The tethered plug lets you reseal the bottle for later use. Attach oral dose syringe and withdraw desired dose.

Will not work as well with a luer tip syringe.



**Springfusor**, a simple reusable spring-driver pump used for continuous IV infusions over time, requires no batteries or electricity. The pump is matched with various special sized tubing to determine actual flow rate. Uses include administering oncology and anesthetic drugs, and IV fluids to very small patients.

- Features:
- Large variety of flow rates available (e.g., 10ml, 15 to 60 minutes)
  - Compact and very portable
  - Reusable
  - No programming required
  - Not gravity dependent

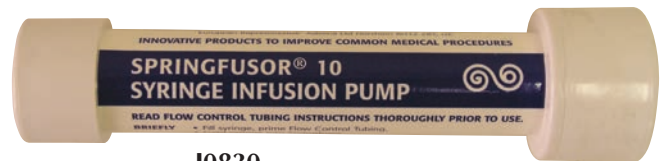

**J0830**

**J0830 Spring Infusor**, 10ml.

- Central Tubing.** 10/box.
- J0831a Tubing.** 10ml/15 minute.
  - J0831b Tubing.** 10ml/30 minute.
  - J0831c Tubing.** 10ml/60 minute.



**J0320p Infusible. 1-Liter.** Pressure infuser for collapsible IV bags. IV bag fits inside mesh and nylon bag.

A rubber hand pump attached to a 3-way stop cock allows bag to be filled with air, which exerts pressure on the IV fluid bag.

**J0320pl Infusible. 3-Liter.**



J0266e



J0266a

**J0266e Economy IV Stand.** The stand features a 21" dia. painted base, open casters, a knurled knob for adjustment, and a welded two-hook top. Adjustable 45"–83"H.

**J0266 IV Stand.** 24" dia. five-leg aluminum base is more stable than the economy model. Brushed chrome, dual caster, and four prong hooks. Adjustable 54"–84"H.

**J0266a IV Stand.** As above only with two prong hooks.

**IV Catheter Guard.** There is nothing more frustrating than working hard to place an IV catheter in a critically ill patient only to have the patient remove it. The IV Catheter Guards are a quick and inexpensive way to detour your patients from chewing or licking on their IV catheters. They are made of a thin lightweight flexible plastic with holes for air circulation. The IV catheter guard is held in place by velcro straps that wrap around the limb. The rough surface of the velcro seems to deter most patients from licking. Straps are reusable, but also inexpensive to replace if damaged. University tested and recommended.

Directions for Use: Select the correct size from the four sizes available. Loosen velcro straps. Place IVGuard over the catheter as shown. Wrap velcro straps around the leg and tighten on IV Guard Soak or gently scrub with disinfectant solution or bleach between uses. Four sizes available!



- J0644 Small Cats and small dogs**
- J0644a Medium** 20-40 lbs
- J0644b Large** 40-80 lbs
- J0644c X-Large** 80+ lbs
- J0644s Set of all four sizes**



**Jorvet Large Bore IV Catheter.** Large animals need large volumes of IV fluids in a short period of time. Naturally, the IV catheter needs to be a large bore, and often is even put in bilaterally to maximize fluid administration speed.

Features:

- Large bore: 10g and 14g catheters. The 10g is the largest available.
- Longer lengths: 5 1/2" catheter lessens the risk of pulling out the catheter.
- Pebax® catheter implant grade material: much less bioreactive to lessen thrombosis formation for long term >3 days placement.
  - Kink resistant: other catheters like Teflon will kink upon bending, making them unusable.
  - Clear catheter material versus opaque Teflon.
- Suture patch: a thin, flexible patch with twin eyelets. Allows suturing in place or hold with tissue adhesives. Reduces catheter pull-out.
- Competitive pricing and available through JorVet distributors.

**J0457a Catheter.** Sterile. 14g x 5 1/2".

**J0457b Catheter.** Sterile. 10g x 5 1/2".

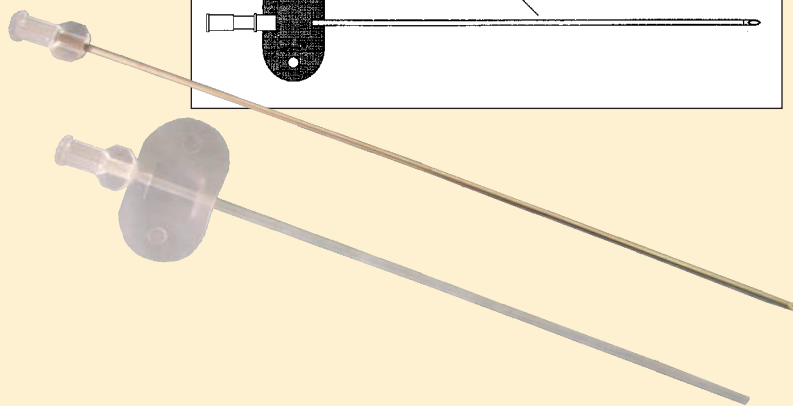
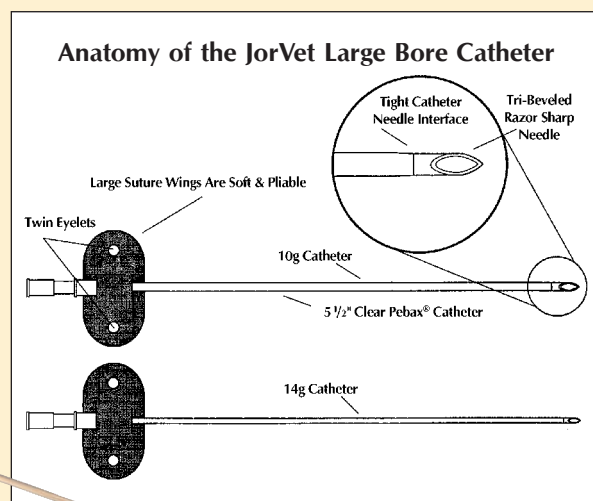

Most traditional jugular catheters are teflon. They can create a thrombosis and crack if left in place for over 48 hours. The development of new materials allows large-bore catheters that can safely be left in-dwelling for up to 10 days. The **JorVet Extended Use Catheter** softens at body temperature. Many of the common catheter-related problems, such as phlebitis, can be minimized with these catheters.

- 14g and 16g polyurethane catheter over needle
- Non-thrombogenic and non-cracking
- Can be safely left in the vein for up to 10 days
- This same catheter is used in 24 out of 27 U.S. veterinary teaching hospitals
- Suture wings with holes or suture groove attachment
- Sterile

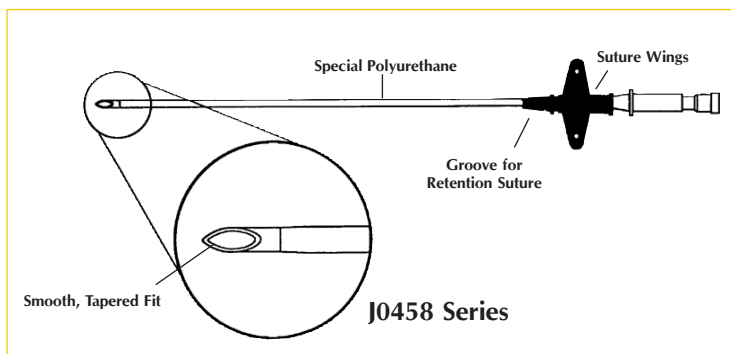

**J0458a Extended Use Catheter.** Complete. 14g x 5.25".

**J0458b Extended Use Catheter.** Complete. 16g x 5.25".

**J0458c Foal/Calf Extended Use Catheter.** Complete. 16g x 3.00".

**J0458d Foal/Calf Extended Use Catheter.** Complete. 14g x 3.50".

**J0458e Extended Use IV Catheter.** Complete. 12g x 5.25"

**Vet Pro Infusion Pump.** “They say great things come in small packages” The Vet Pro 2000 is specifically designed to be extremely small but very powerful for today’s veterinary clinic.

This amazing little pump is lightweight, weighing less than 1 lb and about the size of a soda. The Vet Pro 2000 can operate on A/C power while charging or remove from charging base to operate on battery alone. This will allow for greater portability making this pump the very last pump you will have to or want to buy!

- User-friendly Numeric Keypad, Full Text LCD
- Li-Ion Battery — 15 hrs on one charge
- Lightweight only 360 gm <1 Lb
- Adjustable pressure settings
- All types of IV solutions
- New Piston Pumping Technology for reliability and accuracy +/- 5%

**Specifications:**

- 1 year limited warranty
- Flow rate: 0.1 ml/hr to 1200 ml/hr
- Types of infusions: Continuous, intermittent, TPN +/- 5%
- Accuracy: + / - 5%
- KVO Rate: 0.1 ml/hr to 5 ml/hr (user adjustable)
- Air Sensor: Ultrasonic
- Power supply: 110 — 240 VAC, 50/60 Hz, 20W
- Battery: Li-Ion 7.2 V, 1800 mA Rechargeable
- Battery Charging automatic when latched in A/C charger
- Charge Time: 4–6 hours for total charge
- Alarms: End Program, Low/End battery, Air inline, Door Open, Lock keypad
- Mounting: IV Pole mounting or Cage Clip
- Dimensions: 6<sup>3</sup>/<sub>4</sub>" L x 3<sup>1</sup>/<sub>2</sub>" W x 3<sup>3</sup>/<sub>8</sub>" D
- Weight: 360 gm (11.6 oz) including mount/charging base

**J1097 Abbott Vet Pro 2000**  
**J1097b Baxter IV set model**

Please specify Abbott or Baxter IV set model  
 Made In Israel Serviced in U.S.

**Vet Pro Twin Infusion Pump.** “If you think one is good, two is always better.” The Vet Twin enables you to have the ability to run dual lines at one time on the same pump! Why tangle with multiple pumps when you can use just ONE!

Vet Twin has all the same specifications as the Vet Pro but is set up for running dual IV sets. This pump will operate off of A/C power while charging battery or on battery for approximately 7.5 hours with a charge time of only 4 to 6 hours. Extremely small—6<sup>3</sup>/<sub>4</sub>"L x 4<sup>1</sup>/<sub>2</sub>"H x 3"D and lightweight—less than 1 Lb—will take care of all clinic needs in one shot!

**J1098 Abbott Dual Infusion pump**  
**J1098b Baxter IV set model**

Please specify Abbott or Baxter IV sets  
 Made In Israel

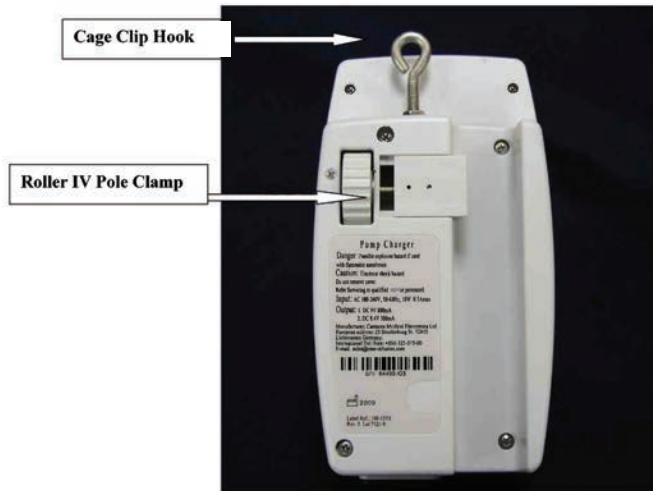
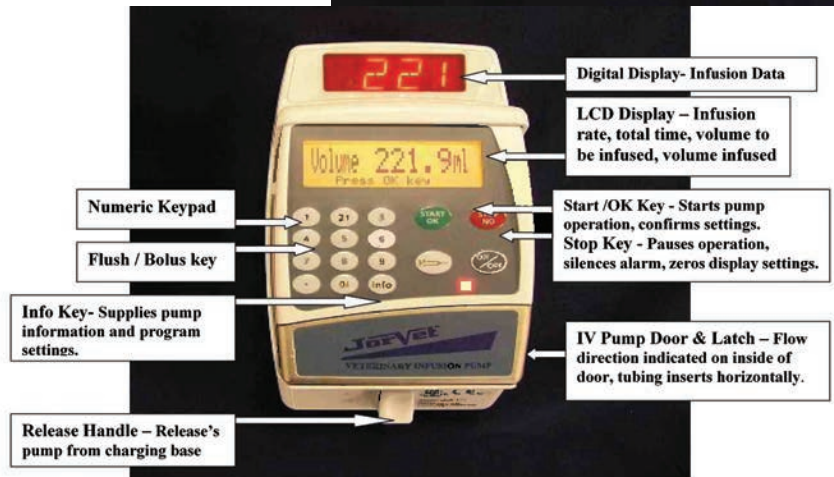

**J1098**



**Winged Infusion Set.** These popular sets are commonly known as Butterfly® style IV sets. They are great for short term IV infusion or in difficult venipunctures.

Tubing with female luer fitting is 12" long. A 3/4" razor sharp needle is attached to flexible colored coded wings. Priced very inexpensive. Sterile. 100/box.

- J0454a Infusion Set.** 19g. Yellow.
- J0454b Infusion Set.** 21g. Green.
- J0454c Infusion Set.** 23g. Blue.
- J0454d Infusion Set.** 25g. Orange.

© Trademark of Abbott Laboratories

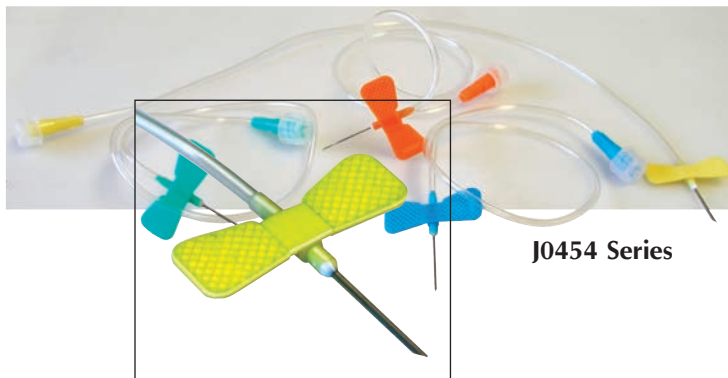

**J0454 Series**

**J1060mn** **The new lightweight infusion pump** will work with all quality IV sets, but works best with Baxter or Abbott IV sets are used. Standard IV set (10, 15, 20, or 60 drops/ml), or micro drip IV set (60 drops/ml) with 3.4-3.5 mm tubing). Limited two-year warranty.

*Specifications:*

- **No drip detector needed.**
- **Easy to navigate settings menu**
- **Pumping mechanism:** Peristaltic finger pump
- **Applicable IV set:** 10, 15, 20 and 60 d/ml (with outer diameter 3.4 ~ 4.5mm) Can program up to 20 different brands of IV sets.
- **Flow rate setting range:** 1.0 -1200 ml hr (can set in 0.1ml increments up to 100 ml)
- **Infusion rate options:** Set at ml/hr, drops/ minute or volume/time
- **Flow rate accuracy:** +/- 5% (after calibration)
- **Volume limit:** 1-9999 mls
- **KVO:** 1 ml
- **Occlusion pressure:** 40 ~ 140 KPa, 8 sensitivity setting
- **Purge rate:** 600 ml/hr
- **Audio and visual alarms:** Air-in-line, Door open, Upstream occlusion, Downstream occlusion, Infusion finished, No operation, Bottom empty, Battery low, Pump error, Motor reverse, AC power lost.
- **Self check during start up and during infusion.**
- **Power source:** AC100V ~ 240V, 50Hz/60Hz
- **Internal battery:** Rechargeable Ni-MH battery, DC12V,2000mAh
- **Display:** Blue LCD with high brightness
- **Dimensions:** 150mm x 150mm x 235mm
- **Weight:** 2.3 Kg



**J1096** **Automated Syringe Pump.** A syringe pump allows precise delivery of medications over a chosen time. It can be used as an infusion pump for very small patients. Works best with B/D or Terumo syringes.

*Main Features:*

- Recognizes syringe size automatically
- Easy to use! Just enter the flow rate and the dosage desired in mls/hr and you're done.
- Large LED display
- Can be attached to IV pole or lay on flat surface.

*Specifications:*

- Flow rate increments: 0.2 to 650 ml/hr
- Syringe size: 2ml to 50ml
- Size: 38mm (deep) x 55mm (high)
- Weight: 400gm or < 1 lb or 14.5 oz including battery
- Battery: 7.4V Li-ion 1800 mh recharge
- Limited 1-year warranty
- Languages: English, Italian, Spanish, Dutch & German
- Made in Israel, repaired in U.S.
- 0.05-10ml per hour in 0.01 increments
- 10-650ml per hour in 1 ml increments
- Weight with pole mount : 1.5lbs
- Weight without pole mount: 0.9lbs



**J1096**

**Veterinary Jugular Catheter.** Braun and JorVet have joined to provide a new range of jugular catheters. These have been used extensively on the human medical side for years.

- Polyurethane catheter material, very well tolerated by patients for extended periods
- Insertion stylet
- "Short" catheter with needle is inserted first, then removed after placement of longer catheter
- Long catheter is placed through the "short" catheter
- Clear protective sleeve protects catheter during placement
- Complete directions included

- J4286340 Veterinary Jugular Catheter.** 18g needle x 20g catheter x 32cm length
- J4153359 Veterinary Jugular Catheter.** 14g needle x 16g catheter x 32cm length
- J4152557 Veterinary Jugular Catheter.** 16g needle x 18g catheter x 45cm length

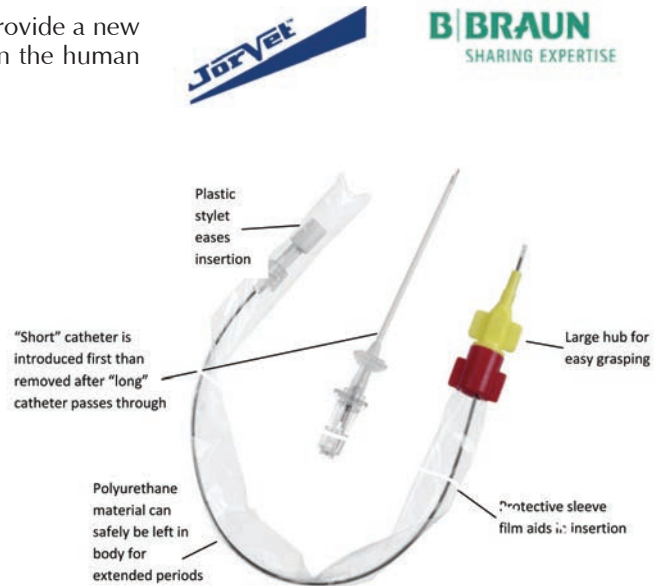

**Vet Cath® Jugular or large vein catheter.** JorVet developed this new IV catheter to replace the popular but no longer available Venocath. It is designed for jugular or large vein placement in critical care cases from cats to calves.

Vet Cath® was designed with these features and benefits in mind:

- Ease of placement with minimal components
- Adjustable catheter length: can be trimmed if so desired
- Inexpensive especially compared to central lines
- Biofriendly materials for reduced phlebitis
- Midterm use of several days
- 3 sizes for the variety of patient sizes

**Vet Cath®**

- 8"(20cm) polyurethane catheter with graduated in cm with tapered point
- Remove insertion needle first then stylet by backing out of the catheter.
- Catheter stylet maintains catheter rigidity as it is passed through the needle and can aid in passing down the vein
- No need for clear protective film over catheter as rigid stylet with proximal hubs to finger grip makes passage easy
- Clam shell connector slides on proximal end of the catheter then is closed to grip catheter.
- Clear hub gives visualization of blood
- protection end cap also provided

**Placement overview**

- Measure outside the patient for optimum catheter length in vein. 8"(20cm) total length
- Clip and sterile prep area
- Place insertion needle in vein
- Partially thread catheters through insertion needle into vein while still in stylet
- Remove insertion needle by backing out over catheter
- Trim catheter to desired length if deemed necessary
- Slide clam shell over the catheter end and close in place.
- Use suture wings to suture in place or tape as desired with approximately 1"(2.5cm) of catheter left protruding from the skin

	Needle Size	Catheter Size	Length
<b>J1305</b>	18g	20g	20cm
<b>J1305a</b>	16g	18g	20cm
<b>J1305b</b>	14g	16g	20cm

**Clamshell for catheter tubing.** Thread catheter tubing through clam shell and it securely locks/clamps down on tubing. Female luerlock with removable cap. Allows adjustable length on tubing and trim then clamp.

- J1305d1** 18g tubing clamshell
- J1305d2** 20g tubing clamshell

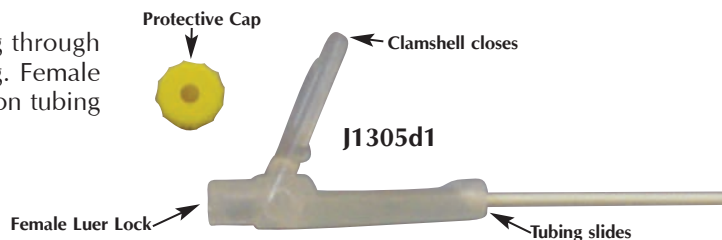

**IV Fluid Warmer.** The use of room temperature (70°F) IV fluids on patients either in shock or susceptible to hypothermia should be avoided. Ideally, IV fluids should be administered as close to body temperature as possible to all patients for better therapeutic results. The JorVet IV fluid warmer is placed over a short 8" segment of a standard IV line, where it will safely warm passing fluids to 100°F. It should be placed within 18" of the patient.

This small lightweight unit uses a 110V AC adaptor. The current is stepped down to low voltage 12V DC for safety. Just plug in and turn on. No adjustments or calibrations needed.

- Adjustable hanging strap supports weight of unit on whatever the IV fluid bag is supported by.
- Separate cartridge or tube extensions not needed
- Inexpensive
- Flow rate up to 12ml/min.
- Wipe clean between cases
- USA made with 1-year warranty

**J0900 IV Fluid Warmer**  
**J0900d1 AC Adapter.** 90-day warranty.

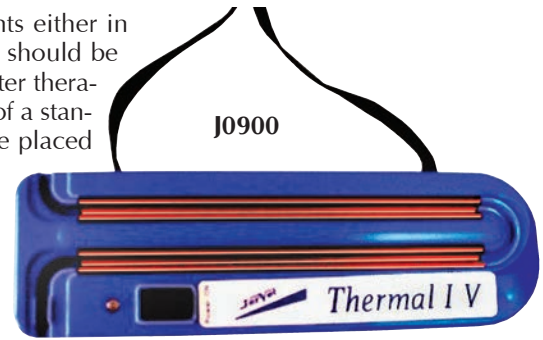

**Bullpen IV Fluid Warmer Station.** Administering IV fluids close to body temperature has become increasingly viewed as a valuable therapeutic modality. Veterinary patients, either small in size or in possible hypovolemic shock, benefit greatly from receiving warm IV fluids (~100°F) versus room temperature (70°F) fluids. However, maintaining a ready supply of warmed fluids has been difficult.

The JorVet Bullpen is an IV fluid warming station that maintains unopened IV fluid bags at a ready to use temperature of 100°F. Up to 4 one-liter bags of IV fluids can be warmed and kept ready to use. IV fluids placed on the Bullpen's top can be left for an extended period of time (weeks), warm and ready for the next patient. Simple to use, with no maintenance required, the Bullpen can be left on 24/7. The Bullpen works in conjunction with the JorVet Thermal IV (J0900). A one-liter bag takes 2 1/2 hours to reach 90°F and 6 hours to reach and maintain 100°F.

One-year warranty. 110V 60 Hz.  
 16"W x 3 1/8"H x 13 7/8"D. 5.3 lbs.

**J0900b Bullpen IV Fluid Warmer Station.**  
**J0900d1 AC Adapter.** 90-day warranty.

**Central Venous Catheter Kits.** These long-term catheters have been the standard of critical care in human medicine for many years. The catheters are placed in the jugular vein using a technique called Seldinger. It uses a guide wire system.

- Non-reactive polyurethane catheter: can be left in place for extended use i.e. 3-4 weeks.
- Single, double or even triple lumen catheters of various lengths: allows administration concurrently of different IV medications

**Kit consists of:**

- Polyurethane radiopaque catheter with clamp
- Introducer needle
- Vessel dilator
- Guide wire
- Injection caps
- 5ml syringe
- Illustrated directions

**J1040 Central Venous Catheter Kit**

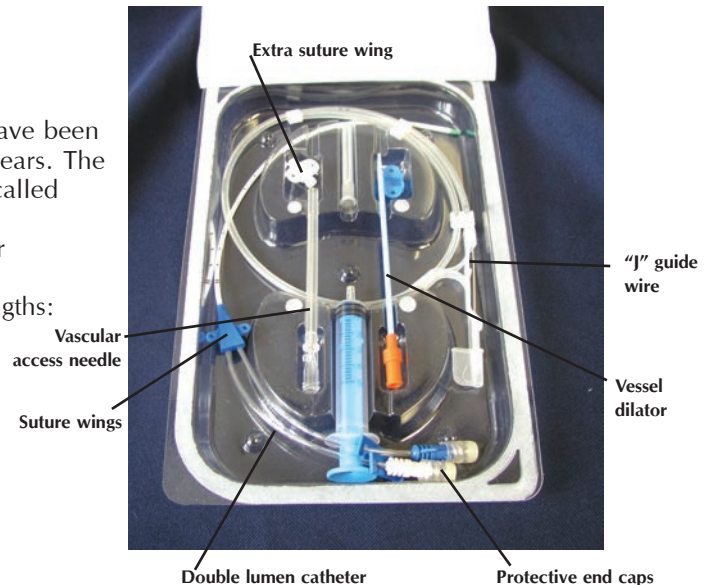

**Sizes available:**

Single lumen	Catheter Sizes	Priming Volume(ml)
<b>J1040</b>	20g x 8cm (3 1/4")	0.20
<b>J1040a</b>	20g x 13cm (5 1/4")	0.20
<b>J1041</b>	18g x 8cm (3 1/4")	0.20
<b>J1041a</b>	18g x 13cm (5 1/4")	0.20
<b>J1042</b>	16g x 13cm (5 1/4")	0.32
<b>J1042a</b>	16g x 20cm (8")	0.38

Double lumen	Catheter Sizes	Priming Volume(ml)
<b>J1044</b>	4fr X 13cm (5 1/4")	0.18/0.17
<b>J1044a</b>	7fr X 20cm (8")	0.49/0.36
<b>J1044b</b>	7fr X 30cm (12")	0.60/0.37
Triple lumen	Catheter Sizes	Priming Volume(ml)
<b>J1045</b>	5.5fr X 13cm (5 1/4")	0.22/0.19/0.19
<b>J1045a</b>	7fr X 20cm (8")	0.39/0.29/0.26
<b>J1045b</b>	7fr X 30cm (12")	0.49/0.39/0.39



**Ancillary Items for Long Term Catheter or Tubing Placement.**

Useful for other procedures in addition to venous placement such as chest tubes or long Foley catheters

**Guidewires in Dispensers.** Spring metal flexible guidewires in a plastic dispensing coil. One end has a soft flexible “J” tip and the other end has a soft straight tip. Sterile.

	Dimensions	Compatible Catheter/Tubing Size
<b>J1279</b>	0.018" x 45cm	4fr and 5fr
<b>J1279a</b>	0.032" x 45cm	16g
<b>J1279b</b>	0.035" x 60cm	14g or 7fr

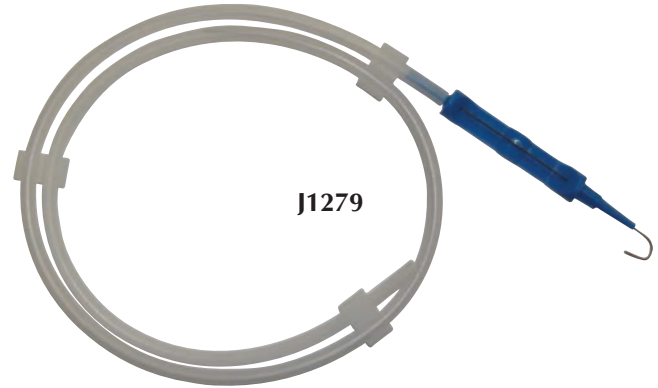

**Vessel Dilators.** Used to bluntly pass down vein or body cavity to open up for passage of catheter or tubing. 4" length. Sterile.

<b>J1297</b>	4fr
<b>J1297a</b>	5fr
<b>J1297b</b>	6fr
<b>J1297c</b>	7fr



J1297 series

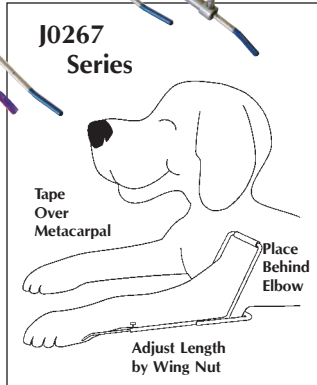

**Cochran IV Splint.** Small animal veterinarians often are confronted with the problem of administering a continuous or uninterrupted IV drip to an unattended patient. The cephalic vein is easily occluded when an animal is in a sternal position with the elbow in flexion. The patented Cochran IV Splint is the first product that allows the animal to lie comfortably and still ensure a continuous IV flow. This IV splint will enable the practitioner to extend the patency and longevity of an IV catheter and administer a more continuous and even flow of IV fluids to critically ill patients.

- J0267a Splint.** Small. For felines and canines <10 lbs.
- J0267b Splint.** Medium. 20 lbs. canine.
- J0267c Splint.** Large. 40 lbs. canine.
- J0267d Splint.** X-Large. 60 lbs. and above.
- J0267s Splints.** Set of 4.

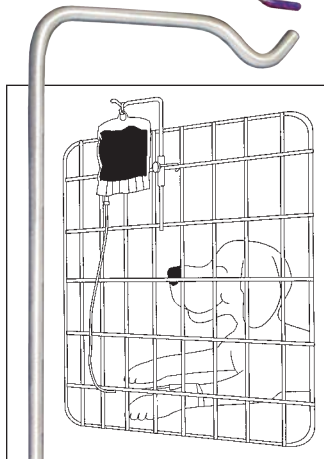

**J0461**

**J0461 JorVet IV Cage Mounted Bag Holder.** The simple design allows easy and quick location change. Spring-loaded lock holds and clamps securely onto horizontal cage bar. Stainless steel  $\frac{3}{8}$ " solid rod looks attractive and professional.

- Fits any standard size cage door from all manufacturers
- Economical, costs considerably less than other holders
- Cleans and disinfects easily after use
- 4"W x18"H. 0.65 lbs.



**J0461a**

**J0461a SpaceSaver Cage Mount** will save space and permanently mount on all styles of cages with the ease of dismounting for more flexibility. You can permanently mount and safely secure infusion pumps and IV bags. IV hanger included.

- J0050a** **Intravenous Needle and Case.** Special cutting point makes insertion into vein very easy. With case. 3" shaft. 2.5mm (~14g).
- J0050b** **Intravenous Needle,** with case. 3" shaft. 3mm (~11g).
- J0063** **Simplex IV Bell.** High quality latex. 4' tubing. (needle included)
- J0027r** **IV Infusion Pump** for rapid infusion of large volumes of IV fluids, the rubber bulb pump infuses air into any bottle by needle insertion. Air pressure forces fluid out much quicker than simple gravity. For equine and bovine use. Dark orange.

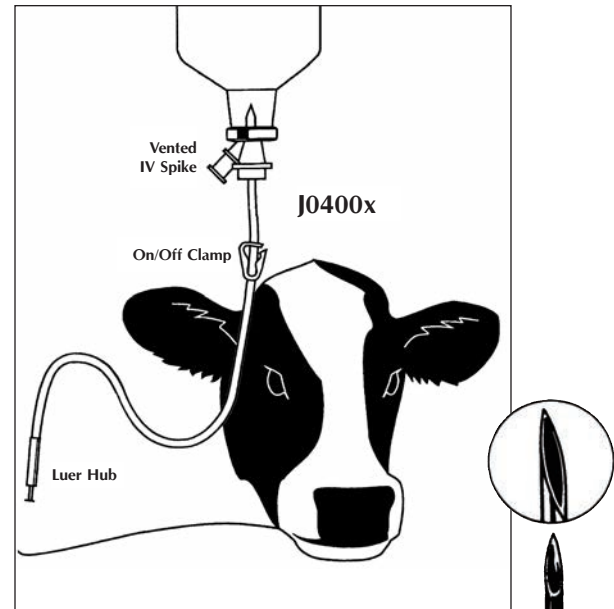
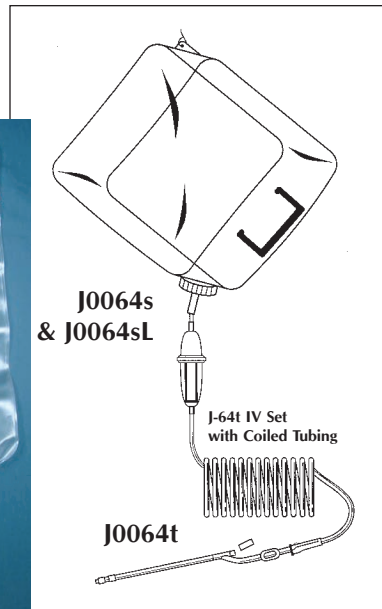
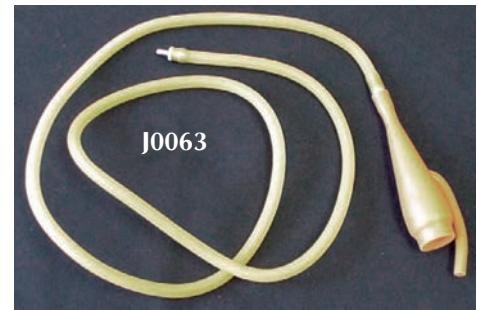
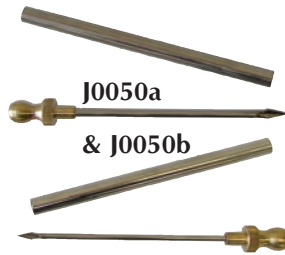

**Large Volume IV Solution Bag.** New collapsible bag with large-size drip chamber for use with concentrates of lactated ringers. For rapid infusion of large volumes.

- J0400p** 3-Liter Bag.
- J0400q** 6-Liter Bag.

**Complete Infusion Set** that can handle the large volume of fluid therapy necessary in large animals. The Willoughby style tubing stretches to 10', allowing movement to a restrained or stalled animal. It has a collapsible container made for easy storage in a mobile unit. Non-sterile.

- J0064s** **Infusion Set.** 5-Liter.
- J0064sL** **Infusion Set.** 20-Liter.
- J0064b** **Collapsible Plastic Bag** only. 5-Liter.
- J0064bL** **Collapsible Plastic Bag** only. 20-Liter.
- J0064t** **Administration Set.** Drip chamber and tubing included. 20 drops/ml.

**J0400x** **Large Bore IV Set.** The JorVet large-bore IV set is a simple design for the rapid administration of solutions to large animals. Twice the diameter of conventional IV sets, the large bore increases the flow rate by a factor of 16 over standard human IV sets. Sterile. 72" tubing.

**Bleeding Needle.** Stainless steel.

- J0199a** **Needle.** 16g x 3". 12/pk.
- J0199b** **Needle.** 15g x 3". 12/pk.
- J0199c** **Needle.** 14g x 3". 12/pk.





**Large Bore IV Administration Set.** Larger animals such as horses and cattle require tremendous amounts of IV fluids in a short period of time. The standard smaller human IV sets cannot meet the large IV fluid demands of a critically ill 1,200lb horse.

The JorVet Large Bore IV Set can increase the flow rate up to almost 20-liters per hour, a necessary volume in severe colic or equine critical care emergency.

**Poiseville's Law of Fluids:** The volume of a fluid through a tube varies as the fourth power of the diameter of the tubing.  $V=D^4$  other things being equal.

The diameter of the large bore IV set is two times that of a conventional IV set. This translates into 16 times the flow rate.

**J0400L Large IV Set.** Complete. Sterile.

**J0400Le Large Bore Twin Spike IV Set.** An economical way to deliver the high volumes needed in large animal clinical cases such as colic.

- Twin spikes to hook up to dual bags
- Large bore tubing for high flow rate
- Longer length of 250cm (8 feet)
- Luer lock for secure fitting
- 15µm particle filter
- Made by Braun for quality

Large bore coiled tubing costs a premium and this new set offers an inexpensive alternative.

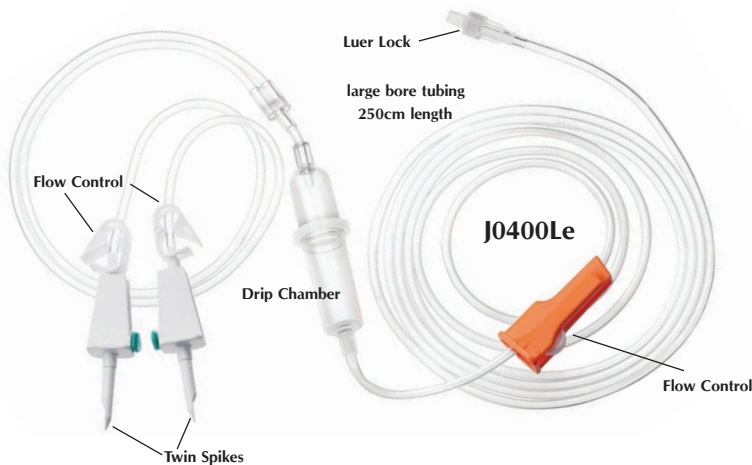
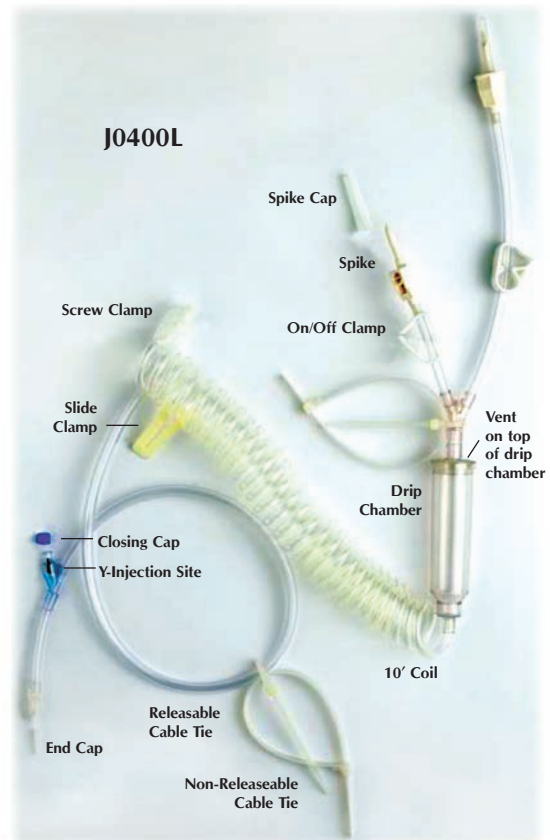

**Accessories.**

**J0400t Large Bore Transfer Set.** Useful for hooking up additional fluid bags. Double-ended spike and tubing (12") with on/off pinch clamp. Sterile.

**J0400e Large Bore Extension Set.** Tubing (30") with screw-type female luers and male spin luer lock. Sterile.

**J0462 JorVet 3-Way Stopcock.** Male spin luer lock and two female luer lock fittings. Sterile.

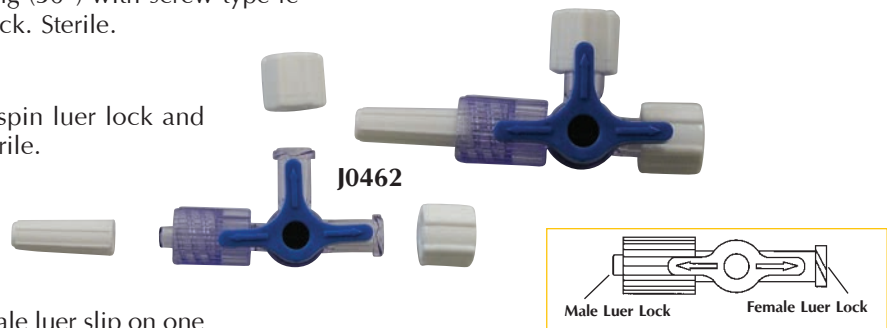

**J0462s Discifix One-Way Stopcock.** Male luer slip on one end. Female luer lock on the other end with flow control valve. Sterile.



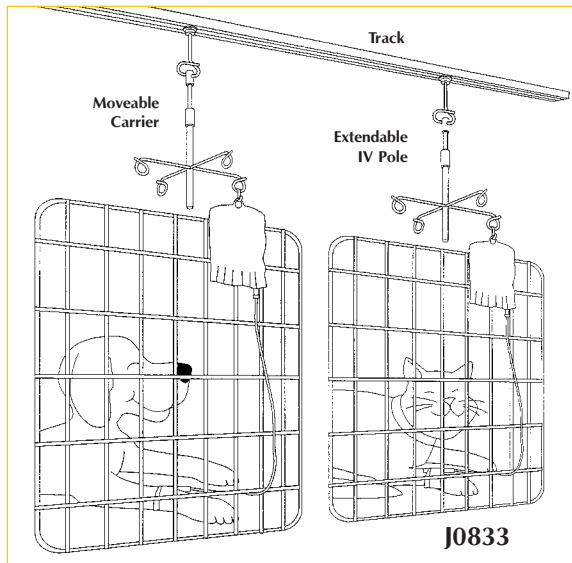

**IV Holder with Track System.** This simple system puts a moveable IV bag holder on a track that is suspended from the ceiling. The IV holder can be positioned above cages, treatment area, or the surgery table. When not in use, it is simply retracted upward and pushed off to the side.

- Track can be installed into any type of ceiling.
- Lightweight aluminum track comes in any length sections; can be trimmed with hacksaw if needed.
- Four-wheel carrier runs in track. It is locked into position by turning it 360°. A pendant ring is attached to carrier.
- IV holder attached to carrier. It has 4 ram's horns at 90° angle. They each can hold an IV bag. It extends and retracts at the push of a button.
- Oval sections of track are also available.

**J0833 Complete IV Holder System** (track not included):

- IV holder for four bags (**J-833h**)
- Four-wheel carrier with ring (**J-833c**)
- Two end caps for track (**J-833e**)

**J0833t Foot Track Sections.** Order track by number of feet desired. 8' maximum for a single piece; splicing needed for longer lengths.

**J0833s Splice Plate.** Use to join sections of track over 8' in length.

**J0833h 4-Ring IV Holder.**

**J0833c Four-Wheel Carrier.**

**0-833p Stationary Body and Plate with Ring.** (hardware not included)  
Suggest attaching **J-833h**, IV holder.

**J0833e End Cap** only.

J0833c



J0833p



For Ceiling Heights to 8'6"

4 1/2"

11" ≈ Standard Extension

12 1/2" ≈

5"

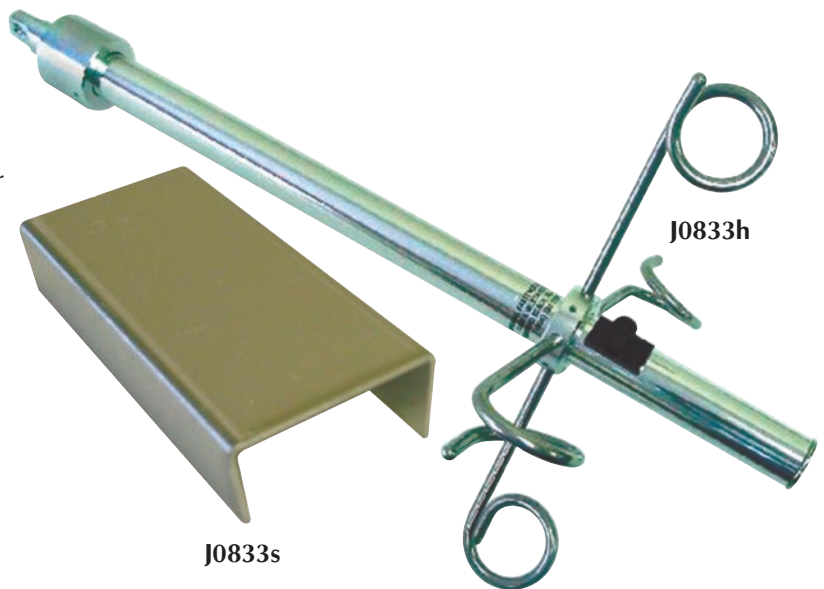
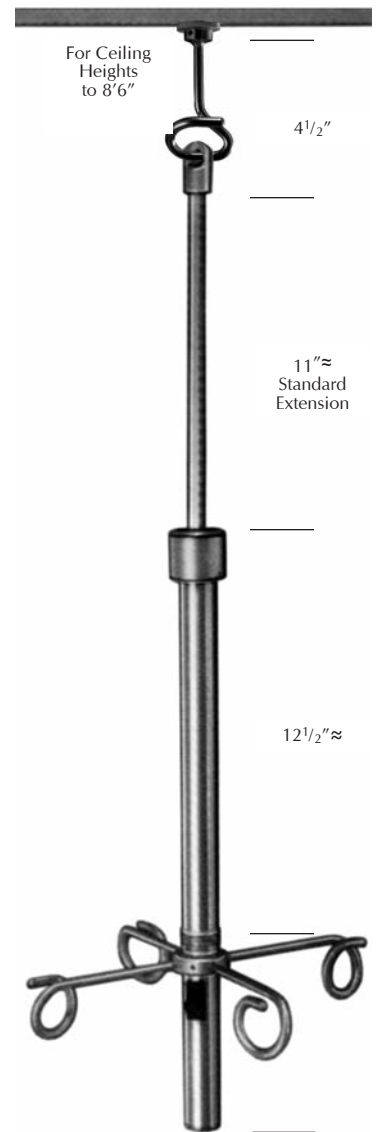

J0833s

J0833h

A wide range of **Blood Transfusion Products** allows for all species to be recipients of blood transfusion medicine. Canines tolerate standard human transfusion products. Feline patients require much smaller 50–150ml bags. Equine patients need 1–4 liter bags to do the job adequately.

Blood component therapy is an expanding field. Plasma and concentrated RBCs can be separated, and specific therapeutic modalities can be implemented. The addition of transfer bags and dry collection bags make this an easy procedure.

**J0520 Single Collection Unit Prefilled CPDA-1.** CPDA-1 is the anticoagulant of choice in human blood banking. After collection, stored blood will have a 35-day shelf life. Bag comes with 16g diamond point non-detachable needle plus double spike ports. 450ml. 29" tubing. Contains 63ml of CPD-1.

**J-520q Single Collection Unit Prefilled CPDA-1.** 250ml. Contains 35ml of CPDA-1.

*NOTE: Now available in foil packaging for longer shelf life before use.*

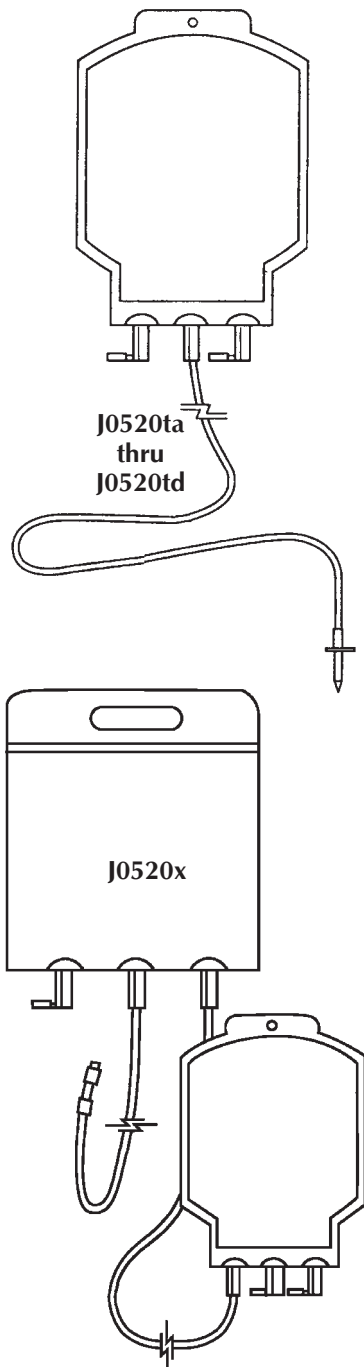

**Transfer Bag.** Designed to receive blood components or plasma, transfer bags have 2 spike entry ports and a single transfer spike with tubing. Sterile. Do not contain anticoagulants.

**J0520ta Transfer Bag.** 150ml.

**J0520tb Transfer Bag.** 300ml.

**J0520tc Transfer Bag.** 600ml. Single head with dual transfer spikes. 36" tubing.

**J0520td Transfer Bag.** 1000ml. Single head with dual transfer spikes.

**Dry Blood Collection Bag.** Provide your own anticoagulant for the use of these blood bags. Two spike ports with donor tubing with "Y" injection port. Includes directions for use.

**J0520a Collection Bag.** 50–150ml. Best product for feline use. (needle not included)

**J0520b Collection Bag.** 300ml.

**J0520c Collection Bag.** 600ml.

**J0520d Collection Bag.** 1000ml.

12g needle for large animal use.

**J0520f Collection Bag.** 4-Liter. 12g needle.

**Blood Collection with Attached Transfer Bag.** Considered a closed system, this is useful for separating blood components. Collect blood from a suitable donor in the 450ml bag containing the CPDA#1 anticoagulant via standard blood collection techniques. The blood is separated into plasma and red blood cells portions refrigerated upright either via standing gravity or blood centrifuge. Store the bag with the transfer tube on the bottom since concentrated RBCs are heavier.

After separation gently snap the white plastic stopper into half to open the transfer channel which allows concentrated RBC to drain into the attached transfer bag. After completion of transfer the connecting tubing is cut and sealed.

Benefits include the ability to freeze the plasma portion for an extended period. Concentrated RBC's can be given to an anemic patient in a much smaller volume.

**J0520x Blood Collection with Attached Transfer Bag.** 29" tubing.

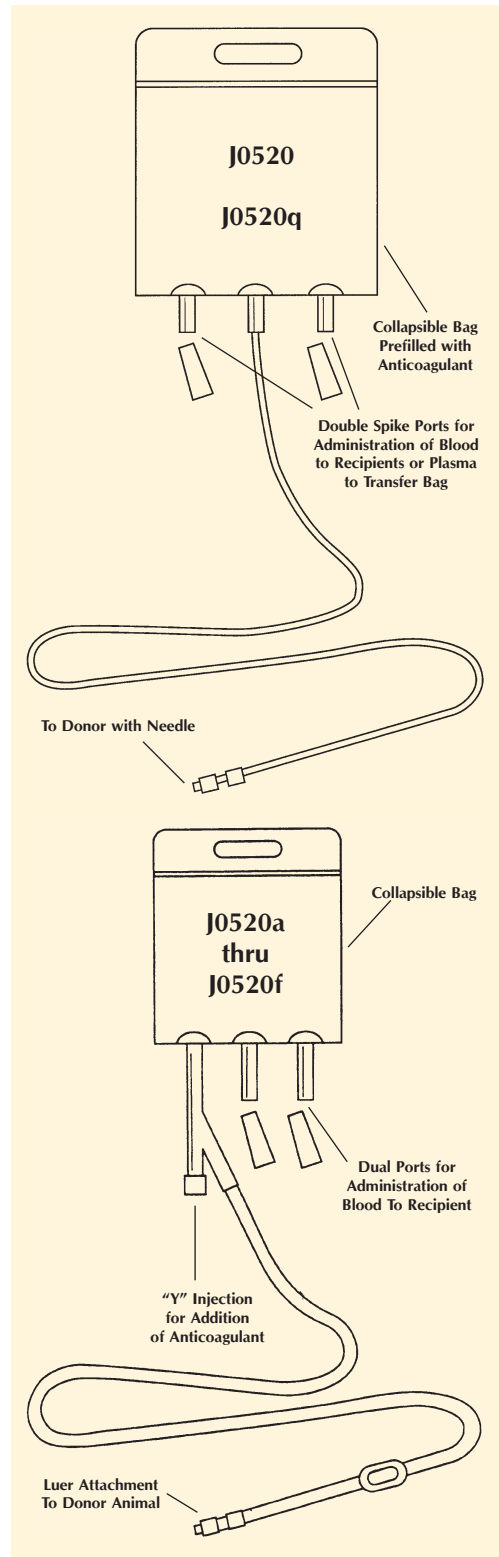



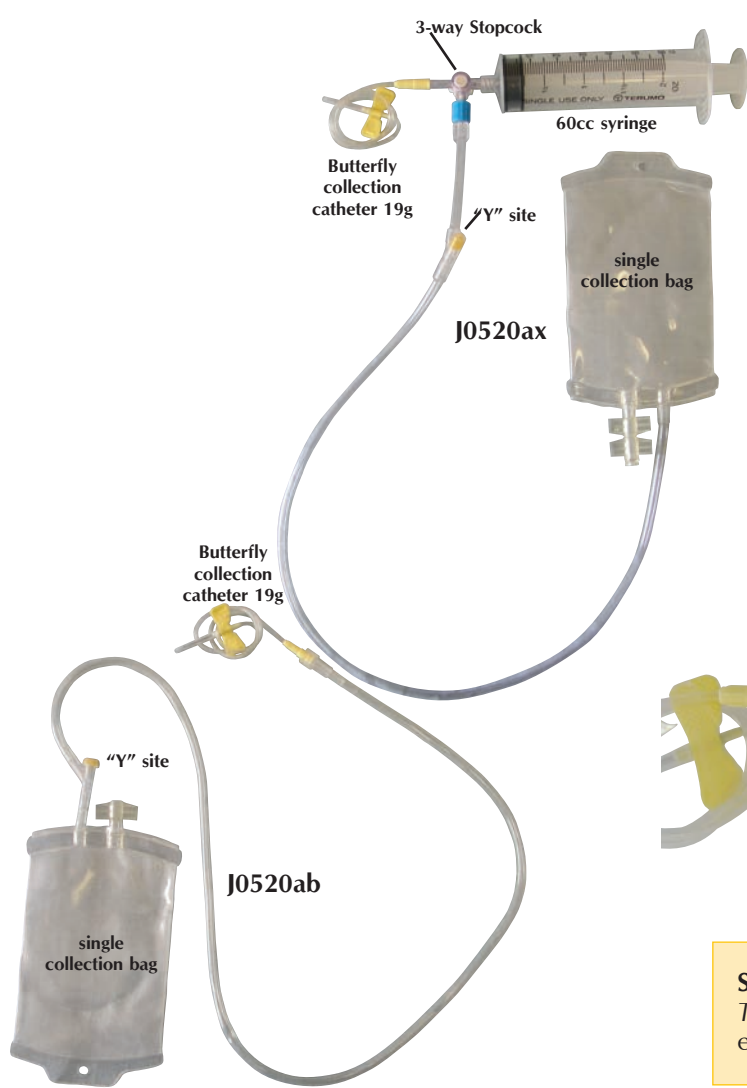

**Small Blood Bag Collection Sets.** The addition of these blood collection sets allows for easier and proper feline and small animal blood collection. They are a complete closed system that will get better blood component results, i.e., packed RBC or plasma. The bags are provided dry and anticoagulant (**J0522**) will need to be added. The sets come in two basic formats: a set with 19g butterfly needle or a 60cc syringe with a 3-way stop cock.

**J0520ab Small blood bag collection set.**

- 100 dry (blood) collection bag
- 19g butterfly needle with tubing
- complete directions

**J0520ax Small blood bag collection set.**

- 100 ml dry blood collection bag
- 60cc syringe
- 3-way stopcock
- 19g butterfly needle with tubing
- complete directions



**Species.** An informative literature piece, *Overview of Transfusion Medicine* is available for feline, canine, and equine species at [www.JorVet.com](http://www.JorVet.com).



**J1318c Braun Empty IV Container.** 150ml capacity. Sterile Partial Additive Bag (PAB)

**NEW**

- Latex free
- PVC free
- DEHP free
- Dual ports: Add port and port for administration set
- Hanging loop on top

Rigid port allows safer and easier addition of prescribed drugs.

No over wraps: ready to use.

**Partially filled bags with 0.9% saline.**

**J1318a 25ml fill in a 100ml capacity bag**

**J1318b 100ml fill in a 150ml capacity bag**

**Anticoagulants.** It is important to note how anticoagulants vary in their intended use.

**Sodium Citrate.** A very familiar product to veterinarians. It has no RBC preservative, and thus should be used for blood therapy that will be done with a short 24 to 48-hour period of time. If only the plasma component is to be used it will also work well for that purpose.

**ACD-A = Acid Citrate Dextrose Type A.** This anticoagulant has dextrose, which acts as energy source for the RBCs. The use of ACD-A can give RBCs a shelf life of about 28 days when stored at 4° C.

**CPDA #1:** The preferred solution for longer-term storage of blood products. Average shelf life can be 35 days.

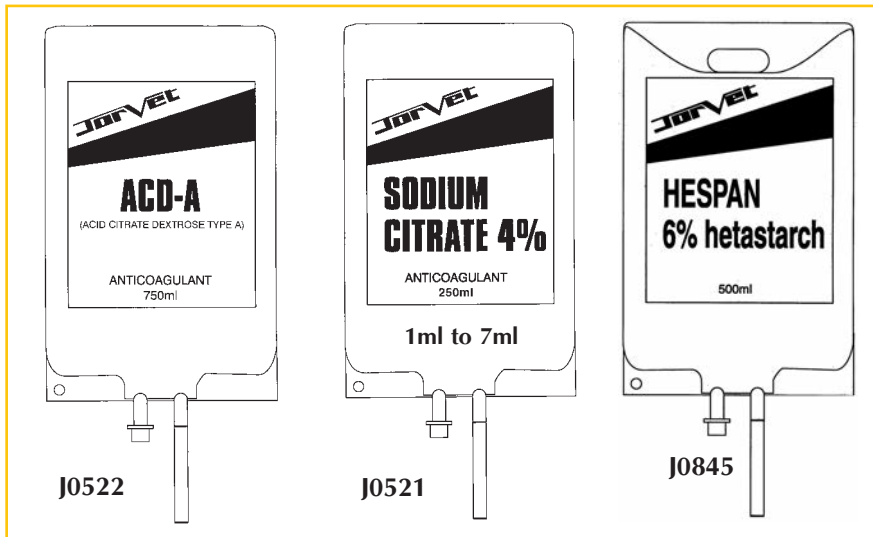

- J0522**    **ACD-A (Acid Citrate Dextrose).** 750ml. This anticoagulant has dextrose to provide energy to the RBCs. This will give the stored blood a shelf life of about 28 days. Dilute 1ml of solution to 9ml blood.
- J0522a**    **CPDA #1. Anticoagulant 500ml.** This is the preferred solution for blood bank storage. Multi dose collapsible bag.
- J0521**    **Sodium Citrate 4% Anticoagulant.** 250ml. Great for use in equine plasma therapy or small animal short-term whole blood therapy. Dilute 1ml to 7–9ml of blood
- J0845**    **Hespan (Hetastarch).** 500ml. A sterile solution of 6 percent hetastarch in 0.9 percent saline. Hetastarch is colloid solution that acts as a plasma expander in cases of hypovolemic shock.



J0522a

- J1081x**    **IV Bag Spike with Smart Site Injection Port.** This product allows an IV bag to be spiked then fluids can be added or withdrawn via the needle free female luerlock. The needle free valve also prevents any leakage after IV bag is spiked. Sterile.
- J1081y**    **IV Bag Spike with Check Valve and Smart Site Injection Port.** This product allows an IV bag to be spiked then fluids withdrawn only. The check valve prevents the ADDITION of any fluid. It has a needle free Smart-Site female luerlock injector port. This also prevents any leakage after the IV bag is spiked. Sterile.



J1081x



J1081y

**J0065** **Blood Transfusion and Infusion Set** with filter and plastic drip chamber. Roller clamp is flow-regulating. Sterile. Disposable. 20 drops/ml.



**J1133** **Droplet™ Blood Collection Tray.** This handy Tray allows easy access and storage of every thing necessary for blood collection

- Sturdy lightweight ABS plastic frame measures 429mm (17") x 265mm (10.6") x 172mm (6.9")
- Side supply drawer
- 4 side pockets on both ends
- Soft rubber grip on handle that ratchets out of the way
- Included 36 place test tube rack
- Remove tray for easy cleaning
- Extra deep compartment for sharps container (not included)
- Tray with 1 extra insert and a 36-place 16mm test tube rack. (test tubes not included)



**Surgicutt Bleeding Time Devices**

**J0522s** A simple automatic incision making handheld device for determining bleeding time, i.e. buccal mucosal bleeding time. White color. 1mm deep x 5mm long blade for large dogs. Single use product.

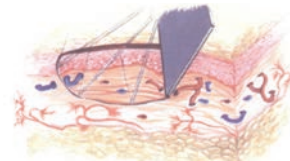

**J0522j** Junior Pediatric size with 1mm deep x 3.5mm long narrow blade. Pink color. For smaller dogs and cats. Measures 1" x 1" x 3/8". Single use product

**J0522p** Surgicutt Blotting Paper. Pkg/10 (not pictured).



**J0522h** **Hemo Nate Blood Filter.** Removes small volumes of particulate debris through an 18 micron stainless steel filter which allows viable blood product to pass through with ease. Especially useful with "syringe" method of transfusion used in feline medicine. Attaches to any male fitting. Syringe not included.



**J0522t** **Hemo-Tap.** This spike has a filter and can be used on any blood bag or transfer component bag. Used for adding blood compatible medications or syringe access.

**J1081** **0.2 Micron Disc Filter.** This filter has a female luer lock and male luer lock fitting. Green X 22mm width. Sterile. Packaged singles. **Syringe not included.**



Also see IRAP Accessory Kit on page 273.



**Bone Biopsies.** This range of biopsy instruments allows one of the following samples to be taken.

- Cortical bone biopsy
- Bone marrow aspirate
- Bone marrow biopsy

The tip shape will vary according to the task.

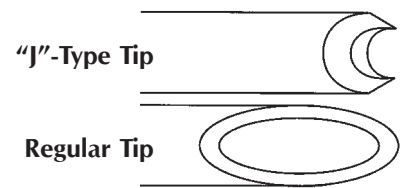

**J0116c Osty Core Bone/Biopsy Needle.** For taking core samples of bone (i.e. suspected osteosarcoma). Sterile. Not autoclavable. 16g x 7.5cm (3").

*NOTE: Not for bone marrow aspirates.*

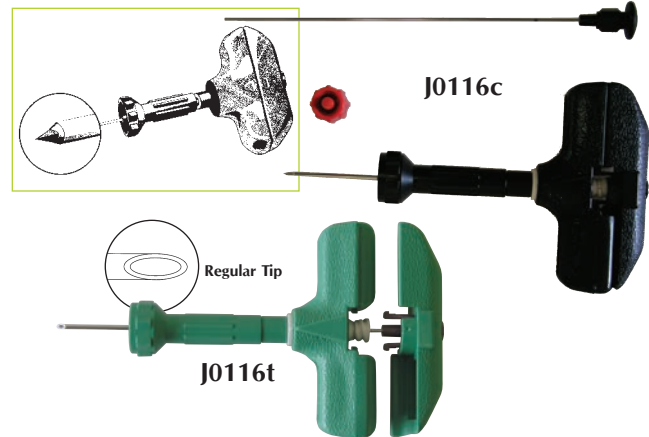

**J0116t JorVet Bone Marrow Needle,** 16g regular tip. Large hand grip for increased torque. Adjustable depth stop from  $\frac{3}{8}$ " to  $1\frac{7}{8}$ " shaft. Luer lock syringe attachment. Similar to Jamshidi style. Also can be used for intraosseous fluid administration. Sterile. Green. Not autoclavable.

**Biopsy/Aspiration Bone Marrow Needles.** These bone marrow needles allow for an actual biopsy versus the aspiration other needles provide. A special reamer is included to allow retrieval of actual tissue sample. Notice the difference in tip design, a double-side diamond. Not autoclavable. Sterile.

**J0116k Bone Marrow Needle,** biopsy/aspiration. 8g x 4".

**J0116m Bone Marrow Needle,** biopsy/aspiration. 11g x 4".

**J0116s JorVet Bone Marrow Needle.** 13g x 4". (reamer not included)

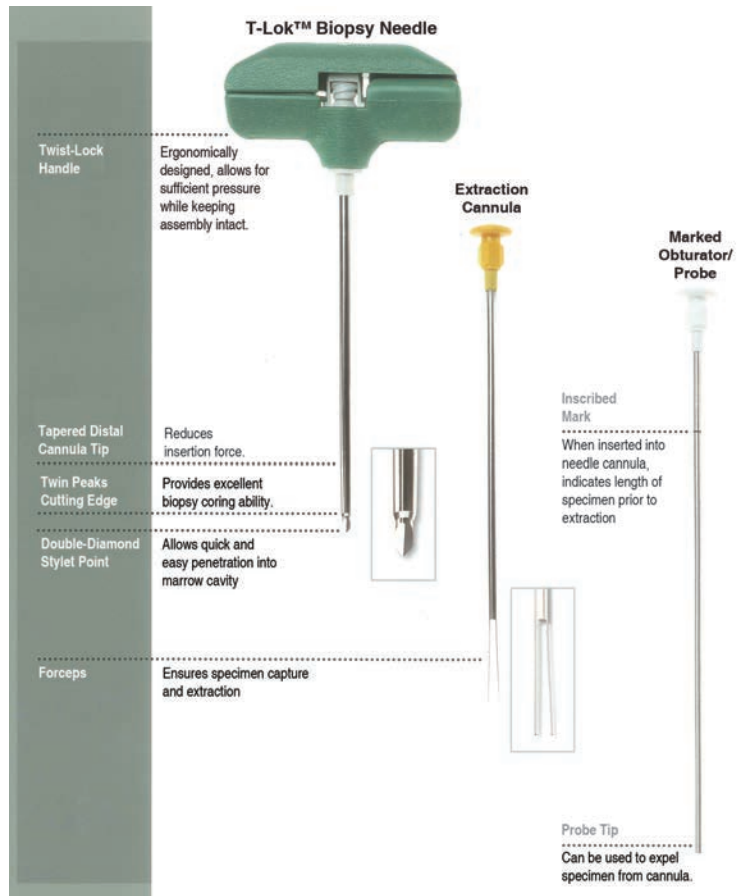
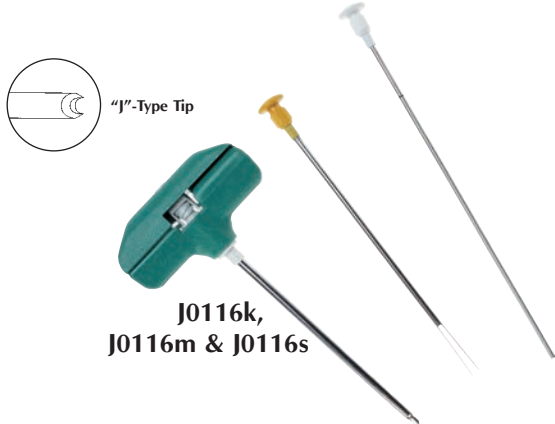

**J0229 Michele Trephine.** Perfect instrument for a bone biopsy or drilling a small hole into the sinus. 6mm head. German-made. Stainless steel. Autoclavable.  $7\frac{1}{2}$ ".



**J0116r Rosenthal Needle.** For use in bone marrow biopsy. Containing large spool luer lock hub, sharp pointed cannula and fitted stylet with matched bevel point. Autoclavable.

**J0116ra Needle.** 18g x 1".

**J0116rb Needle.** 16g x  $1\frac{5}{16}$ ".



**Soft Tissue Biopsy Needles.** An expanded range of both biopsy needle types and sizes offer the veterinarian the most comprehensive biopsy needle selection available. Any tissue from any species should be able to be procured with this line.

The biopsy needles are usually typed according to the sample desired. The true cut style, super core spring load, and traditional Vin Silverman are all specimen notch type needles. Whereas the Franseen, Chiba, and spinal needles are aspiration or cutting core type needles. The smaller gauge sizes allow for fine needle aspirates.

The use of ultrasound guided biopsy needles has made more accurate biopsies possible. These require special echogenic tips along with marked graduations to access proper depth and location.

**JorVet Soft Tissue Biopsy Needle.** Perfect for obtaining accurate and cleanly cut soft tissue biopsies. This precision cutting helps preserve cellular architecture, thus making diagnosis more definitive. Compares favorably with Travenol's Tru Cut® biopsy needle. Sterile. Not autoclavable.

**Biopsy Needle.** Long enough to reach any biopsy site. 1mm x 20mm specimen chamber.

- J0118 Biopsy Needle.** 14g x 4½" L shaft.
- J0118a Biopsy Needle.** 14g x 15cm (6¾").
- J0118b Biopsy Needle.** 16g x 10cm (4").
- J0118c Biopsy Needle.** 16g x 16cm (6¾").
- J0118d Biopsy Needle.** 18g x 10cm (4").

**J0116vs Vin Silverman Biopsy Needle.** This is the Franklin modification. Filled ends. Stainless steel. Autoclavable. 14g x 2¾".

**J0116u Equine Uterine Biopsy Instrument.** 24½" long.

**J0117 Soft Tissue Biopsy Alligator Forceps.** 2mm diameter, shaft is 10cm. Biopsy jaws 2 mm x 3.6 mm. Can pass down otoscope cone.

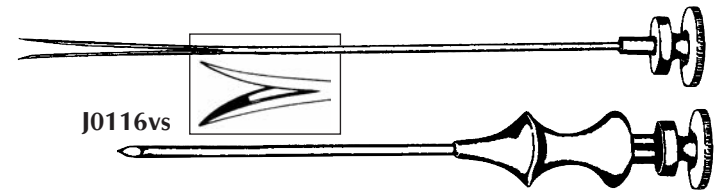
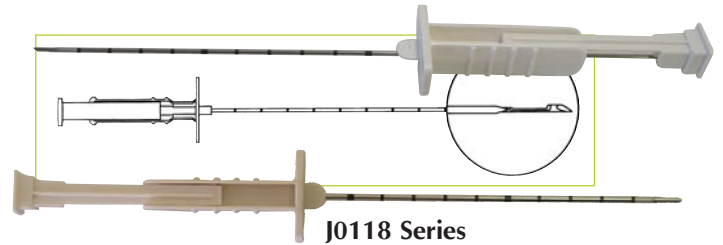

**Super Core Biopsy Needle.** Sterile. Not autoclavable.

Features:

- Spring activated single handle operation
- Ideal lightweight design
- Echogenic tip for ultrasound visualization
- 20mm specimen notch
- Marked with cm graduations

- J0528 Biopsy Needle.** 14g x 9cm.
- J0528a Biopsy Needle.** 16g x 9cm.
- J0528b Biopsy Needle.** 16g x 15cm.
- J0528c Biopsy Needle.** 18g x 9cm.

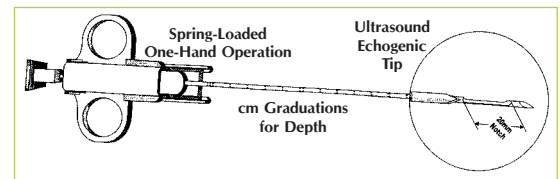

**Tru-Core II Biopsy Needle.** The next generation of soft tissue biopsy instruments. The Tru-Core II is widely used in human medicine because:

- Ease of use
- Better, more representative samples
- Uses 1, 2, 3 process clearly labeled on the instrument
- Echogenic tip for use with an ultrasound
- Sterile. Not autoclavable.

- J0528f Biopsy Needle.** 14g x 10cm
- J0528g Biopsy Needle.** 14g x 16cm
- J0528h Biopsy Needle.** 16g x 10cm
- J0528j Biopsy Needle.** 16g x 16cm
- J0528k Biopsy Needle.** 18g x 10cm



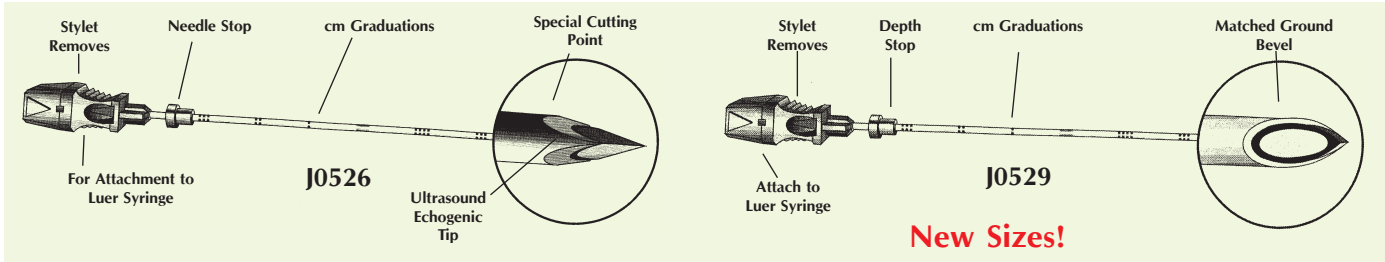

**Franseen Style Needle.** Used to obtain core biopsy specimens for histology and impression smears. Attaches to standard syringe for aspiration. Cannula point design suitable for cutting difficult lesions. Also available in echogenic (ultrasound) tips. Sterile. Not autoclavable.

**Unmarked Needle.**  
**J0526 Unmarked Needle.** 18g x 9cm.

**Marked Graduations with Echogenic Tip.**  
**J0526ec Marked Needle.** 20g x 15cm.

**Spinal Needle. Quincke style point.** JorVet now offers a new range of spinal tap needles, affordable and in popular sizes. General purpose aspiration biopsies and drainage procedures. Matched ground bevel eliminates possibility of tissue coring. Attaches to standard luer fitting. Available with echogenic enhanced tip (ultra-sound). Not autoclavable. Sterile.

- Unmarked Needle.**
- J0529h Unmarked Needle.** 22g x 3<sup>1</sup>/<sub>2</sub>"
  - J0529f Unmarked Needle.** 22g x 2<sup>1</sup>/<sub>2</sub>"
  - J0529g Unmarked Needle.** 20g x 3<sup>1</sup>/<sub>2</sub>"
  - J0529be Unmarked Needle.** 20g x 2<sup>1</sup>/<sub>2</sub>"
  - J0529c Unmarked Needle.** 20g x 6"
  - J0529j Unmarked Needle.** 18g x 3<sup>1</sup>/<sub>2</sub>"
  - J0529an Unmarked Needle.** 18g x 6"
  - J0529jn Unmarked Needle.** 18g x 3<sup>1</sup>/<sub>2</sub>"
  - J0529k Unmarked Needle.** 22g x 6"
  - J0529m Unmarked Needle.** 20g x 8"
  - J0529n Unmarked Needle.** 18g x 8"

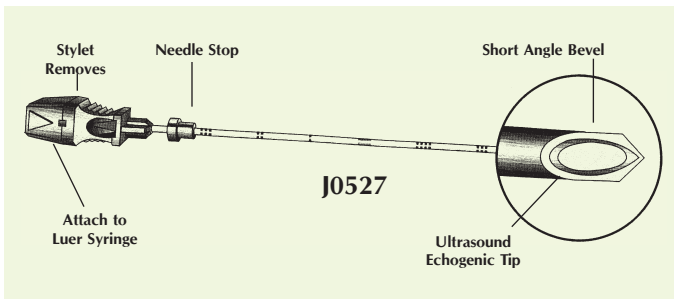

**Chiba Style Needle.** General purpose aspiration biopsy needle. Short bevel removes sample from controlled area. Attaches to standard syringe. Small sizes for fine needle aspirates. Echogenic enhanced tip (ultrasound) available. Sterile. Not autoclavable.

- Unmarked Needle.**
- J0527a Unmarked Needle.** 18g x 15cm.
  - J0527ab Unmarked Needle.** 18g x 20cm.
  - J0527d Unmarked Needle.** 22g x 9cm.
  - J0527e Unmarked Needle.** 22g x 15cm.

- Marked Graduations with Echogenic Tip.**
- J0527ea Marked Needle.** 18g x 15cm.
  - J0527ec Marked Needle.** 20g x 15cm.
  - J0527ed Marked Needle.** 22g x 9cm.

**J1111 Skin Scraping Spatula.** Highly recommended over scalpel blades because risk for injury is minimized. Double ended with one round flat end 50mm (L) x 8mm (W) and other end is tapered flat 45mm x 6.5mm. Mirror finish. Stainless steel wire with nickel plating.



**J1111**

- Marked Graduations with Echogenic Tip.**
- J0529eb Marked Needle.** 20g x 9cm (3<sup>3</sup>/<sub>4</sub>").
  - J0529ed Marked Needle.** 22g x 9cm (3<sup>3</sup>/<sub>4</sub>").

**Key's Skin Biopsy Punch.** Original round skin punches, knurled handle. Stainless steel. German-made. 4<sup>1</sup>/<sub>2</sub>" (12cm).

- J0163 Biopsy Punch.** 4mm head.
- J0163a Biopsy Punch.** 6mm head.
- J0163b Biopsy Punch.** 8mm head.



**J0163**

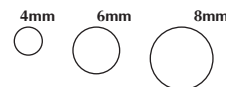

**Inexpensive Disposable Skin Biopsy Punch** with lightweight plastic handle. Sterile. 5/pk.

- J0163d4 Skin Biopsy Punch.** 4mm head.
- J0163d6 Skin Biopsy Punch.** 6mm head.
- J0163d8 Skin Biopsy Punch.** 8mm head.

Seamless Razor-Sharp Stainless Steel Blade      Ribbed Handle Offers Superior Control      Diameter Reading ID

J0163d4, J0163d6 & J0163d8

Hollow Handle Provides Easy Specimen Retrieval



**Bone Marrow Intraosseous Needle.** Intraosseous infusion is an excellent option when vascular access is difficult. Fluids and most IV drugs can be administered in this fashion. This method is mainly used in small animals and birds where blood vessels are small to begin with. The most common site of placement is the proximal femur. The point of entry for the canula is the trochanteric fossa. This method is for short time use and an IV catheter should be placed as soon as possible.

**J0116q Infusion Needle.** Not autoclavable. 18g x 3.5cm. Sterile.

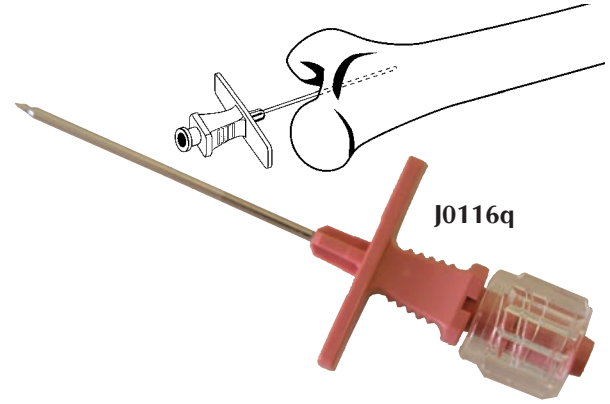

**J0645 Aspir-Gun, 12cc.** The Aspir-gun is combined with a 12cc syringe for precise fine needle aspiration biopsy. It can be used on any nodule that can be palpated or visualized with X-ray or ultrasound. It is especially useful for superficial lumps, allowing one hand to remain free to immobilize the lesion. Autoclavable. 6"L.

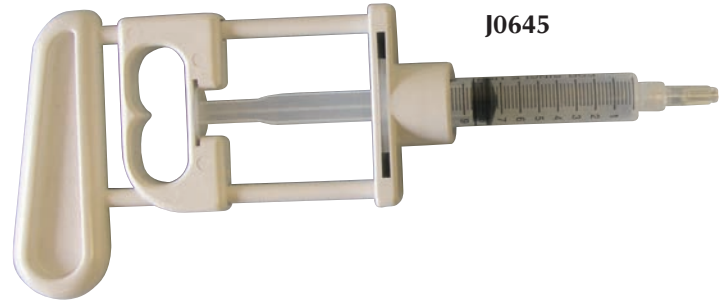

**J0116jw Jackson Uterine Biopsy Forceps.** This is the instrument of choice for equine uterine biopsy. Cutting area is 4mm x 28mm. Stainless steel. Shaft 60cm (23 1/2"L).

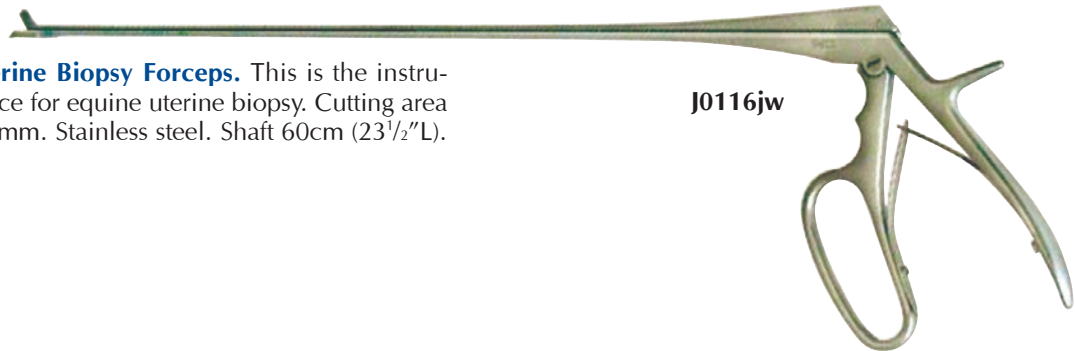

**J0116a Protection tube for uterine biopsy forceps.** This protective tube is passed through the cervix. A biopsy forceps is then passed through it to avoid any contamination on the biopsy sample. OD15mm x 40cm length



**Equine Uterine Flushing Catheter.** Large silicone catheter with large Foley inflatable balloon.

- Embryo transfer/collection
- Lateral eyes on open ended tip
- Inflatable balloon allows fluid retention in uterus when the catheter is passed beyond the cervix.
- Diameter: 33fr (8mm i.d. x 11mm o.d.)
- Includes two different adaptors
- **Reducing Connector (J0282d2)** to attach tubing
- **Barbed Connector (J0282d1)** with standard luer fitting

**J0282 Flushing Catheter.** 65cm L.  
**J0282L Flushing Catheter.** 135cm L.



**“Y” Flushing System.** “Y” connector, with 12” arms, gives in flow and out flow. Two shut-off clamps. Two different adaptors included.

**J0282y Complete “Y” System.** 95cm L.  
**J0282yL Complete “Y” System.** 165cm L.

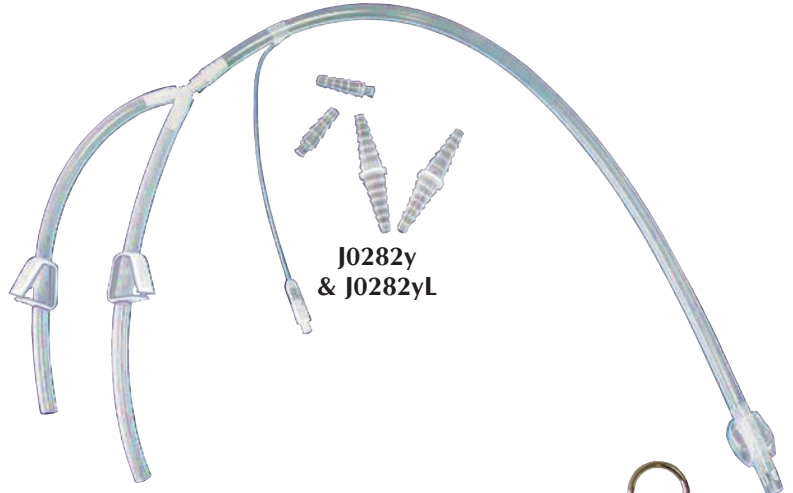

**J0090m Mare Urinary Catheter.** Metal with ring. 30cm x 8mm.

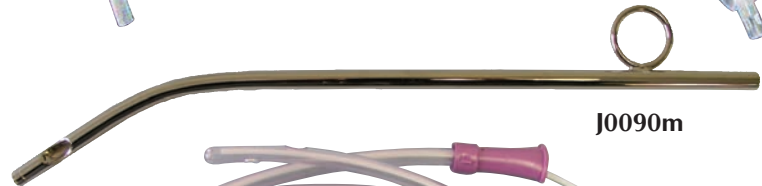

**J0090s Stallion Urinary Catheter.** Used in both geldings and stallions. Flexible plastic with plastic stylet. Sterile. 6.6mm x 137cm L.

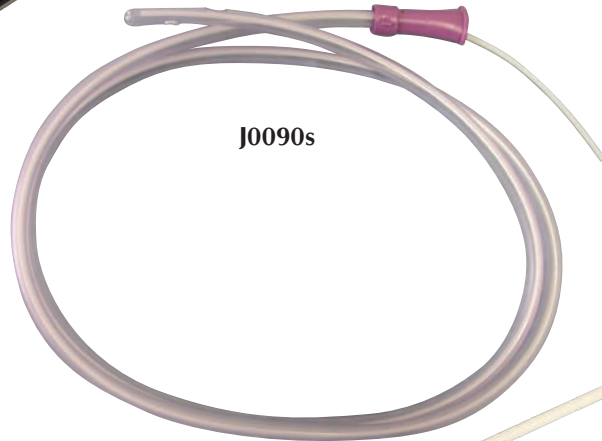

**J0090sm Mare Urinary Catheter.** Flexible plastic. Similar to **J0090s**, only shorter. 8.6 x 60cm L. (not pictured)

**J0198 Indwelling Uterine Infusor (IUI).** For continuous medication in the treatment of endometritis and other uterine conditions in bovine and equine. IUI is self-retaining and can be left in place until treatment is completed. Sterile. 30”L.

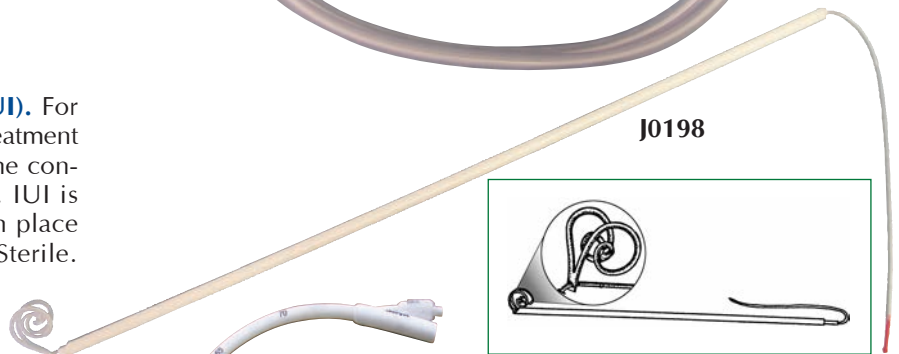

**Large Stallion Silicone Foley Catheter.**

**J0693sc Catheter.** 8.4mm (28fr) x 150cm L.  
**J0693sd Catheter.** 12fr x 150cm L.



**Equine Uterine Lavage Administration Kits.**

These large bore tubing kits are designed to connect large Foley catheters for large volume infusion and collection. The "Y" junction allows for fluid infusion and outflow for drainage or collection. Sterile.

**J1052 Long tubing with "Y" junction.** Extra long tubing 60" (5 ft) both inflow and outflow gives room for fluid administration and collection away from the animal. Attached large bore spikes for inflow at proximal end. The distal end has a barbed fitting for connection to Foley catheter.

**J1052a Short 6" inflow with female spin luer lock adapters.** This allows hookup to syringe or another administration set. There is a 30" outflow tube. Distal end has a barbed fitting for connection to Foley flushing catheter (J-282).

**J1052b Single line with 60" large bore tubing** with proximal spike and distal barbed fitting for attachment to Foley or large bore pipette (J-286).

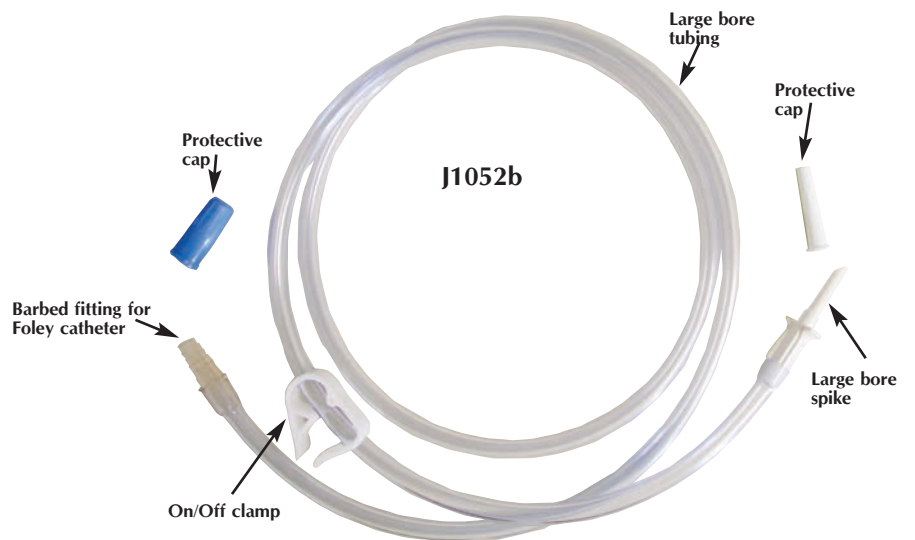
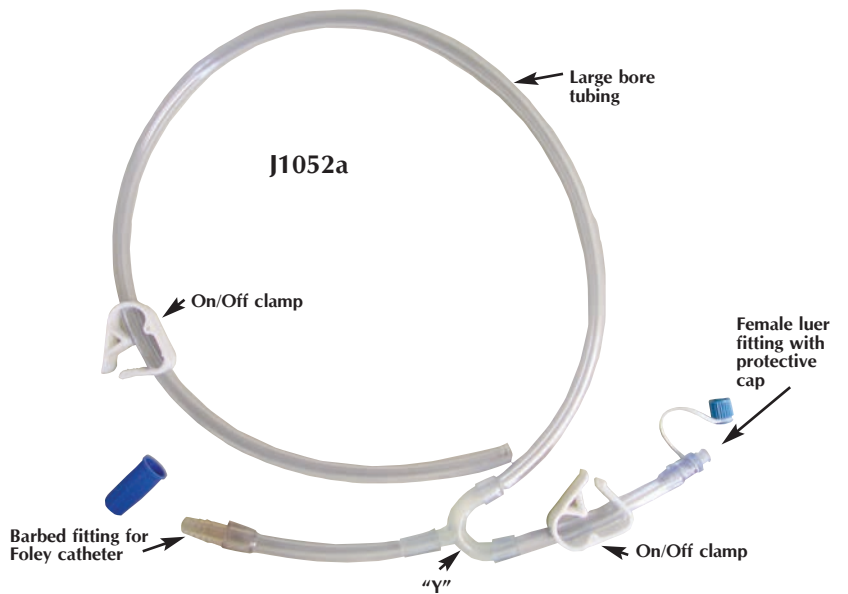
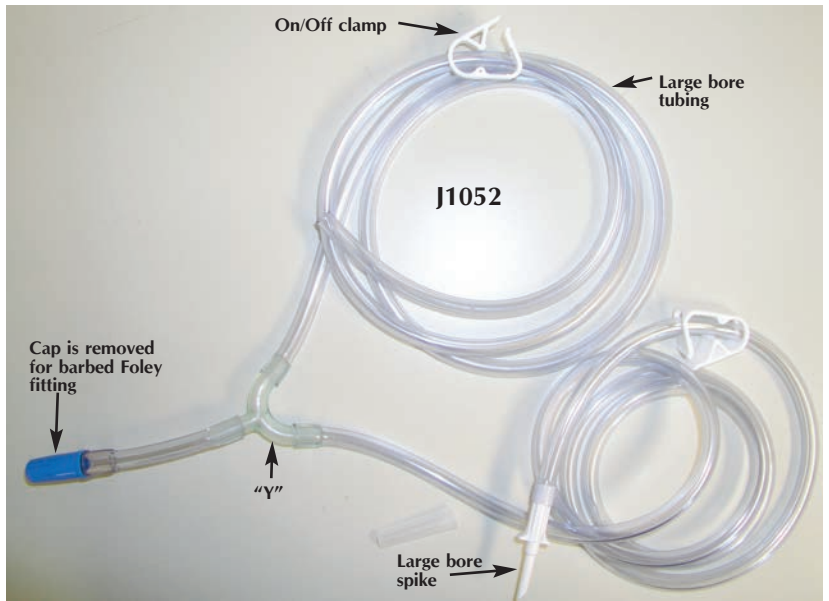



**NEW**

**BUSTER Jackson Cat Catheter.** The popular range of BUSTER Cat Catheters has been expanded to include new features, materials and sizes to cover the different needs in the feline patient.

- The luer lock adapter and the handle of the stylet are molded for premium quality.
- All catheters have rounded ends to avoid tissue damage
- Available with open end or bullet tip with lateral eyes
- Handles on luer adapter for better grip

#### **BUSTER Cat Catheters with side holes**

- Ideal for urine sample collection, urine retention and bladder lavage
- The catheter with stylet is softer than the catheter without stylet

**J0153ja** Cat Catheter with side holes, with stylet, 3fr. 10 x 130mm

**J0153jb** Cat Catheter with side holes, with stylet, 4fr. 1.3 x 130mm

#### **BUSTER Cat Catheter with open end hole**

- The catheter with open end hole is useful for loosening an obstruction by the pressure of the injection
- Extra rigid for easy introduction

**J0153m** Cat Catheter with open end hole, without stylet **NEW** 1.0 x 130mm, 3fr.

**J0153p** Cat Catheter with open end hole, without stylet **NEW** 1.3 x 130mm, 4fr.

#### **BUSTER Barium Cat Catheters, Extra Soft.**

- Soft pliable polyurethane material
- Ultra smooth surface slips right into place
- Can be safely left in situ for 3 days
- Only catheter that is radiopaque
- Closed end with two lateral eyes
- Stylet to aid placement
- Considerable savings over silicon and Teflon
- Outside suture ring holds catheter in position
- Sterile

**J0153ba** Barium Cat Catheter with side holes, with stylet **SOFT** 3fr (1mm) diameter x 130mm (5¼") length

**J0153bb** Barium Cat Catheter with side holes, with stylet **SOFT** 4fr (1.33mm) diameter x 130mm (5¼") length

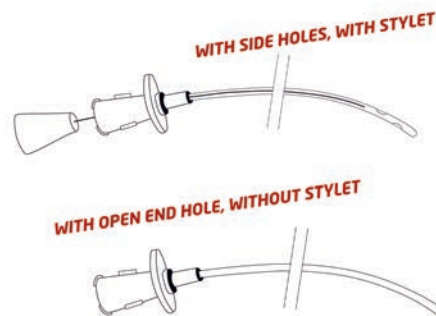

**THE COMPLETE RANGE OF BUSTER CAT CATHETERS**

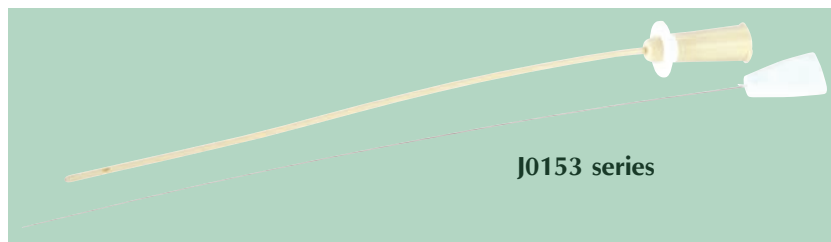



J0153w



J0153c



J0153d



J0153e

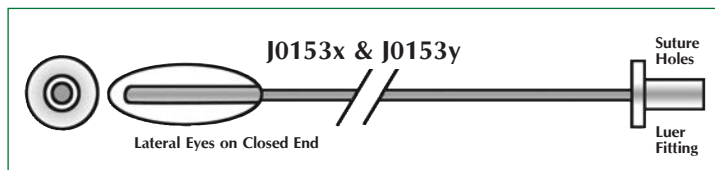

J0153



Barbed Fitting

Female Luer Lock

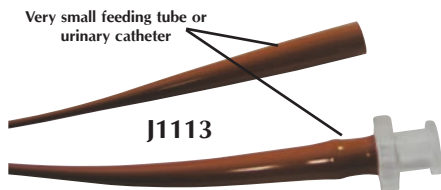

Very small feeding tube or urinary catheter

J1113

**J0153w Walpole's Solution.** This buffered solution will dissolve struvite plugs in feline urethral obstructions. Only 3–6cc of Walpole's will atraumatically dissolve the crystal plug. Conventional methods of retrograde flushing with saline cause urethral damage or ruptures and eventual stricture formation. Jackson cat catheters are recommended for best results when using Walpole's solution. 50cc bottle.

**J0153 Olive Tipped FUS Needle.** 21g olive tipped needles are perfect for flushing of the small male feline urethra in cases of obstructive FLUTD. The blunt tip prevents trauma to the sensitive urethral lining. Rather than forcing struvite plugs back into the bladder with saline, it is suggested that **J-153w** Walpole's solution is infused to dissolve away any crystal formation. Then a **J-153** series Jackson catheter is inserted to ensure urethral patency.

Luer mount fits any syringe. Stainless steel. Autoclavable. Individually packaged.

**J0153c FUS Needle.** 21g x 1/2".

**J0153d FUS Needle.** 21g x 1".

**J0153e FUS Needle.** 21g x 1 1/2".

**Tomcat Catheter** with luer fitting and suture holes is more bio-friendly. Plastic guide stylet included. Silicone.

**J0153x Catheter,** Closed End. 3.5fr x 5" (12cm).

**J0153y Catheter,** Open End. 3.5fr x 5" (12cm).

**J0153 Silicone Feline Urethrostomy Tube.** Silicone urethral catheter designed for use in initial feline urethrostomy procedures to prevent post-operative constriction or maintain urethral patency over time. Suture eyelets permit fixation to perineal area open end. Female luer fitting x 3" tube (can be trimmed to desired length) 0.073" ID x 0.125" OD sterile. Stylet.

**J1113 Cath Link Luerlock adapter.** Many urinary catheters and feeding tubes i.e. small red rubber tubes do not have the right connection to hook directly to a syringe. This luer lock adapter has a barbed fitting that fits tight in urinary catheter or feeding tubes. Sterile and autoclavable. (Use J0463c tethered cap in conjunction with this.)

**Canine Urinary Catheter** is constructed of a flexible transparent grade of nylon, producing firmness without rigidity. Female luer fitting. Closed end with lateral eye. Sterile.

- J0154xs Catheter.** 4fr x 50cm (20").
- J0154s Catheter.** 6fr x 50cm (20").
- J0154m Catheter.** 8fr x 50cm (20").
- J0154L Catheter.** 10fr x 50cm (20").

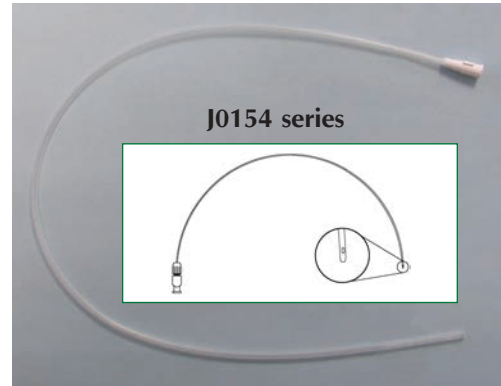

**Canine Urinary Catheter** with luer fitting and suture holes is more bio-friendly. Wire guide stylet included.

- J0090h Bitch Urinary Catheter.** Stainless steel. 10g heart-shaped finger rest. 10<sup>1</sup>/<sub>2</sub>"L.
- J0090c Canine Female Catheter.** Female luer fitting. Metal cleaning rod included. 18cm x 2.5mm.



**J1027 Urine collection bag.** Monitoring Urine output is an important aspect in treating critically ill renal patients. These collection bags are a polyethylene material, transparent on one side and white on the opposite side.

- 2000ml capacity with graduations
- Inflow connector is a tapered fitting that to a catheter (i.e. Foley) for a secure leak proof fit.
- Tubing is 11/32" X 50" cm length
- Universal double hook: can hang on cage
- Needle free sampling port
- Anti Reflux drip chamber: minimizes the risk of infection
- Additional clip can attach tubing to patients hair or fur
- Sterile fluid pathway

**J1027 Closed urinary drainage bag**

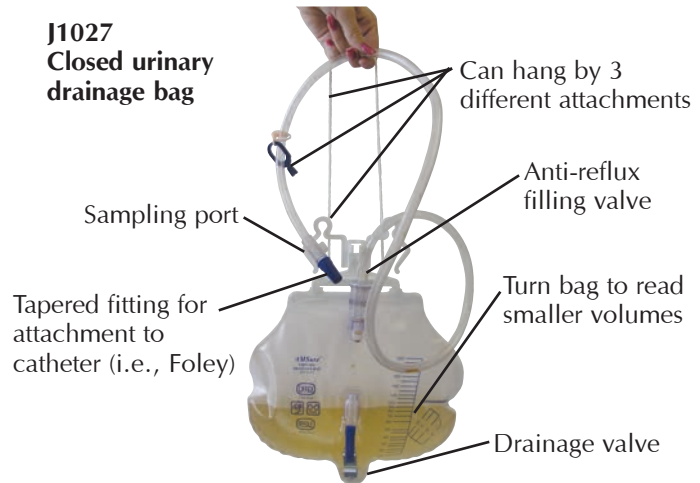

**J1027a Urine collection bag,** smaller version of **J-1027** bag.

- 600ml capacity
- Anti reflux drain
- Bottom drains through twist open/close valve
- Two straps: one on top and one on bottom
- Top drain is tiered to fit catheter i.e. Foley
- Sterile fluid pathway

**J1027a**

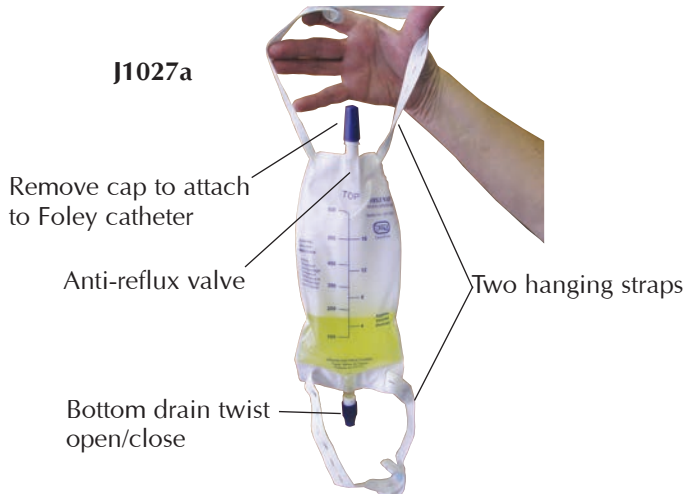



# KatKath™

*Be kind to your patients*

**KatKath™ TomCat Urinary Catheter.** Easy placement. Flexible for maximum comfort. Thin walled-larger bore lumen. Great longitudinal strength. Rounded atraumatic open-ended tip.

**More flexible/Low coefficient of friction.** The catheter is made from a unique non-reactive material which has similar properties to Telfon® but is more flexible. More flexibility allows greater comfort.

**Crush Resistant.** The KatKath™ is almost impossible to crush and is also highly resistant to kinking. This allows placement without the use of a stylet. (Useful if flushing is required during the act of placement.)

**Well Tolerated.** The KatKath™ may be left in place for hours or days, dependant on individual needs, and is extremely well tolerated by even the most difficult patients.

**Great Longitudinal Strength.** The KatKath's increased flexibility does not diminish its ability in the effective treatment of blocked cats due to its great longitudinal strength and will not concertina even when encountering gross resistance.

**Rotating Suture Collar.** The KatKath™ has a rotating suture collar—to allow natural rotation while in situ. This also lowers the tension on sutures.

- J1203** 3.5fr OD. 11cm long with Luer lock
- J1203a** 3.5fr OD. 14cm long with Luer lock
- J1203b** 3.5fr OD. 18cm adjustable Hub



Rotating suture collar

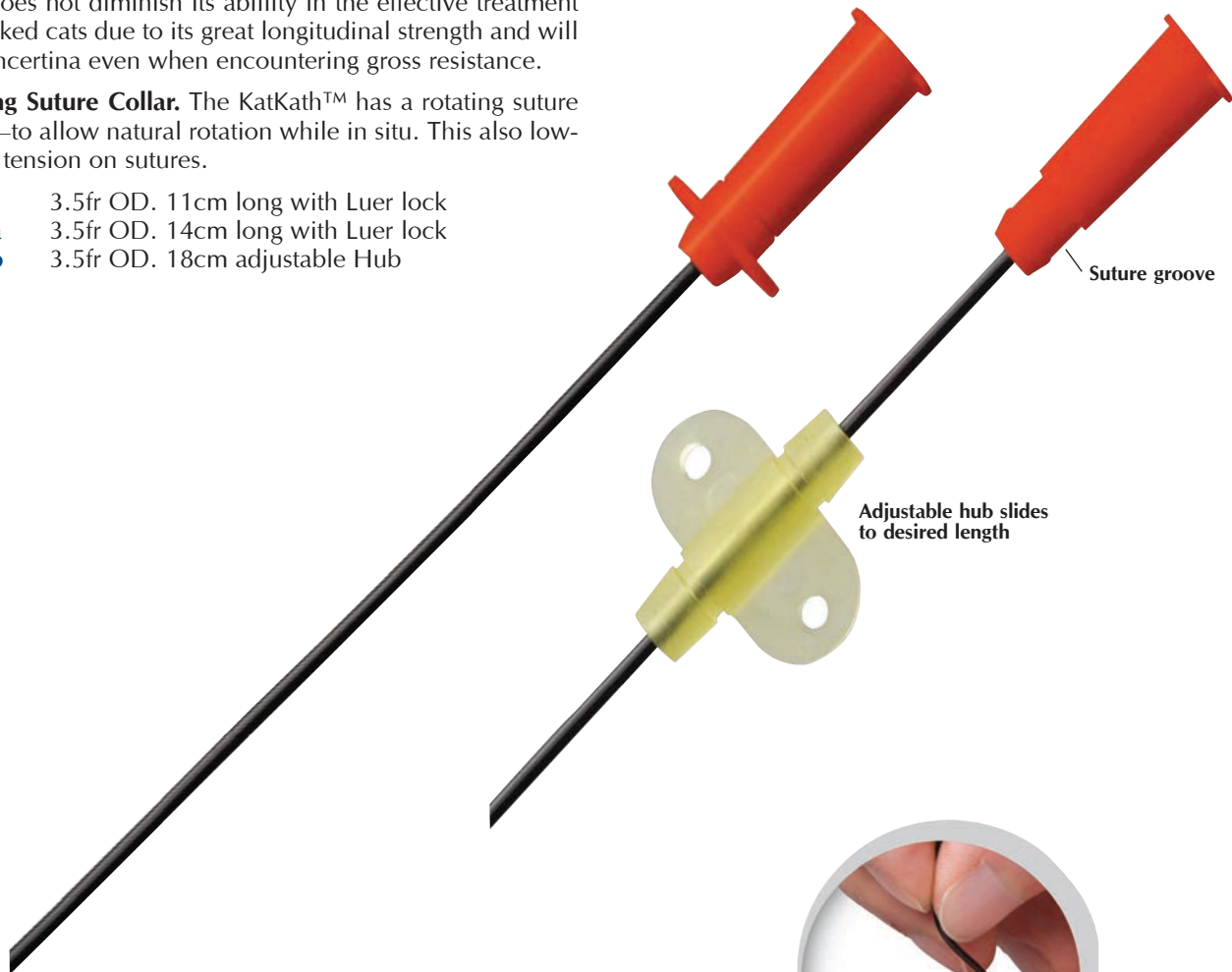

Suture groove

Adjustable hub slides to desired length



Increased flexibility

**J0164** **Lab Litter™.** FLUTD, or feline lower urinary tract disease, is a common problem in the feline patient. Obtaining high quality urine samples is a must to ensure proper diagnosis and treatment, plus as a follow-up in evaluating treatment results.

Lab Litter™ is a clear, non-absorbant, small plastic granule that feels like cat litter to the feline patient. It is used to help collect urine samples. Lab Litter™ is bulk packaged in an easy-to-pour gallon container. It is also available in prepackaged specimen cups for dispensing to clients.

- Priced considerably less than competing products
- Clear beads allow clearer view of sample versus darker black beads

**J0164** **Gallon Lab Litter™** bulk container. 5 lbs. 4 gallons/case.

**J0164a** **Individual Specimen Cups Lab Litter™.** 12/box.



J0164a

**J0165** **“Uro-Collect” Feline Urine Collection Kit.** The “Uro-Collect” system was developed as an easy-to-use and convenient kit for collecting a non-contaminated and diagnostic urine sample in either the clinic or at the owner’s home. 12/pk.

Kit includes:

- Litter pan liner
- 4.5–5 oz. polypropylene beads
- Reclosable bag
- Twist ties
- Complete client instructions

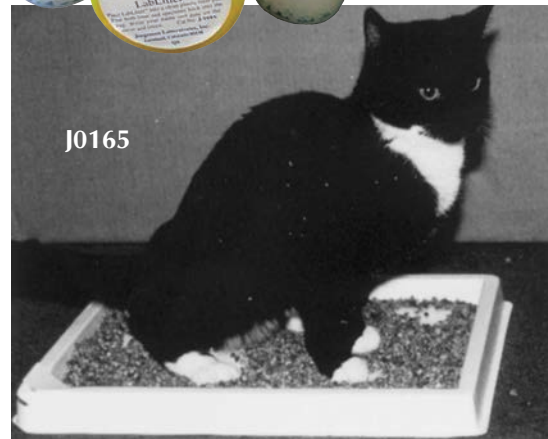

J0165

**J1001** **Litter Magnet™.** An all-natural solution to encourage litter box use. Litter Magnet™ will assist you in treating the most troubling behavioral problem a cat can have, inappropriate elimination, i.e. non-use of the litter box.

Often this problem is not medical and cannot be treated with medication. Treatment becomes a consultation with the pet owner, representing time spent for which it is often difficult to be compensated.

LitterMagnet™ and its supporting brochure will give you a product that can be prescribed with a tested solution that will help your customer get their cat” back to the box.”

An all-natural product, LitterMagnet™, uses its rich earthy fragrance to attract the cat to its litter box. Once the cat goes to the box and finds that it is clean and filled with an appropriate substrate, it will use it and positive behavior modification begins.

With LitterMagnet™, you can address a behavior problem and be able to prescribe a solution. You have also made a pet owner happy and possibly kept the cat out of a shelter or from being abandoned.

- LitterMagnet™ (JorVet Product #J1001)
- 20 oz bottle with a shake and pour lid
- Treats 100 pounds or more of clumping/scoopable clay litter
- A client education brochure is provided with each bottle
- 6 bottles per case

J1001



**Silicone Endotracheal Tube.** Silicone is the preferred material for endotracheal tubes. However, until now the cost was considered too high for use in most veterinary clinics. This is especially true on the larger sizes above 10mm.

When the endotracheal tube cuff is filled with air, it does not always fill symmetrically or is off center. This is most commonly with the silicon endotracheal tubes. These tubes are designed to be “compliant” meaning when placed into a body cavity such as the trachea the tube will fill to the open space evenly. This is also true of Foley catheters. However, if inflated outside of the body the tube will sometimes not inflate evenly. This is not a defect.

- Endotracheal tube with inflatable cuff
- Connector included
- Lateral murphy eye at distal tip
- Sizes 3mm to 14mm
- Fully transparent

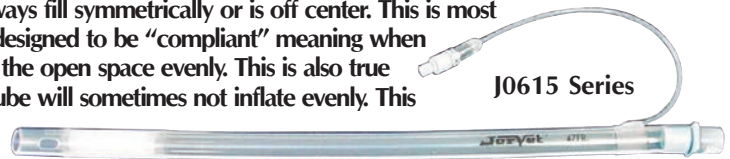

NOTE: Not autoclavable.  
Radiolucent

**Silicone Material Benefits:**

- **Patient comfort.** Silicone is a soft material that conforms to body contours. The soft distal tip lessens the chance for any airway tissue damage.
- **Reusability.** Intended to be used over and over again. Silicone resists deterioration better than PVC or red rubber
- **Transparent.** See any blood and mucous if they develop.

J0615a	Endotracheal Tube.	3mm i.d.	14fr	4.7mm o.d.	16cm L	balloon 3cm L
J0615b	Endotracheal Tube.	4mm i.d.	18fr	6.0mm o.d.	18cm L	balloon 3cm L
J0615c	Endotracheal Tube.	5mm i.d.	20fr	7.3mm o.d.	20cm L	balloon 4cm L
J0615d	Endotracheal Tube.	6mm i.d.	28fr	8.7mm o.d.	28cm L	balloon 4cm L
J0615e	Endotracheal Tube.	7mm i.d.	30fr	10.0mm o.d.	30cm L	balloon 5cm L
J0615f	Endotracheal Tube.	8mm i.d.	33fr	11.0mm o.d.	33cm L	balloon 5cm L
J0615g	Endotracheal Tube.	9mm i.d.	37fr	12.3mm o.d.	34cm L	balloon 5cm L
J0615h	Endotracheal Tube.	10mm i.d.	43fr	14.3mm o.d.	36cm L	balloon 5cm L
J0615j	Endotracheal Tube.	11mm i.d.	47fr	15.7mm o.d.	40 cm L	balloon 5cm L
J0615k	Endotracheal Tube.	12mm i.d.	51fr	17.0mm o.d.	44cm L	balloon 5cm L
J0615m	Endotracheal Tube.	14mm i.d.	57fr	18.0mm o.d.	48cm L	balloon 5cm L

**Sheridan Endotracheal Tube.** High quality clear PVC tubes but are inexpensive. Uniform inflatable cuff. Sterile.

- J0835a Endotracheal Tube. 3.0mm.
- J0835b Endotracheal Tube. 3.5mm.
- J0835c Endotracheal Tube. 4.0mm.
- J0835d Endotracheal Tube. 4.5mm.
- J0835e Endotracheal Tube. 5.0mm.
- J0835f Endotracheal Tube. 5.5mm.
- J0835g Endotracheal Tube. 6.0mm.
- J0835h Endotracheal Tube. 6.5mm.
- J0835j Endotracheal Tube. 7.0mm.
- J0835k Endotracheal Tube. 7.5mm.
- J0835m Endotracheal Tube. 8.0mm.
- J0835n Endotracheal Tube. 8.5mm.
- J0835p Endotracheal Tube. 9.0mm.
- J0835q Endotracheal Tube. 9.5mm.
- J0835r Endotracheal Tube. 10.0mm.



**Oversized Small Animal Endotracheal Tube.** Gray PVC material with white inflatable cuff. Includes adaptor. 21”L (52cm).

- J0835w Endotracheal Tube. 11mm.
- J0835x Endotracheal Tube. 12mm.
- J0835y Endotracheal Tube. 13mm.
- J0835z Endotracheal Tube. 14mm.

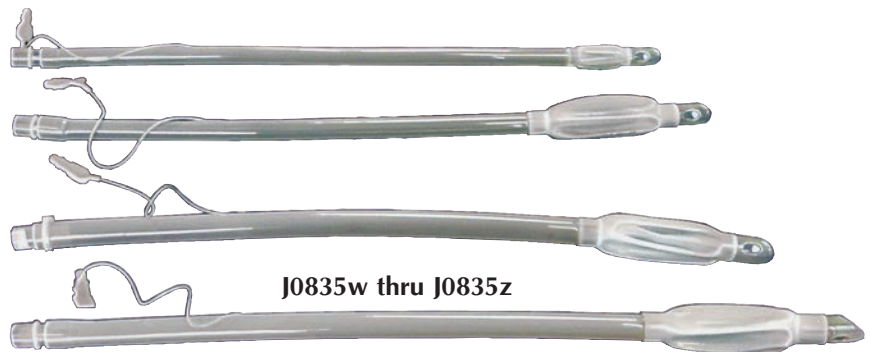



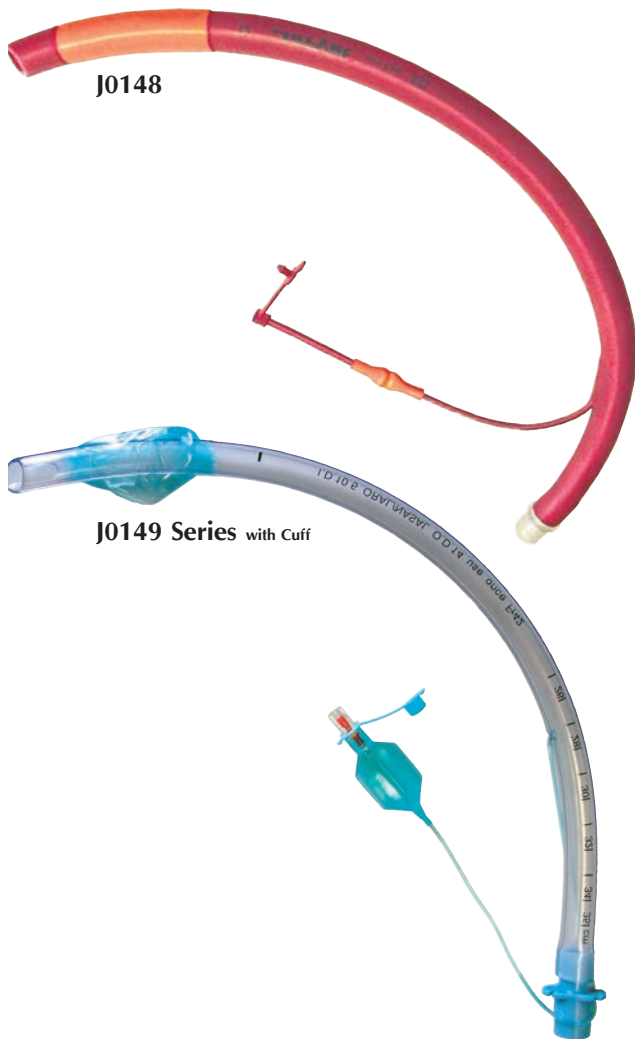

**JorVet Endotracheal Tube** with inflatable cuff. Available in .5mm increments from 2.5 to 11.0mm. Murphy eye. Red rubber. Hard-to-find extra-large size now available. (Adaptor not included except where specified.)

<b>J0148a</b>	<b>Tube.</b> 2.5mm.	<b>J0148L</b>	<b>Tube.</b> 8.0mm.
<b>J0148b</b>	<b>Tube.</b> 3.0mm.	<b>J0148m</b>	<b>Tube.</b> 8.5mm.
<b>J0148c</b>	<b>Tube.</b> 3.5mm.	<b>J0148n</b>	<b>Tube.</b> 9.0mm.
<b>J0148d</b>	<b>Tube.</b> 4.0mm.	<b>J0148o</b>	<b>Tube.</b> 9.5mm.
<b>J0148e</b>	<b>Tube.</b> 4.5mm.	<b>J0148p</b>	<b>Tube.</b> 10.0mm.
<b>J0148f</b>	<b>Tube.</b> 5.0mm.	<b>J0148q</b>	<b>Tube.</b> 10.5mm.
<b>J0148g</b>	<b>Tube.</b> 5.5mm.	<b>J0148r</b>	<b>Tube.</b> 11.0mm.
<b>J0148h</b>	<b>Tube.</b> 6.0mm.	<b>J0148s</b>	<b>Tube.</b> 12.0mm w/adaptor.
<b>J0148i</b>	<b>Tube.</b> 6.5mm.	<b>J0148t</b>	<b>Tube.</b> 13.0mm w/adaptor.
<b>J0148j</b>	<b>Tube.</b> 7.0mm.	<b>J0148u</b>	<b>Tube.</b> 14.0mm w/adaptor.
<b>J0148k</b>	<b>Tube.</b> 7.5mm.	<b>J0148v</b>	<b>Tube.</b> 16.0mm w/adaptor.

**Cuffed Endotracheal Tube.** Softens at body temperature, reducing postoperative irritation. Blue-tinted PVC tube complete with connector. Available in 0.5mm increments for 3.5mm to 11mm.

<b>J0149a</b>	<b>Tube.</b> 5.0mm.	<b>J0149i</b>	<b>Tube.</b> 9.0mm.
<b>J0149b</b>	<b>Tube.</b> 5.5mm.	<b>J0149j</b>	<b>Tube.</b> 9.5mm.
<b>J0149c</b>	<b>Tube.</b> 6.0mm.	<b>J0149k</b>	<b>Tube.</b> 10.0mm.
<b>J0149d</b>	<b>Tube.</b> 6.5mm.	<b>J0149L</b>	<b>Tube.</b> 10.5mm.
<b>J0149e</b>	<b>Tube.</b> 7.0mm.	<b>J0149m</b>	<b>Tube.</b> 11.0mm.
<b>J0149f</b>	<b>Tube.</b> 7.5mm.	<b>J0149vc</b>	<b>Tube.</b> 3.5mm.
<b>J0149g</b>	<b>Tube.</b> 8.0mm.	<b>J0149xc</b>	<b>Tube.</b> 4.0mm.
<b>J0149h</b>	<b>Tube.</b> 8.5mm.	<b>J0149yc</b>	<b>Tube.</b> 4.5mm.

**Non-Cuffed Endotracheal Tube.**

<b>J0149t</b>	<b>Tube.</b> 2.5mm.
<b>J0149u</b>	<b>Tube.</b> 3.0mm.
<b>J0149v</b>	<b>Tube.</b> 3.5mm.
<b>J0149x</b>	<b>Tube.</b> 4.0mm.
<b>J0149y</b>	<b>Tube.</b> 4.5mm.

*NOTE: The standard form for sizing endotracheal is to refer to inside diameter (i.d.).*

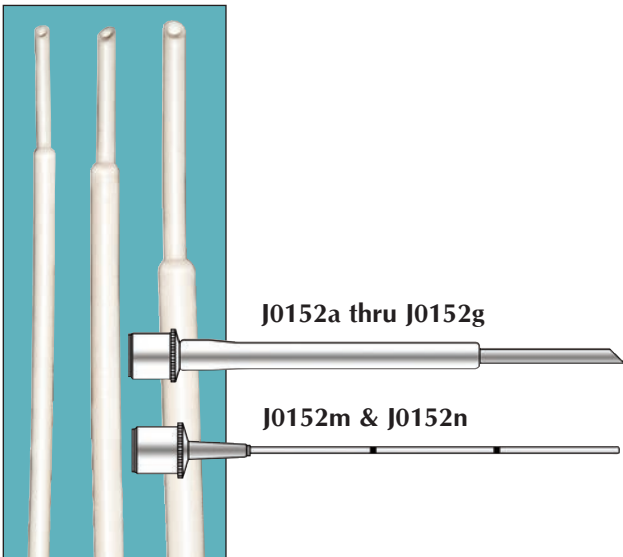

**Avian/Small Exotic Cole Endotracheal Tube.** Perfect for the smallest of patients. Lower profile on the distal end adds proper placement, and larger proximal end helps form a tighter seal. Stepped-down “Cole”-style wall. Silicone. Complete with attached standard 15mm connector.

<b>J0152a</b>	<b>Tube.</b> 2.0mm i.d. x 9.0fr x 5.0mm o.d.
<b>J0152b</b>	<b>Tube.</b> 2.5mm i.d. x 12.0fr x 6.3mm o.d.
<b>J0152c</b>	<b>Tube.</b> 3.0mm i.d. x 13.6fr x 8.0mm o.d.
<b>J0152e</b>	<b>Tube.</b> 4.0mm i.d. x 18.3fr x 9.6mm o.d.
<b>J0152f</b>	<b>Tube.</b> 5.0mm i.d. x 23.6fr x 12.6mm o.d.
<b>J0152g</b>	<b>Tube.</b> 6.0mm i.d. x 27.6fr x 15.1mm o.d.

**Avian/Smallest of Small Exotic Endotracheal Tube.** Straight tube design with a wire guide stylet for ease of intubation. Non-cuffed. All silicone. Complete with 15mm connector.

<b>J0152m</b>	<b>Tube.</b> 1.0mm i.d.
<b>J0152n</b>	<b>Tube.</b> 1.5mm i.d.

**EZ Tie**

**Endotracheal Tube Securing Device.** So simple, you'll wonder why you did not think of it!! Maintaining an endotracheal tube in the correct position is a critical component of anesthesia or surgery. Any shift or displacement of an endotube during anesthesia can be life-threatening. A common practice is to use a length of cotton gauze roll to first tie around the tube then around the animal's muzzle. Roll gauze can come untied or be difficult to quickly untie.

The **EZ Tie** was designed to be quick and easy to hold any endotracheal or anesthesia mask safely in place. The thin but strong plastic tubing has two sliding clasps. These clasps readily move along the tubing but hold steady under tension. The first clasp is used to tighten around the ET tube or mask. The second slides along to tighten around the patient's muzzle.

It also works extremely well with challenging brachycephalic breeds such as pugs and felines. *Will work with most anesthesia masks!*



The **EZ Tie** is:

- Simple to apply
- Reusable and durable
- Light weight
- Can hang in induction area ready for use
- Inexpensive
- One size fits all
- Watch short video on [www.JorVet.com](http://www.JorVet.com)
- Not autoclavable

**J1202 EZ Tie.** Pack of 3



slips over mask connector



tightens

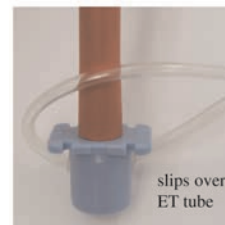

slips over ET tube



tighten onto ET tube

**Silicone Endotracheal Tube with Wire Reinforcement.** Silicone is a great material for endotracheal tubes because it provides superior biocompatibility and flexibility. These tubes have a metal wire reinforcement that spirals the length of the tube. This reinforcement gives rigidity and prevents any possible occlusion.

Features:

- Graduations to aid in depth placement
- Radiopaque line for location confirmation
- Fully transparent to allow observation for development of blood or mucus
- Lateral Murphy eye
- 15mm connector included

**Tube without Cuff.**

<b>J0629a</b>	<b>Tube.</b> 2.5mm i.d.	4.0mm/12fr o.d.	140mm L.
<b>J0629b</b>	<b>Tube.</b> 3.0mm i.d.	4.7mm/14fr o.d.	160mm L.
<b>J0629c</b>	<b>Tube.</b> 4.0mm i.d.	6.0mm/18fr o.d.	200mm L.
<b>J0629d</b>	<b>Tube.</b> 5.0mm i.d.	7.3mm/22fr o.d.	240mm L.

**Tube with Inflatable Cuff.**

<b>J0629e</b>	<b>Tube.</b> 6.0mm i.d.	8.7mm/20fr o.d.	280mm L.
<b>J0629f</b>	<b>Tube.</b> 7.0mm i.d.	10.0mm/30fr old.	300mm L.
<b>J0629g</b>	<b>Tube.</b> 8.0mm i.d.	11.3mm/34fr o.d.	320mm L.
<b>J0629h</b>	<b>Tube.</b> 9.0mm i.d.	12.7mm/38fr o.d.	340mm L.
<b>J0629j</b>	<b>Tube.</b> 10.0mm i.d.	14.0mm/42fr o.d.	360mm L.

**J0615x Swine Endotracheal Tube.** Especially designed with the cooperation of leading research centers for use in swine. Silicone. Graduated marking with standard adaptor, inflatable cuff, radio-paque, and lateral Murphy eye. Extra-long length. 8mm i.d. x 18"(47cm).

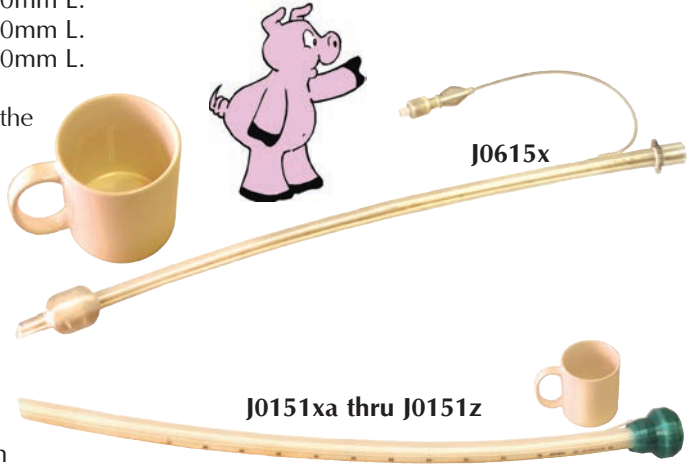
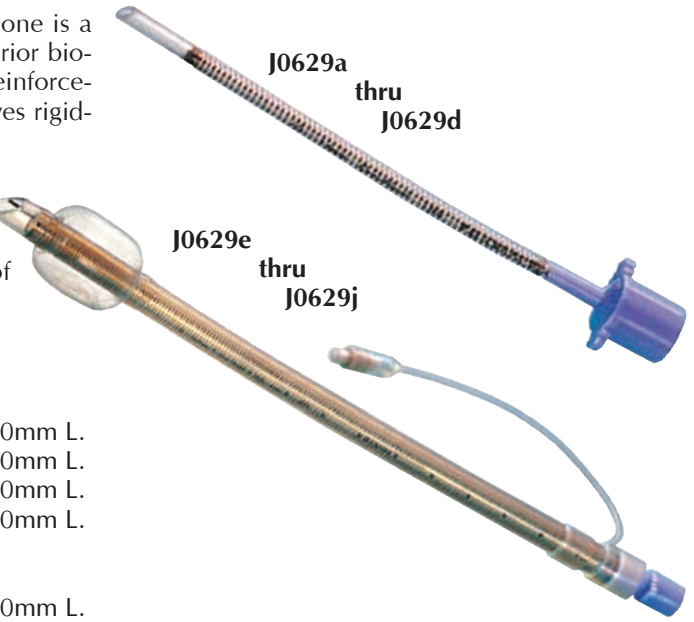

**Equine Silicone Endotracheal Tube.** Universal fitting allows connection to most large animal anesthesia machines and ventilators.

<b>J0151xa</b>	<b>Tube.</b> 16mm i.d.	8cm L balloon	70cm L total
<b>J0151xb</b>	<b>Tube.</b> 18mm i.d.	8cm L balloon	75cm L total
<b>J0151x</b>	<b>Tube.</b> 20mm i.d.	10cm L balloon	90cm L total
<b>J0151y</b>	<b>Tube.</b> 24mm i.d.	12cm L balloon	100cm L total
<b>J0151z</b>	<b>Tube.</b> 30mm i.d.	14cm L balloon	100cm L total

**Cuff Repair Kits.**

<b>J0151yrc</b>	<b>24mm</b>
<b>J0151zrc</b>	<b>30mm</b>
<b>J0151xcrc</b>	<b>22mm</b>
<b>J0151yarc</b>	<b>26mm</b>



**J0151at Silicone adhesive for repair of endotube cuffs.**

Must be purchased separately.

**Equine Nasotracheal Tube.** A cuffed nasotracheal tube used to deliver anesthesia gases and oxygen via nasal intubation. The tubes have a standard 15mm connector.



	ID	OD	Length
<b>J0694</b>	<b>7mm</b>	10.0mm	55cm
<b>J0694a</b>	<b>9mm</b>	12.3mm	55cm
<b>J0694b</b>	<b>11mm</b>	15.7mm	55cm



**Portex Endotracheal Adaptor and Connectors.** The full range of small animal endotracheal tubes is covered by the twelve adaptors included here. The adaptors may be sterilized by conventional methods. The compact Swivel Connector may be rotated a full 360°, affording maximum positioning and flexibility. For use on all endotracheal tubes.

The various adaptors are available in individually packaged sizes from 2.5–15mm.

<b>J0157a</b>	2.5mm.	<b>J0157hh</b>	7.5mm.
<b>J0157aa</b>	3.0mm.	<b>J0157i</b>	8.0mm.
<b>J0157aaa</b>	3.5mm.	<b>J0157ii</b>	8.5mm.
<b>J0157b</b>	4.0mm.	<b>J0157j</b>	9.0mm.
<b>J0157c</b>	4.5mm.	<b>J0157jj</b>	9.5mm.
<b>J0157d</b>	5.0mm.	<b>J0157k</b>	10.0mm.
<b>J0157e</b>	5.5mm.	<b>J0157kk</b>	10.5mm.
<b>J0157f</b>	6.0mm.	<b>J0157L</b>	11.0mm.
<b>J0157g</b>	6.5mm.	<b>J0157t</b>	12.0mm.
<b>J0157h</b>	7.0mm.	<b>J0157v</b>	15mm Endo Adapter.

**J0157z** **One-Way Valve for Endotube Cuff Inflation.**

**J0157s** **Swivel Connector.** Allows movement between endotracheal tube and anesthesia circuit.

**J0167q** **JorVet Endolight.** New and improved, this small penlight has an attached flexible metal rod with a small wheat-head-size bulb. A small endotracheal tube 6mm easily slides over the rod. Gives rigidity and great illumination when intubating small dogs and cats. Makes a small keyhole task simple. Operates on "AA" batteries (included). 10" shaft.

**J0167qd#1 Bulb** only.

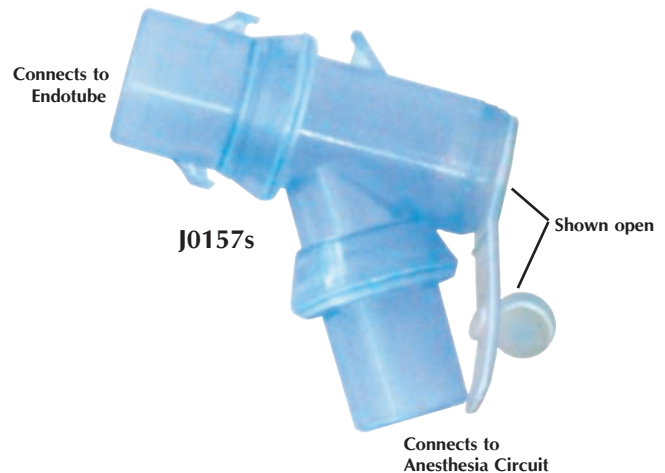

**Endotracheal Tube Stylet.** Intubation is made easier when using a rigid stylet for the endotracheal tube. This stylet is a plastic coated malleable metal wire. One end has a rubber stopper that fits tightly over the endotracheal tube connector. It can slide to adjust for proper length. This stylet works especially well with silicon tubes that are less rigid than other tubes.

<b>J0149sta</b>	<b>Stylet.</b> Fits tube sizes 2.0–3.5mm.
<b>J0149stb</b>	<b>Stylet.</b> Fits tube sizes 4.0–6.5mm.
<b>J0149stc</b>	<b>Stylet.</b> Fits tube sizes 7.0–10.0mm.

**Endotracheal Tube Cleaning Brush.** Stainless steel shaft. Malleable.

<b>J0151q</b>	<b>Brush.</b> 4.0mm, cleans ≥5.0mm tubes.
<b>J0151s</b>	<b>Brush.</b> 8.0mm, cleans ≥8.0mm tubes.

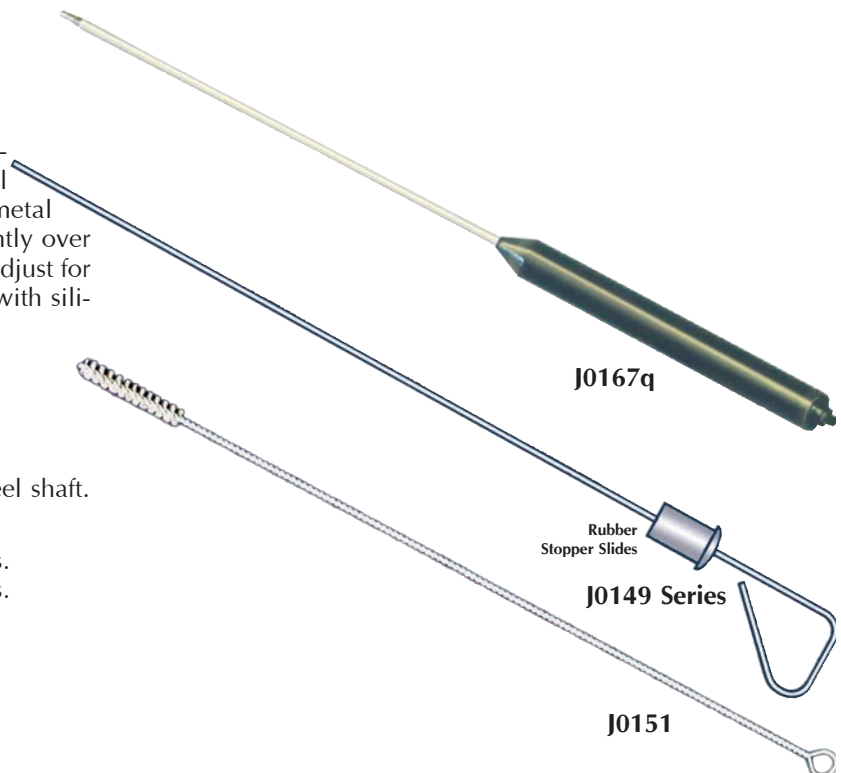

**J0449 Laryngoscope.** Great for intubating animals and for examination of the pharyngeal area. First choose your handle, then match it with your choice of blade. JorVet handles and blades will interchange with those of other manufacturers.

**J0449m Standard Medium Handle** only. Uses 2 "C" batteries. (not included)

**J0449p Special Penlight Handle** only. Works great for cats. Uses 2-AA batteries (not included).

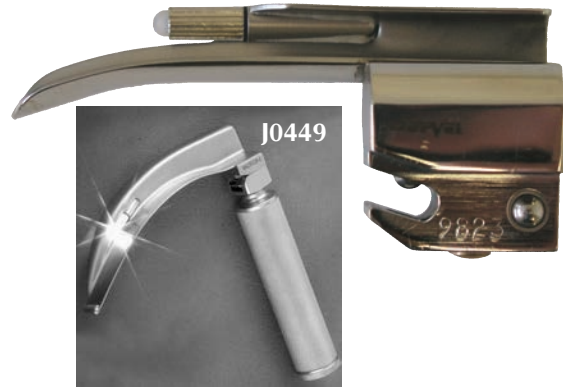

**Laryngoscope Blades.** JorVet features two different models of laryngoscope blades.

*NOTE: Blade length is entire shaft.*

**Miller Laryngoscope Blade.** Straight shaft with gentle curved tip.

<b>J0449a</b>	<b>Blade.</b>	53mm.	#0
<b>J0449b</b>	<b>Blade.</b>	80mm.	#1
<b>J0449c</b>	<b>Blade.</b>	130mm.	#2
<b>J0449d</b>	<b>Blade.</b>	173mm.	#3
<b>J0449e</b>	<b>Blade.</b>	180mm.	#4

**J0449f Miller Laryngoscope Blade.** Designed to work for swine intubations. 12"L. (not pictured)

**McIntosh Laryngoscope Blade.** Curved along entire length of blade.

<b>J0449am</b>	<b>Blade.</b>	60mm.	#0
<b>J0449bm</b>	<b>Blade.</b>	66mm.	#1
<b>J0449cm</b>	<b>Blade.</b>	85mm.	#2
<b>J0449dm</b>	<b>Blade.</b>	110mm.	#3
<b>J0449em</b>	<b>Blade.</b>	140mm.	#4

**McIntosh**

**Miller**



**J0449s Laryngoscope Kit.** A handy kit in a black leatherette zipper pouch.

- Includes:
- 3 MacIntosh blades #1, #2, and #4
  - 3 Miller blades #1, #2, and #4
  - 1 medium handle



**Replacement Light Bulb.**

**J0449r Short Bulb.** Used for **J0449a**, **J0449b**, **J0449c** and **J0449am** blades. Size (L) 10mm and 3mm (W).

**J0449rL Long Bulb.** Used for **J0449c** through **J0449f** and **J0449bm** through **J0449em** blades. Size (L) 12 mm and 6mm (W).

**Magill Intubation Forceps.** These forceps have a long shaft with a small doughnut shaped end. Also useful for grasping foreign bodies or inserting drains. More powerful than an alligator forceps.

- J0631a Intubation Forceps.** Small.
- J0631b Intubation Forceps.** Medium.
- J0631c Intubation Forceps.** Large.



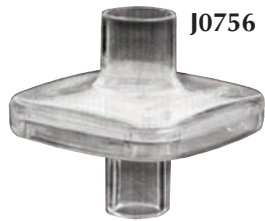

**J0756 Bacterial/Viral Filter.** Filter fits onto a standard anesthesia circuit to remove possible pathogens.

- Bacteria/viral filtration 99.99%+
- Dead space 42ml
- 22mm i.d. x 15mm i.d./22mm o.d.
- Individually packed. 3/pk.



**J0247 JorVet Resuscitation Bag.** For emergency artificial respiration. This device is ideal for administering either pure oxygen or room air to oxygen deprived patients. Special valve allows lung inflation upon compression of bag and passive exhalation of CO<sub>2</sub> while fresh air refills up the compressor bag. Two options include your choice of hooking up to a central oxygen source or detaching and using room air. Attachment will fit standard endotracheal tube or can be used with an airtight mask. 2-liter.



**J0247a Cat and Small Dog Bag.** Pressure limiting valve to avoid damaging smaller patient lungs. 1-liter.



**Esophageal Stethoscope.** Attaches to standard stethoscope by removing stethoscope bell.

- J0205a Esophageal Stethoscope.** 12fr. 20"L.
- J0205b Esophageal Stethoscope.** 18fr. 20"L.
- J0205c Esophageal Stethoscope.** 24fr. 20"L.



**J0265 Anesthesia Chamber.** The Lexan anesthesia chamber provides a simple method of induction. Chamber induction reduces physical restraint which minimizes stress and reduces the chance of injury to the operator and animal.

The divider system allows three different size chambers within the one unit: 18" x 9" x 9", 12" x 9" x 9", and 6" x 9" x 9". 10 lbs.



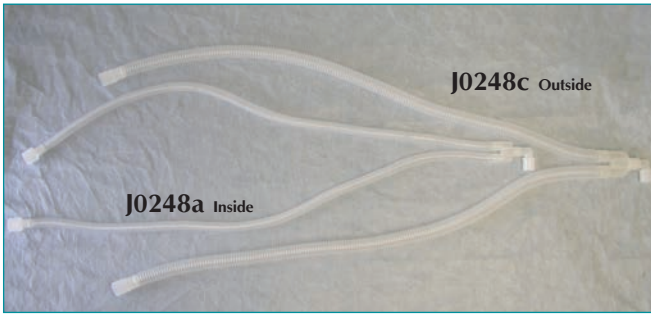

**Disposable Pediatric Anesthesia Circuit.** For use with smaller patients, this lessens the amount of dead space. Consists of two 30" breathing tubes ( $\frac{5}{8}$ " ), inhaler "Y" piece and mask elbow. Clear color.

- J0248a Complete Circuit** without 1-liter breathing bag.
- J0248b Complete Circuit** with 1-liter breathing bag.

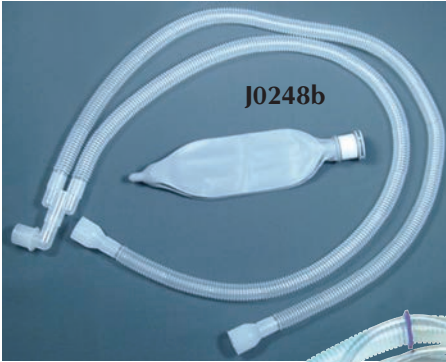

**Disposable Adult Anesthesia Circuit.** Adult disposable anesthesia breathing circuit consists of two 40" breathing tubes ( $\frac{7}{8}$ " ), inhaler "Y" and mask elbow. Natural color.

- J0248c Complete Circuit** without 3-liter breathing bag.
- J0248d Complete Circuit** with 3-liter breathing bag.

**J0248e Disposable Ayers Non-Rebreathing Circuit.** For very small patients (under 10 lbs.) who cannot use rebreathing systems due to dead space complications. 0.5-liter bag.

- J0248ea Disposable Ayers Non-Rebreathing Circuit** with 1-liter bag with tail bleed valve.

*NOTE: Scavenger tubing not included.*



- J0248g Modified Jackson Reese.** Non-rebreathing circuit. This model has a side vent above the bag. It is closed by sliding an on/off button for "bagging an animal." The bag does not have a tail bleed on its end. Complete with 1-liter bag.

**Universal "F" Circuit.** This is the popular uni-limb circuit that is a tube within a tube circuit.

Features:

- One 40" hose for lighter weight and maneuverability around the patient's head.
- Exhaled gas warms up incoming fresh gas.
- Attaches to any standard anesthesia machine.



- J0248f Complete Circuit** with 2-liter breathing bag.
- J0248fL Complete Circuit** with 2-liter breathing bag — 60" hose.
- J0248fa Complete Circuit** without 2-liter breathing bag.
- J0248fLa Complete Circuit** without 2-liter breathing bag — 60" hose.

**Pediatric Universal "F" Circuit.** For animals weighing 4Kg–20Kg.

Features:

- Smaller diameter tubing with less dead space than standard uni-limb system

- Pink colored inner tubing 40"
- one 40" hose



- J0248k Complete Pediatric Circuit** with 1-liter bag.
- J0248kL Complete Pediatric Circuit** with 1-liter bag — 60" hose.
- J0248ka Complete Pediatric Circuit** without 1-liter breathing bag.
- J0248kLa Complete Pediatric Circuit** without 1-liter breathing bag — 60" hose.

**Scavenge Tubing.**

- J0248t 22mm Scavenge Tubing.** 10' roll. (not pictured)
- J0248q 19mm Scavenge Tubing.** 10' roll. (not pictured)

*NOTE: Custom scavenge tubing lengths available.*

*NOTE: Non-Rebreathing Systems (J0248e, ea, g and J0297 an, bn, cn, dn have no replacement parts available.*

**Anesthesia Mask** with low dead space, clear plexiglas masks with black rubber diaphragm.

- J0298c Mask.** Canine. 5" opening.
- J0298f Mask.** Feline. 3 1/2" opening.
- J0298cd1** Diaphragm only for J298c.
- J0298fd1** Diaphragm only for J298f.



**Hall's Anesthesia Mask.** Soft, malleable black rubber. This mask will conform to the animal's muzzle shape, allowing a custom fit. Standard 15mm connection to anesthesia circuit.

- J0298ha Mask.** Small. 3 1/2"L x 2 1/2" dia.
- J0298hb Mask.** Medium. 3 1/2"L x 4 1/2" dia.
- J0298hc Mask.** Large. 6 1/2"L x 4 1/2" dia.



**Disposable Respiratory Face Mask.** A crystal clear plastic material with inflation/deflation valve for better patient fitting. Inexpensive. 15mm OD fitting. This one way valve inflates with any standard syringe.

- J0298da Mask.** 2" i.d. widest area x 3 1/2" vertical i.d.
- J0298db Mask.** 2" i.d. widest area x 2 1/2" vertical i.d.
- J0298dc Mask.** 1 3/4" i.d. widest area x 2 1/4" vertical i.d.
- J0298dd Mask.** 1" i.d. widest area x 1 3/4" vertical i.d.
- J0298de Mask.** 1 1/4" i.d. widest area x 1 1/4" vertical i.d.
- J0298ds Masks.** Set of 5.



**Exotic/Small Animal Anesthesia Mask and Non-Rebreathing Circuit.** These especially small masks were specifically designed for use on small exotics such as pocket pets and birds. The small circuit hooks up the same way as a non-rebreathing circuit does to an anesthesia machine. The masks fit tight around the nose and mouth. Soft conforming cone can be trimmed to custom fit animal's nose. The oxygen/gas tube position can be adjusted inside mask. Also circuit can be taped to the table to help keep it positioned on the animal's nose or muzzle.

- J0297an Mask.** 9.0mm Opening, 10" tubing.
- J0297bn Mask.** 12.5mm Opening, 10" tubing.
- J0297cn Mask.** 14.0mm Opening, 10" tubing.
- J0297dn Masks.** Set of All Three.

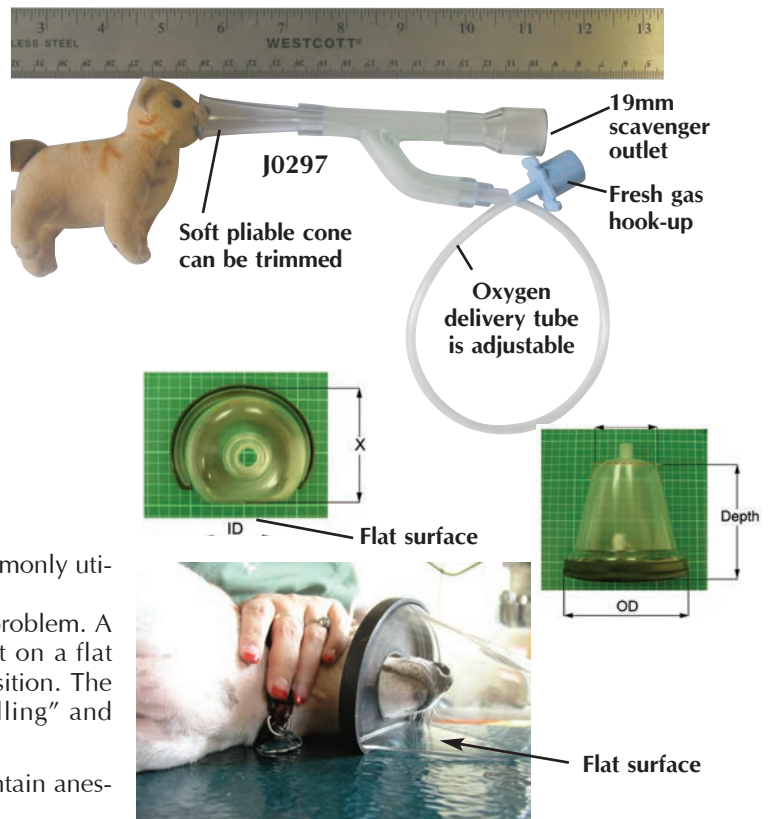

**Eldridge Anesthesia Mask.** Anesthesia masks are a commonly utilized piece of equipment in veterinary clinics.

The Eldridge Anesthesia Mask addresses a common problem. A standard round mask wants to roll away from patient on a flat table. Towels are often used to brace the mask into position. The Eldridge mask is flat on one side to prevent this "rolling" and safely keep the mask in position. Patent pending.

- Used to induce gas anesthesia and sometimes maintain anesthesia in patients
- Provides oxygen therapy in patients with severe respiratory distress

		OD	Mask Depth	Opening	Replacement diaphragms
<b>J0355</b>	<b>feline/small canine</b>	3.5"	3"	1"	<b>J0355d1</b>
<b>J0355a</b>	<b>canine up to 50lbs</b>	5"	4.75"	1.75"	<b>J0355ad1</b>
<b>J0355b</b>	<b>x-large canine</b>	6"	5.75"	3"	<b>J0355bd1</b>
<b>J0355s</b>	<b>Set of all 3</b>				

See video at [www.JorVet.com](http://www.JorVet.com)



**Disposable Breathing Bags.** High quality latex.

- J0249a** **0.5-Liter Bag** only. 7/8" neck i.d. Warranty for manufacturer defects only.
- J0249b** **1.0-Liter Bag** only. 7/8" neck i.d. Warranty for manufacturer defects only.
- J0249b2** **2.0-Liter Bag** only. 7/8" neck i.d. Warranty for manufacturer defects only.
- J0249c** **3.0-Liter Bag** only. 7/8" neck i.d. Standard size.
- J0248ed1** **0.5-Liter Bag** with tail bleed valve.
- J0248ead1** **1.0-Liter Bag** with tail bleed valve.

J0249 Series



**Breathing Tube/Hose.** Corrugated black rubber conductive breathing tubes with natural rubber 22mm cuff inserts.

- J0249h** **Hose.** 36"L.
- J0249j** **Hose.** 40"L.



**Reusable Black Rubber Breathing Bags.** Our oval/flat breathing bags are manufactured of black natural rubber. High quality and long lasting.

- J0249q** **0.5-Liter Bag.**
- J0249w** **15L black rebreathing bag**
- J0249z** **30L black rebreathing bag**

**22mm Neck Insert.** (standard fitting)

- J0249r** **1.0-Liter Bag.**
- J0249r2** **2.0-Liter Bag.**
- J0249s** **3.0-Liter Bag.**
- J0249t** **4.0-Liter Bag.**
- J0249v** **5.0-Liter Bag.**



**50mm Neck Insert.** (standard fitting)

- J0249e** **6.0-Liter Bag.**

**J0249y** **Wye or "Y" Connector** with swivel on both legs for better positioning; two legs fit standard 22mm anesthetic hoses, neutral-colored nylon; third leg fits 15mm endotracheal tube connector.

**J0249x** **Wye or "Y" Connector Rigid.** Two legs fit standard 22mm anesthetic hoses, and third leg fits 15mm endotracheal tube connectors.

**J0160** **Endotube Rack.** Attractive and convenient way to store up to 20 endotracheal tubes. The rack keeps tubes arranged by size for quick access in any emergency. It attaches easily to most wall surfaces by four adhesive strips, and metal screws (included). 20" x 11". 4 lbs.

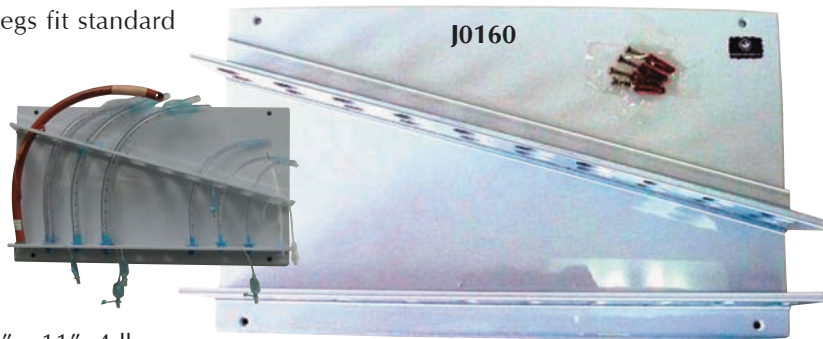

**Endotracheal Tube Rack Cover.** Protective storage of endotracheal tubes is a requirement for AAHA Hospitals. JorVet is now offering a clean protective cover for clinics using our popular existing J-160 Endotube Rack. It gives a nice professional look to endotube storage.

- Magnetic lock: holds door closed, but opens easily
- Metal hinge includes mounting screws and wall expanders
- Able to mount on most surfaces

- J0160c** **ET Tube Rack Cover Only.**
- J0160a** **ET Tube Rack and Cover.**
- J0160** **ET Rack Only.**

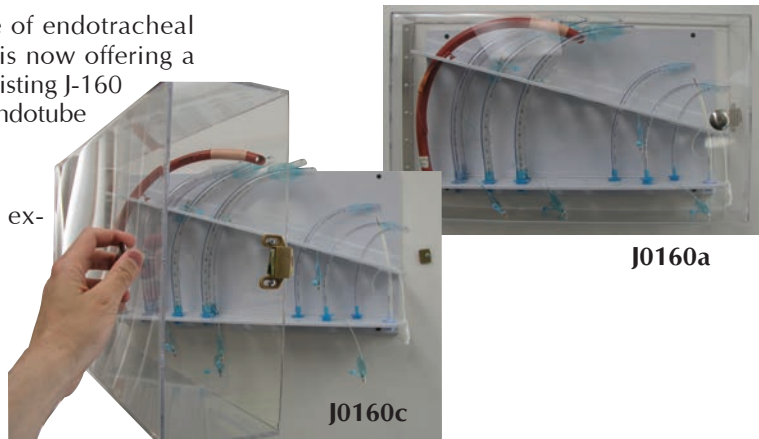



There is an increasing awareness among veterinarians and their staff about the health hazards of breathing waste anesthetic gases. The **JorVet GasVak Scavenger System** is an active unit that removes waste anesthetic gases at the pop-off valve on all anesthetic machines or from the end of a non-rebreathing system. The waste gas is then vented outside the clinic via a vacuum fan power unit.

- Mounted next to outside wall
- Up to 25' of tubing or PVC pipe can be on exhaust, allowing exit through the ceiling or going up and over another room.
- Works best with one anesthesia location and one anesthesia machine.
- Scavenger tubing provided

**J0301 GasVak Single Station Unit.**

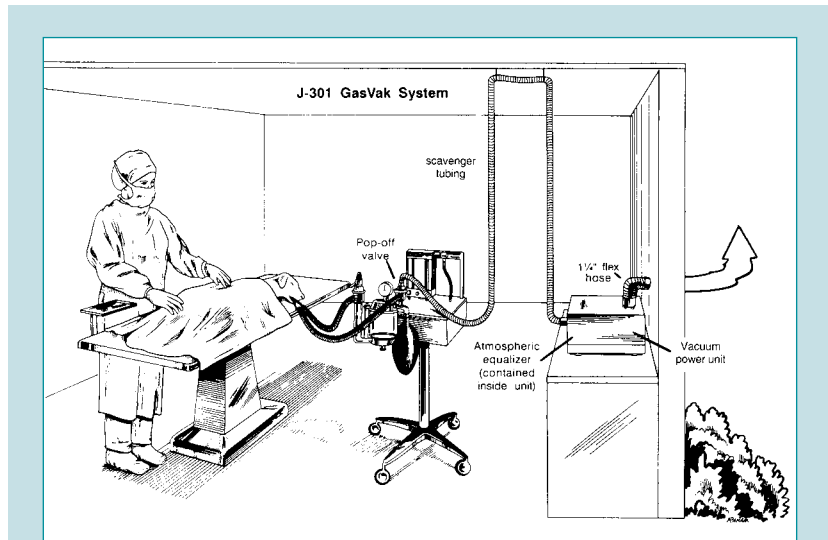

**Breath Fresh Anesthesia Gas Filter.** Activated charcoal canisters remove up to 50g of waste anesthetic gas. They attach to standard 19mm scavenger hose.

Features:

- Inexpensive refills available to fit JorVet or other brands
- Lasts 12-15 hours of anesthesia
- Simple to use: connect and ready to go
- Mounts right on anesthesia machine pole

Dimensions:

- Height: 15 cm (6")
- Weight of active components: 200g
- Diameter: 7.5cm (3")
- Connector: 19mm o.d.

**J0304 Canister.** Complete.

**J0304r Refill Kit.** 200g.

**J0304k Mounting Kit,** includes:

- Mounting bracket for attachment to anesthesia pole
- Breath Fresh canister
- 19mm tubing 40"L

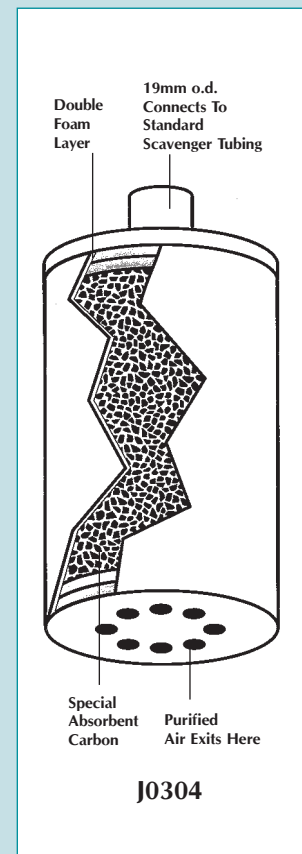

**Gas Scavenging Tune-Up Kit** has a wide range of tubing and connectors that are standard size. The kit will work with all brands of scavenger systems used today in the veterinary field, and will keep your scavenger system working up to its full potential.

*NOTE: OSHA's limits for employee exposure to anesthetic gas is just 2 ppm during an 8-hour day.*

**Tune-up Kit** consists of:

- 22mm corrugated clear tubing. 15'.
- 19mm corrugated blue tubing. 15'.
- Four adaptors. 22mm o.d. x 22mm o.d./15mm i.d.
- Two adaptors (cuffs). 22mm o.d. x 22mm i.d.
- Two adaptors. 19mm i.d./22mm o.d. x 22mm o.d./15mm i.d.

**J0302t Gas Scavenging Tune-Up Kit.**

**Multi-Station GasVak Unit.** There is an increasing awareness among veterinarians and their staff about the health hazards of breathing waste anesthetic gases. The JorVet GasVak Scavenger system is an active unit that removes waste anesthetic gases at the pop-off valve on all anesthetic machines or from the end of a non-rebreathing system. The waste gas is then vented outside the clinic via a vacuum fan power unit.

- For facilities with more than one anesthesia location
- Ceiling outlet or balancing valve at each location
- Each anesthesia machine has a scavenger interface or atmospheric equalizer mounted on gas machine

**J0302 Multi-Station GasVak Unit** comes complete with:

- Two balancing valves
- Two atmospheric equalizers

**J0302w Multi-Station GasVak Unit with Wall Mount Balancing Valves.**

For each anesthesia station the following equipment is needed:

**J0302d1 Atmospheric Equalizer.** One per anesthesia machine.

**J0302d2 Balancing Valve.** One per anesthesia station.

**J0302d2w Wall Mount Balancing Valve.**

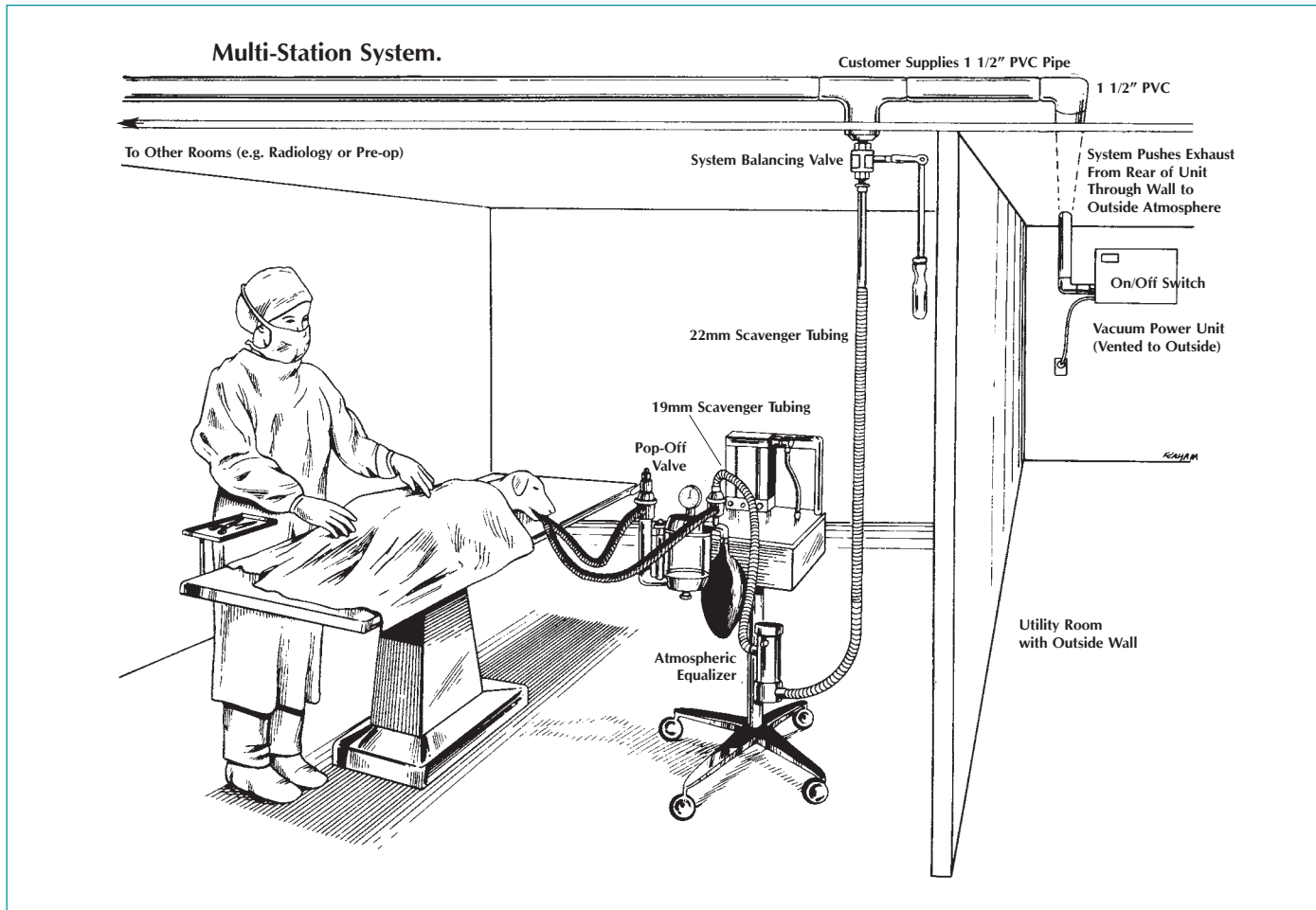

### Oxygen Connectors and Gas Hose Assembly

A tremendous variety of options are available to design your own oxygen delivery system or add to an existing setup. A wide range of patterns of oxygen connectors is available with the DISS, Chemtron and Ohio style quick connect being the most popular. ALL connectors and oxygen hose assemblies are custom assembled and non-returnable

If you are considering building, expanding or remodeling your practice Jorgensen Laboratories can provide experienced consulting for all of your Anesthesia and Medical gas needs. This includes medical gas piping and general layout design.

**NOTES about connectors:**

**DISS** = Diameter Index Safety System.

These fittings are designed to prevent errors and standardized connections. Only oxygen DISS male threads will match female oxygen DISS threads. Nitrous oxide and other gases each have their own thread patterns.

**NPT** = National Pipe Thread Sizing.

These relate to anesthesia machine fittings.

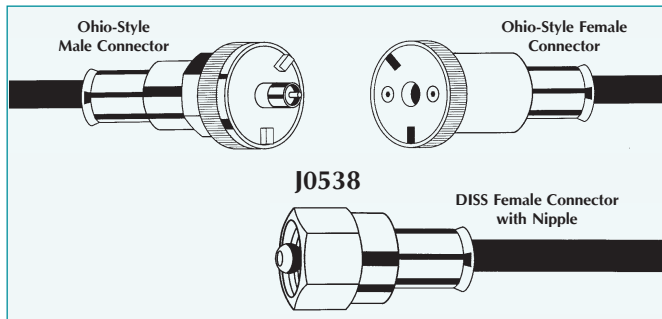

**Gas Hose Assembly.** Design your own custom oxygen or other gas line. FDA medical grade conductive hose that is kink resistant, lightweight, and reinforced with tough nylon braiding. Fittings are chrome-plated brass. Standard 1/4" i.d. **Custom-made and non-returnable.**

- Color-coded to specific gas; green = oxygen

**Oxygen Hose Assembly.** (hose not included)

	One-End Connector	Opposite-End Connector
J0538a	Female DISS	x Ohio-Style Male Quick Connect
J0538b	Female DISS	x Female DISS
J0538c	Female DISS	x Ohio-Style Female Quick Connect
J0538e	Female Ohio	x Male Ohio
J0538f	Female DISS	x Female Chemtron
J0538m	Female DISS	x Male Chemtron

Combine connectors and amount of tubing needed for total pricing. **J0540 O<sub>2</sub> hose** specify length (feet).

The above six hose assemblies are the most popular. Other connectors are listed below. Ordering procedure for oxygen hoses if not choosing a hose assembly from those listed above.

1. pick two ends of hose desired
2. determine the number of oxygen hose in feet desired (**J0540**)

**Oxygen hose fittings**

<u><b>DISS fitting</b></u> Barbed end	<u><b>Ohio Quick Connect</b></u> Barbed fitting
J0533g female	J0535fa Female Ohio
J0533h male	J0535a male
J0533j female twist off	
<u><b>Chemtron</b></u> Barb fitting	<u><b>Puritan-Bennett</b></u> Barb fitting
J0536fa female	J0536xa female
J0536a male	J0536x male
<u><b>Schrader</b></u>	<u><b>Oxequip</b></u>
J0536yb female	J0536t male
J0536y male	

**Nitrogen hose assembly.**

J0538ns	Female DISS	x	Female Schrader
J0540n	Black nitrogen hose		

NOTE: hose assemblies also available for:  
Nitrous oxide  
WAGD was gas evacuation  
Vacuum/suction

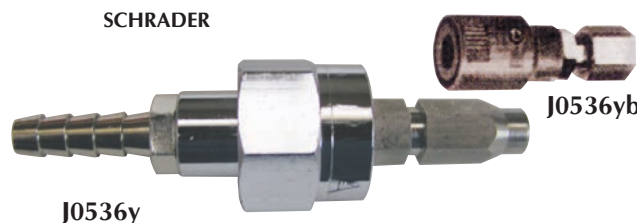
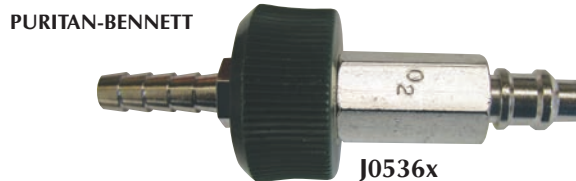
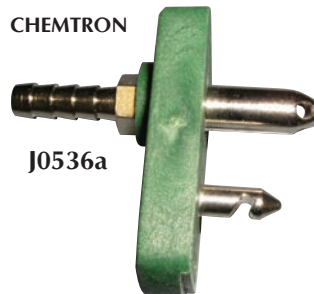
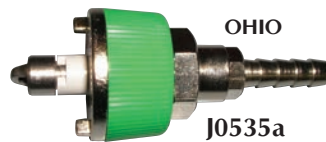



**Other Miscellaneous Connectors**

- J0533x** Female DISS to male DISS check valve gives one-way flow
- J0533z** Male DISS to female DISS with reverse check valve gives one-way flow
- J0538x** 1/4" NPT female x 1/4" male check valve gives one-way flow
- J0533m** Male DISS/male DISS fitting
- J0533f** Female DISS/female DISS fitting
- J0539dm** DISS male x 1/4" male NPT
- J0539dmc** DISS male with demand valve x 1/4" male NPT

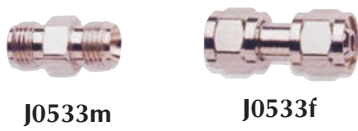
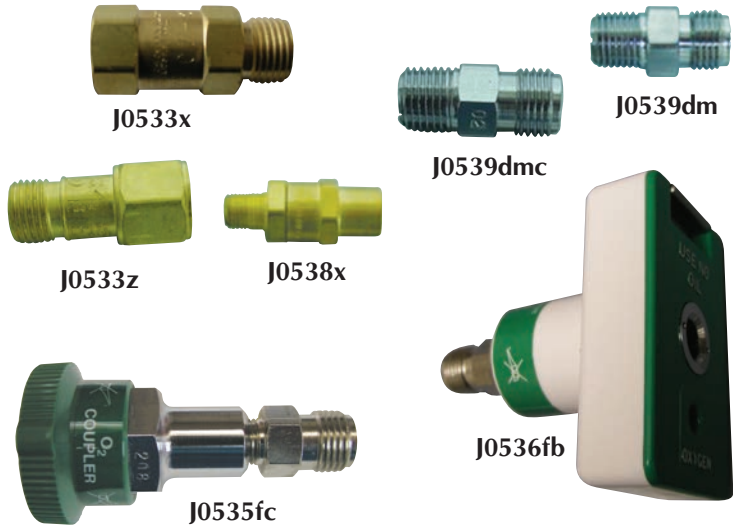

**Oxygen Fittings.** These are double end connectors that allow connecting one pattern of connector to a DISS connector

**Ohio Chemtron**

- J0535fc** Female Ohio to DISS male
- J0536fb** Female Chemtron to DISS male
- J0535fb** Female Ohio to DISS female
- J0536fc** Female Chemtron to DISS female
- J0535b** Male Ohio to DISS male
- J0536b** Male Chemtron to DISS male
- J0535c** Male Ohio to DISS female
- J0536ba** Male Chemtron to DISS female - not pictured

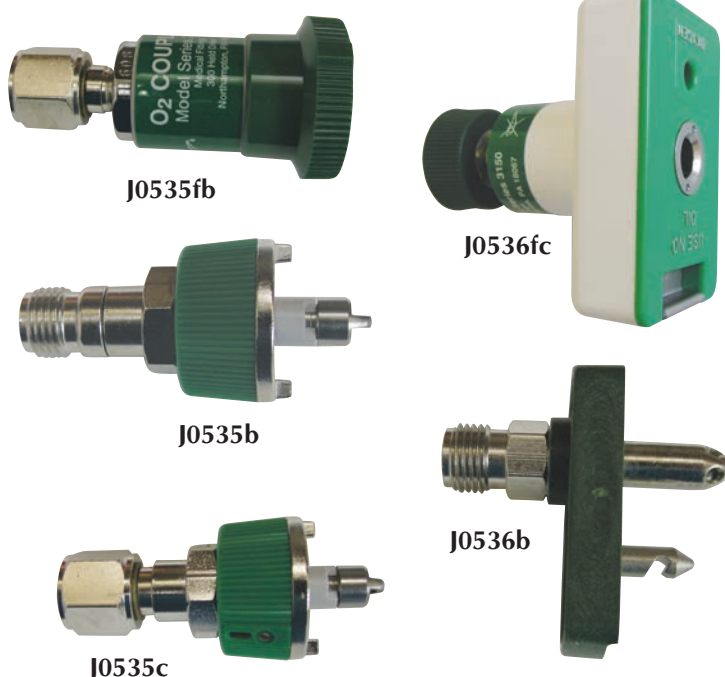

**Wye Adapter.** Connects two machines or hoses to one outlet

- J0537d** female DISS (hand tight) with two male DISS connectors with check valves.
- J0537** One male Ohio with two female Ohio
- J0537a** One male Ohio with two female DISS
- J0537c** Chemtron male quick connect with two female Chemtron connects.
- J0537e** Female Ohio with two female DISS hand tight (not pictured)

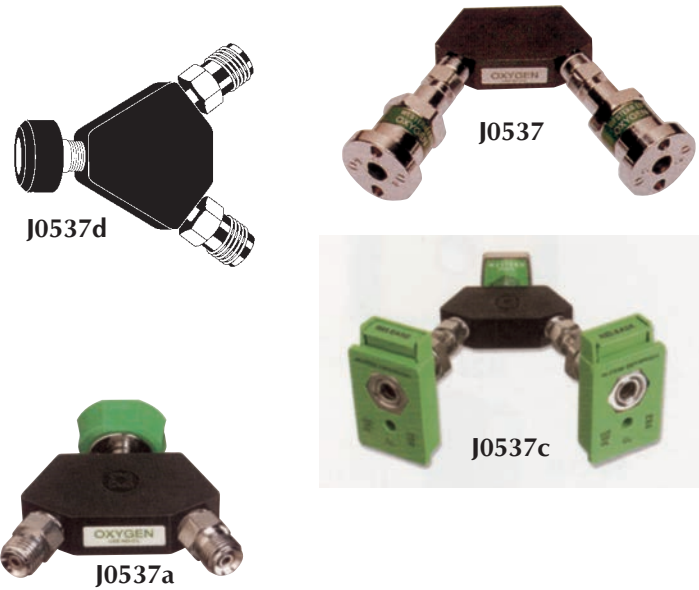



Ohio Style J0537 DISS Style

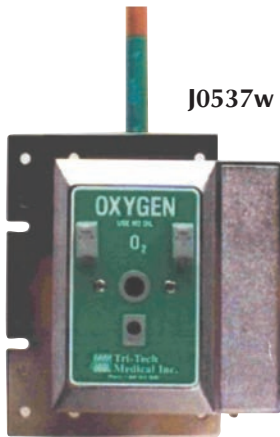

J0537w



"Ganged" wall outlets



J0530vr

**Wall Mount.** Two types:

- Recessed: Fit flush with wall similar to electrical outlet
- Surface: Placed outside the wall

**J0537q Ohio Female Quick Disconnect.** Recessed.

**J0537r Male DISS.** Recessed.

**J0537s Male DISS.** Surface.

**J0537t Ohio Female Quick Disconnect.** Surface.

**J0537v Male DISS Ceiling Outlet.**

**J0537w Chemtron female, wall recessed, quick disconnect,** similar to J0537q, but Chemtron style, not Ohio-style.

"Ganging" medical gas outlets has been done in human hospitals for many years. Now veterinarians are adding more gas and vacuum uses in their hospitals.

In addition to our oxygen outlets, you can order nitrous oxide, vacuum suction, and nitrogen outlets. They are ordered individually — this is the outcome when they are "ganged" together.

**J0537nswc Nitrous Oxide recessed wall outlets, Chemtron**

**J0537nsc Nitrous Oxide ceiling outlet, DISS**

**J0537avd Vacuum suction ceiling outlet, DISS**

**J0537vac Vacuum suction wall outlet, Chemtron**

**J0537nw Nitrogen recessed wall outlet, DISS**

**J0537nc Nitrogen ceiling outlet, DISS**

**J0533nh Nitrogen dual "H" tank manifold**

**J0533n Nitrogen regulator for "H" tank**

Hoses and connectors are available, call for more information.

**J0530vr Vacuum/Suction Regulator** for central vacuum/suction outlet with Chemtron connection. Use with **J-537vac** shown above.

**J0533 Nitrogen regulator for "H" tank.**

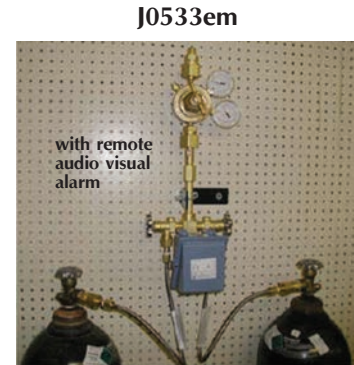
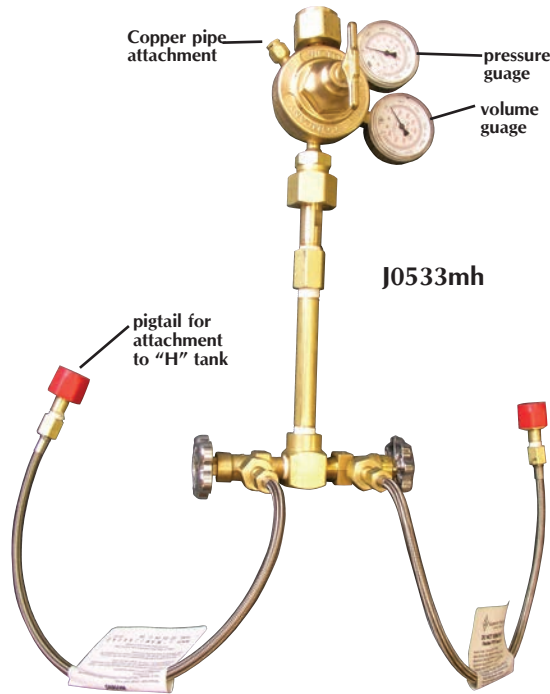
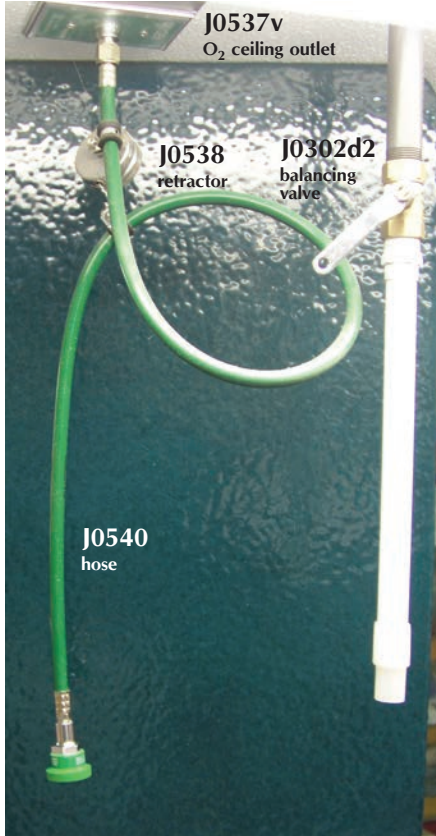

**J0533mh Central Oxygen Supply.** This dual tank manifold allows delivery of oxygen throughout the hospital or clinic via wall outlets or ceiling drops. The system consists of two pigtail hoses that connect to the 'H' tanks. Regulator and volume gauges are included. Then copper pipe (not provided) is plumbed to areas of the hospital requiring oxygen. The unit is wall mounted. Also compatible with "M" tanks.

*These three items are sold together:*

**J0533em Oxygen Dual Manifold** with switch port. Required pressure switch and alarm.

**J0533ps Single setting pressure switch.** Senses drop in pressure—triggers alarm.

**J0533av Remote Audio-visual alarm.** This alarm both emits an audible alarm and a blinking signal when the oxygen pressure drops too low. Can be away from tank.

*The above products are needed for the remote alarm system.*

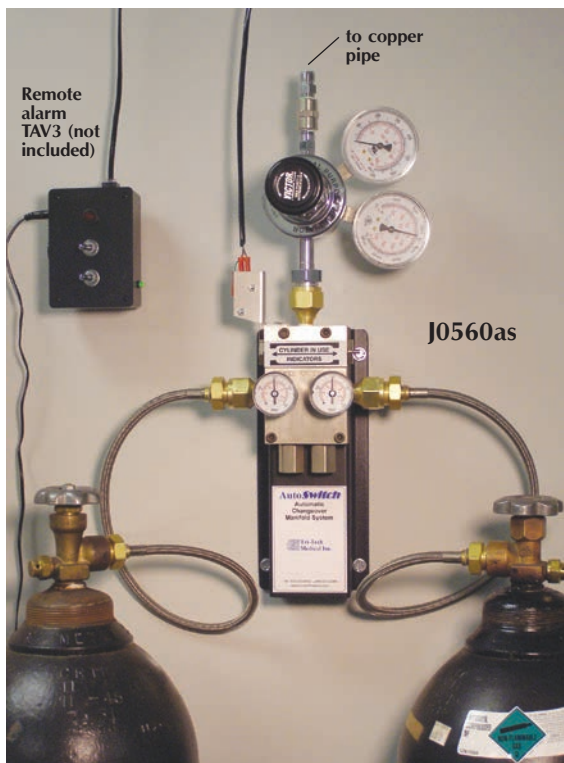

**J0538 Oxygen hose retractor.** This little pool size device attaches on to a ceiling oxygen mounted oxygen hose. It allows the hose to be pulled down when desired and then retracted up and out of the way when not in use. Fits any oxygen hose.

**J0560as Dual Tank Auto Switch** manifold automatically switches from one tank to the other when the tank is empty. TAV3 alarm system available for remote alarm. Manifolds also available 2x2 and 3x3. "H" tanks.

**J0533tav Remote audio-visual alarm** only for auto-switch manifolds.

**J0533zv Oxygen zone valve in box with window.**

**J0533sv Oxygen shutoff valve with locking handle.**

*Both valves available for all gases.*

MANIFOLDS AVAILABLE FOR ALL GASES.



**Cylinder Connection.**

- J0541** **Pin Indexed Yoke.** Oxygen only. (not pictured)
- J0533** **Single Step Oxygen Regulator.** Pressure regulator for large H type oxygen cylinder.
  - Male DISS outlet
  - Preset standard 50 psi outlet pressure
  - 0–4000 PSI high pressure gauge indicates remaining cylinder contents

**J0533a** **Pressure Regulator** for large H-type oxygen cylinder with addition of flowmeter 0–15 liters-per-minute. Also has pressure gauge indicating remaining cylinder contents.

**J0533e** **Pressure Regulator** for E-type cylinder with pin indexed yoke and male DISS connector. Also has pressure gauge indicating remaining cylinder contents.

**J0533ef** **Pressure Regulator** for E-type cylinder with pin indexed yoke, attached flowmeter 0–15 liters-per-minute, and male DISS connector.

**Oxygen Flowmeter.**

- Clearly marked with large numbers
- Designed for accuracy and durability
- Chrome body
- Standard DISS fittings

- J0534a** **Flowmeter.** 0–3 liters-per-minute.
- J0534b** **Flowmeter.** 0–5 liters-per-minute.
- J0534bq** **Flowmeter.** (0–5 liters-per-minute) with quick release Ohio male inflow Male DISS oxygen outflow.
- J0534c** **Flowmeter.** 0–15 liters-per-minute.
- J0534d** **Flowmeter.** 0–1 liters-per-minute. Low flow.

**J0534ec** **Ceiling style Ohio male quick connect with clic style flow meter 0-15 LPM.** Many ceiling drops and wall outlets can be connected and a flow meter easily setup. Outlet end is a male DISS fitting. Possible connections include **(J0655)** clear oxygen tubing.

**J0534ew** **Chemtron male connect with dial flowmeter 1-15 LPM.** Outlet end is a male DISS fitting.

**J0534efm** **Wall style Quick release female DISS flowmeter,** can hook right to male DISS i.e. 'H' tank regulator. Dial flowmeter 1-15 LPM. Outlet end is a male DISS fitting.

**J0534ea** **Wall style Ohio male quick connect with male DISS 1-15 LPM.**

**J0686r** **Clic style regulator** for "E" Yoke head, 0-15LPM dial with nipple for clear O<sub>2</sub> line. **(J0655)**

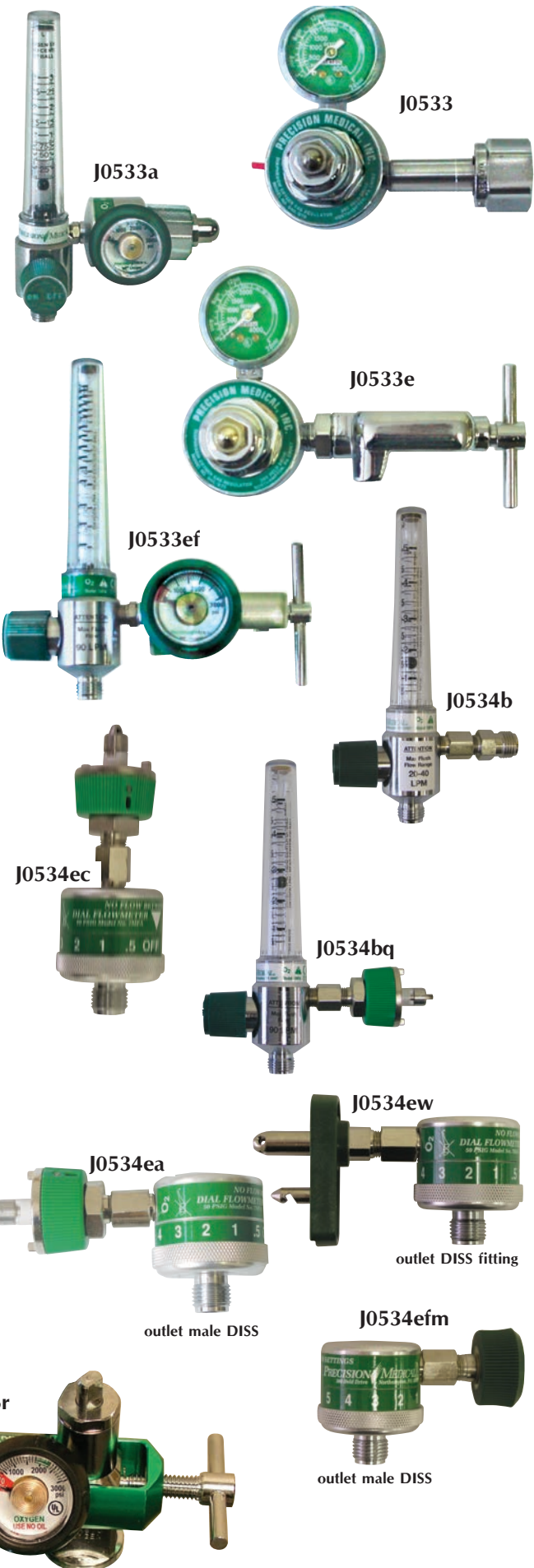

**Anesthesia Hose Adaptor/Connector Sizing.**

- Anesthesia hose. 22mm i.d.
- Scavenger hose. 19mm i.d.
- Pop-off valve. 19mm o.d.
- Endotrach tube connector. 15mm o.d.

**J0595 Anesthesia Hose Connector.** Dual fitting polypropylene. Both ends 22mm/15mm x 22mm/19mm. 2/pkg.

**J0595a Anesthesia Hose Connector.** Dual fitting polypropylene. Ends 22mm o.d. x 15mm o.d. 2/pkg.

**J0595b Anesthesia Hose Connector.** Dual fitting polypropylene. 15mm i.d. x 19mm o.d. x 22mm i.d. 2/pkg.

**J0595c Christmas Tree Swivel Connector.** Dual fitting polypropylene. One end is a female DISS connector the other a barbed connector. One suggested use is from oxygen regulator connecting oxygen tubing to resuscitator bag. 2/pkg.

**J0595d Anesthesia Hose Adaptor.** 22mm i.d. x 22mm o.d. 2/pk.

**J0595e Anesthesia Elbow Connector.** 2/pk.

**J0298mv Mask Valve.** Stop anesthesia gas. This handy valve allows the fresh gas to be shut off when not needed. Fits inline between mask or endotrach tube and anesthesia circuit. Especially useful when using anesthesia mask.

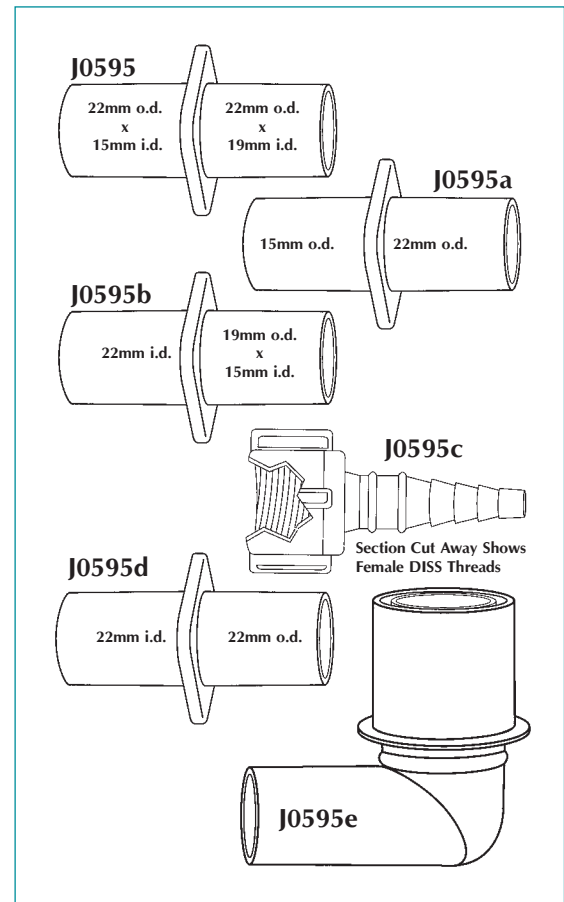

**Humidification Management Exchanger (HME).**

In human anesthesia the prevention of moisture and heat loss is a critical consideration. The smaller patient is especially a concern because hypothermia is more likely to occur. Humidification management exchangers are routinely used in human anesthesia.

Veterinarians are starting to recognize the value of these products and make them part of their anesthetic regime.

The Humid-Vent is a compact connector that is a heat and moisture exchanger. They are placed in the breathing circuit between the "Y" piece (or "T" piece for non-rebreathing) and the endotracheal tube. Inside the connector is a special medium consisting of hygroscopic, naturally absorbent microwell paper. The Humid-Vent can be used up to 24 hours. After 24 hours they lose their effectiveness and must be replaced. In veterinary use they are typically replaced weekly. 5/box.

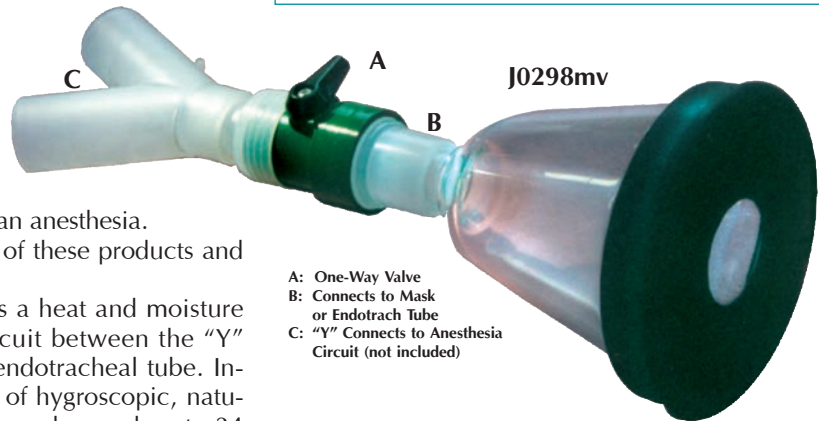

	Use For	Dead Space	Tidal Volume	Maximum Resistance
<b>J0606 Humid-Vent Mini.</b>	0-11#	2.4ml	10-50ml	1.2cm H <sub>2</sub> O @ 7 lpm
<b>J0606a Humid-Vent1.</b>	11-75#	10.0ml	50-600ml	0.3cm H <sub>2</sub> O @ 20 lpm
<b>J0606b Humid-Vent2.</b>	over 75#	25ml	150-1500ml	0.2cm H <sub>2</sub> O @ 20 lpm



## Easy Flow

### Combo Anesthesia Machine with an O<sub>2</sub> Concentrator

**Air is free, oxygen is not! Oxygen is expensive:** The cost of oxygen continues to climb sharply including tank rental, delivery, and hazmat charges. Does your clinic know its oxygen costs every month?

**Easy Flow** can pay for itself in no time! The overall cost of oxygen is high and climbing. The **Easy Flow** offers a great return on investment in as little as one year. A typical clinic doing 4 hours of surgery a day for a five day week with an average flow rate of 2LPM is using approximately 125,000 liter of oxygen per year.

#### Anesthesia Machine

- Performance for a high standard of care with economic initial investment.
- Ready to go with O<sub>2</sub> regulators and system hoses.
- Adult and pediatric circuits with breathing bags.
- Convenient handle for transport
- 5 large locking caster wheels
- Works with all types of vaporizers

**J0559acem Easy Flow Anesthesia Machine** with mounting base 'E' yoke and hoses. There is a continuous supply of medical grade 90%-95% pure O<sub>2</sub> from a 5 liter/min oxygen concentrator. Reserve O<sub>2</sub> supply from O<sub>2</sub> 'E' tank. Toggle back and forth with the flip of a switch. Very quiet O<sub>2</sub> production from room air. O<sub>2</sub> concentrator mounted on leg base of machine for portability and convenience. **(Does not include vaporizer.)**

#### Includes:

- **J0559 Anesthesia machine**
- **J0559ct Concentrator shelf**
- **J0744em Concentrator**, 5 liter
- E-Tank yoke, single
- 3-way control valve
- Anesthesia circuit (**J0248f** and **J0248g**)

**J0744em Easy Flow 5 liter/minute oxygen concentrator.** Self-contained Oxygen Supply. 3 year limited warranty.

- Length 17.1 in (43.5 cm)
- Width 12.3 in (31.1 cm)
- Height 17.0 in (43.2 cm)
- Weight 29.6 lbs (13.4 kg)

Includes **J0533x** check valve.

**J0558nace JorVet Anesthesia Plus Machine** with mounting base 'E' yoke and hoses. (Does not include vaporizer.)

#### Includes:

- **J0558n**
- **J0559ct Concentrator shelf**
- **J0744em Concentrator**, 5 liter
- E-Tank yoke, single
- 3-way control valve
- Anesthesia circuit (**J0248g** and **J0248f**)

**J0558nac JorVet Anesthesia Plus Machine** with mounting base 'E' yoke and hoses. More shelf space - not shown with hoses and 'E' yoke attached.

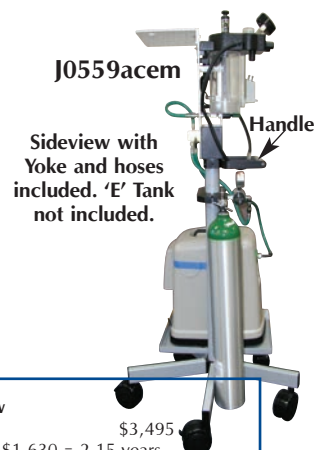
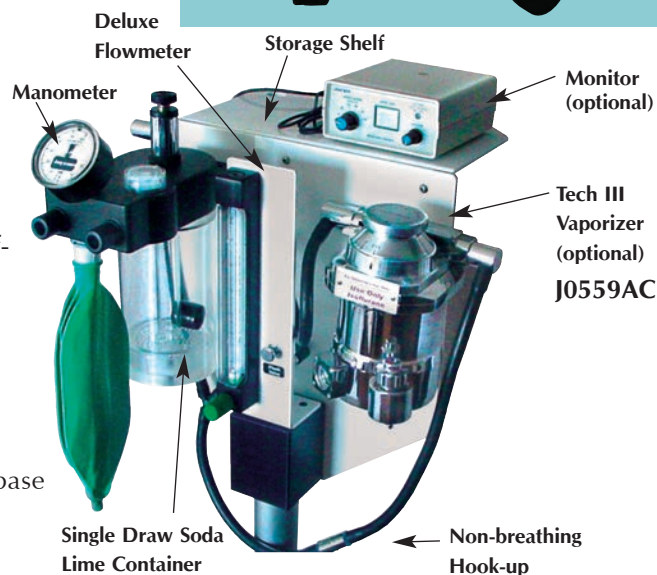

'E' Tanks		= Easy Flow	'H' Tanks	
E tank volume	425 liters	MSRP	H tank volume	6,900 liters
Tanks per year	295	\$3,495	Tanks per year	18
Refill per tank	\$20.00	\$3,495 + \$5,900 = 0.6 years	Refill & delivery	\$85.00/each
Total	\$5,900	Includes anesthesia machine! (Does not include vaporizer)	Tank rental	\$100/total
			Total	\$1,630

'E' Tanks		= Easy Flow	'H' Tanks	
E tank volume	425 liters	MSRP	H tank volume	6,900 liters
Tanks per year	295	\$3,495	Tanks per year	18
Refill per tank	\$20.00	\$3,495 + \$1,630 = 2.15 years	Refill & delivery	\$85.00/each
Total	\$5,900	Includes anesthesia machine! (Does not include vaporizer)	Tank rental	\$100/total
			Total	\$1,630



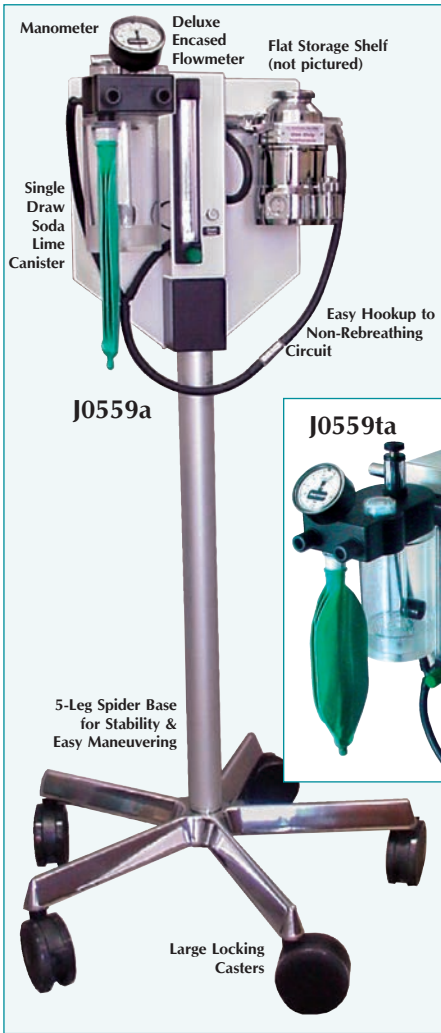

**Small Animal Jorvet Anesthesia System.** Performance for a high standard of care with economy of initial investment.

- Precise machined fittings for an airtight connection
- Powder coat finish is attractive and easy to clean
- Available in mobile stand or table top models
- Protected, enclosed flowmeter with 200cc–4 lpm setting
- Will accept most precision vaporizers
- Integrated O<sub>2</sub> flush valve set at 15 lpm
- Soda lime canister is protect by its location under block. Smaller size, 970cc, versus standard 1300cc. Also quick turn knob for each change of exhausted soda lime

- Includes two anesthesia circuits, universal “F” circuit and non-breathing circuit
- Manometer pressure gauge for proper bagging of animal
- Pop-off valve attaches to a standard scavenger unit



**Table Top Unit.** On any flat surface unit swivels in various positions.

**J0559** Jorvet Mobile Unit without vaporizer.

**J0559t** Table Top Unit without vaporizer.

**J0559wb** Wallmount Anesthesia Machine with Drager Vaporizer

**J0559w** Wall Mount Anesthetic Machine.

**J0560e** Double “E” Tank Cylinder Mounting Yoke.

**J0562m** Isoflurane Tec III Style Precision Vaporizer or

**J0562p** Sevoflurane Tec III Style Precision Vaporizer

*NOTE: Special rates are availale. Please call technical support for information on anesthesia and vaporizer combinations.*

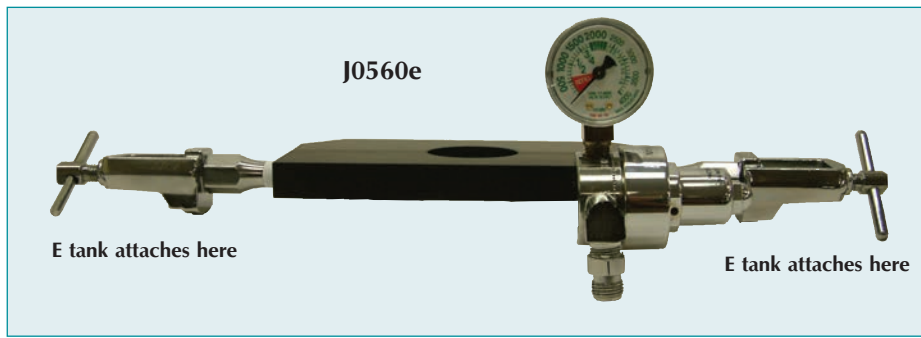

**Wall mount with swing out arm extension.** This unit mounts to the wall but can swing out via a metal mounting arm.

**J0559ws** Swing out wall anesthesia machine without vaporizer

**J0559wsb** With Drager refurbished isoflurane vaporizer

**JorVet Soda Lime. Carbon dioxide absorbent granules.** JorVet soda lime is a high-grade granular product that effectively absorbs carbon dioxide that is produced as an anesthesia by-product. It is a mixture of calcium hydroxide  $\text{Ca}(\text{OH})_2$  also known as lime plus a smaller amount of sodium hydroxide  $\text{NaOH}$ . Upon exposure to carbon dioxide  $\text{CO}_2$ , the calcium hydroxide converts to calcium carbonate  $\text{Ca}(\text{CO}_3)$ . This prevents  $\text{CO}_2$  buildup in a re-breathing circuit. The sodium hydroxide acts as a catalyst in the process. No potassium hydroxide ( $\text{KOH}$ ) is present in JorVet soda lime; this helps to avoid the formation of toxic compounds such as Compound A and carbon monoxide.

JorVet soda lime has a pH color change indicator that changes from white to violet when the soda lime needs to be changed. It will eventually return to its original color if not changed. Therefore, a good rule of thumb is to replace the soda lime every time the vaporizer is filled.

- J0553** 3lb (1.36kg) Foil lined bag  
**J0553b** 5-gallon container
- Minimal dust
  - No KOH-minimizing chance of anesthetic reactions that produce toxins
  - Irregular particle size-creates more surface area
  - Saturation indicator built-in changes from white to violet
  - Particle size 4-8 USP Mesh (2.5mm-5mm)

Soda Lime Cannisters. Prefilled canister is preferred by many clinics. Comparable with other brands of canister – identical in size and weight. JorVet now offers an entire range of soda lime products

- J0553c** **Prefilled.** 920 grams.

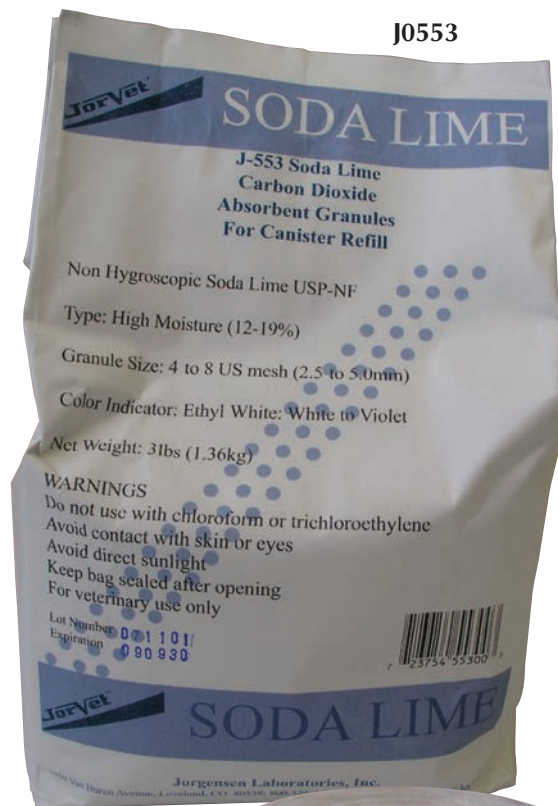

J0553



J0553c

**Anesthesia Vaporizer Cleaning and Calibration.** Veterinarians take pride in practicing quality preventive medicine. Your anesthetic vaporizer requires that same preventive maintenance as well. Every manufacturer of vaporizers recommends periodic cleaning and a calibration check for precision temperature compensated vaporizers. This precision instrument has a number of moving parts such as a thermostat, rotary valves and fiber wicks. All are enclosed out of sight in a steel cylinder. With heavy use over time the delivery system cannot be relied on to be totally accurate.

JorVet offers a service department that has over 45 years of total experience in servicing vaporizers.

**JorVet Vaporizer Service** includes:

- Replacement of all seals
- Replacement of wick
- Computerized laser refractometer used to ensure dial settings
- 48 hour turnaround (not including transport time)
- Return delivery costs included

Why wait for an anesthetic “incident” before deciding upon a cleaning and calibration checkup for your vaporizer?

**Standard Service:** Calibration and Cleaning of Your Vaporizer. You send it to JorVet and we return that same vaporizer. Loaners available.

Also available: Conversion to Sevoflurane

*NOTE: All vaporizer service is handled directly by JorVet, not through the distributor.*

**Standard Service.**

- J0561s** Ohio Vaporizer.
- J0561bs** Tec III Vaporizer.
- J0561as** Tec IV Vaporizer.
- J0561xs** Tec V Vaporizer.
- J0562ds** Drager Vaporizer.

**Gas Conversions (Halothane to Isoflurane).** Want to convert your halothane vaporizer to an isoflurane vaporizer? The same choices on service are offered.

- J0561bc** Tec III Vaporizer.
- J0561ac** Tec IV Vaporizer.
- J0561sc** Ohio Vaporizer.
- J0562dc** Drager

**NEW**

**Tec III Style Precision Vaporizer.**

Features precision delivery and temperature compensation.

- **10 YEAR LIMITED WARRANTY!**
- Brand new: NOT refurbished
- New light weight – 9lbs vs. 18lbs standard
- Mounts to any anesthesia machine
- 125cc capacity
- Standard funnel fill

**J0562m Isoflurane Vaporizer.**

**J0562p Sevoflurane Vaporizer.**

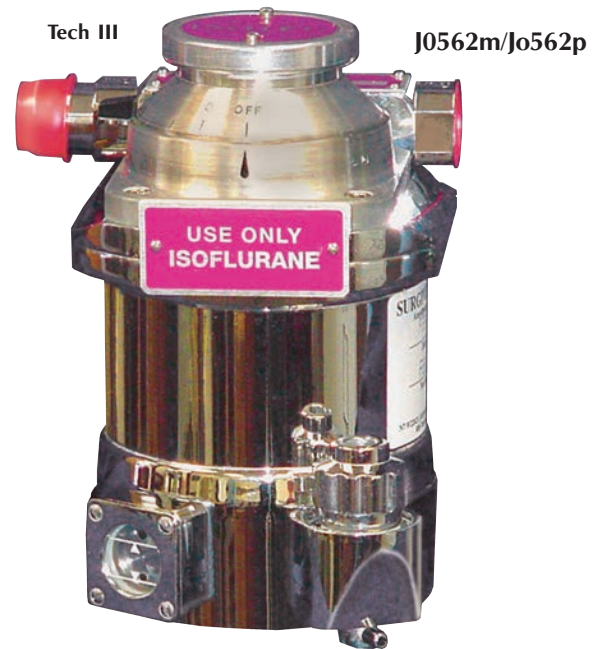

**J0562d North American Drager** refurbished isoflurane vaporizer. These temperature compensated precision vaporizers have enjoyed wide-spread use in human hospitals. JorVet is offering fully refurbished units that fit standard veterinary anesthesia machines. Three-year warranty included. 200cc capacity.

**J0562e Drager Sevoflurane Refurbished Vaporizer.** Large 200cc capacity.







J0559d3

**J0559d3 Pop-Off Valve Restrictor.** The restrictor is placed on the pop-off valve exhaust port and the scavenge tubing is attached to the other end. The button on the device top is depressed to close the exhaust, thus allowing the bagging of the animal. The restrictor allows the anesthetist to leave the pop-off valve open, but the animal still may be bagged when necessary. This prevents the chance that the pop-off valve may be left accidentally closed, a situation which causes high pressure within the system, and can lead to respiratory damage and pneumothorax. Made from Delran, a sturdy, durable material.



J0562

**Anti-Spill Funnel/Adaptor.** This handy adapter screws onto gas agent bottle top and the other end fits snugly into the filling funnel on the gas vaporizer. It makes vaporizer refilling spill free. Color coded for agent type.

**J0562x Isoflurane Funnel/Adaptor.** Purple.

**J0562y Sevoflurane Funnel/Adaptor.** Yellow.

**Oxygen Concentrator.** Oxygen concentrators separate air into primary components such as oxygen and provide the lowest cost mechanism to do so.

The Regalia offers an ideal and innovative system for supplying oxygen to anesthesia machines and for emergency oxygen needs. This concentrator will extract medical grade O<sub>2</sub> directly from the air and deliver it to a desired location.

The digital flow rate meter delivers 1-10 lpm of continuous O<sub>2</sub>. If the flow meter rate is set at 1 lpm it will deliver a 95 percent O<sub>2</sub> concentration, 5 lpm will deliver 90 percent concentration.

Made specifically for the veterinary market.

#### Features:

- Reliable O<sub>2</sub> production with constant delivery pressure
- Eliminates need for O<sub>2</sub> tank
- Compact, lightweight, yet rugged environmentally tolerant design
- Quiet operation
- Easy-to-read digital flow meter
- Control knobs are large and easily accessible
- Self cleaning, minimal maintenance
- Low operating cost, 5 watt power consumption
- 14.7"W x 26"H x 10.1"D. 54 lbs. (24 Kg)
- Three-year warranty

#### Performance:

- Flow rate: variable 1/2-10 lpm (**J0744a**)
- O<sub>2</sub> pressure 5 psi (37.9 Kpa) minimum
- O<sub>2</sub> Concentration 95-92 percent at 0-3 lpm  
95-90 percent at 3-5 lpm
- Designed for anesthesia machines, 2 maximum.

**J0744a Oxygen Concentrator,** with 0-10 lpm flow rate.



J0744a

**JorVet Anesthesia Plus.** Deluxe version of the standard JorVet Anesthesia machine.

- Plenty of shelves, powdered coated x-ray steel 9" width x 24" long
- Lower shelf 12" x 24" long for storing patient monitors, electrosurgery unit or any other equipment
- Plenty of room for extra vaporizer or additional flowmeter
- Handle for stability when moving
- Room for e tank yoke
- Large locking casters for easy and smooth motion

Includes universal F anesthesia circuit

- 3 liter breathing bag
- Non rebreathing anesthesia circuit

- J0558n** Without vaporizer
- J0558na** With Tech IV refurbished isoflurane or choose from new and refurbished sevoflurane vaporizers



**Vapor Wand.** Veterinarians often treat ferocious or vicious animals such as aggressive cats and dogs, small zoo animals, wildlife, primates, reptiles, and other exotic species. For proper examination or surgery, these animals need to be anesthetized. Older methods such as pole syringes and darts are high risk to both the animal and the veterinarian. Anesthesia chambers have size limitations, and transferring the patient safely into chambers can be risky.

The development of anesthetic agents such as isoflurane can make induction faster, quieter, and safer. David S. Hodgson DVM, DACVA at Kansas State University Veterinary Teaching Hospital, developed the innovative Vapor Wand to deliver anesthetic vapors into enclosed cages and pet carriers.

The Vapor Wand is a small round stainless steel vented probe with a cotton wick. It is attached to a 400ml air pump. When a pre-measured dose of liquid isoflurane is added to the wick, and the air pump is cycled, the liquid isoflurane is vaporized. Any animal may be quickly anesthetized by use of the Vapor Wand inserted into the sealed environment. The example shown is a transport kennel placed into a plastic bag. The Vapor Wand is inserted into the kennel and the air pump is cycled. The round viewing window allows for observation of the animal during induction of anesthesia. When induction is complete, the bag is opened. The animal may be maintained via mask or other anesthetic techniques.

- J0990** **Vapor Wand Kit.** Includes:
  - Vapor wand 32 1/2" L x 3/4" D
  - 400ml reusable syringe
  - Small viewing port with window
  - Laminated dosage calibration chart
  - Instructional CD-ROM

**J0990c** **Instructional CD.**

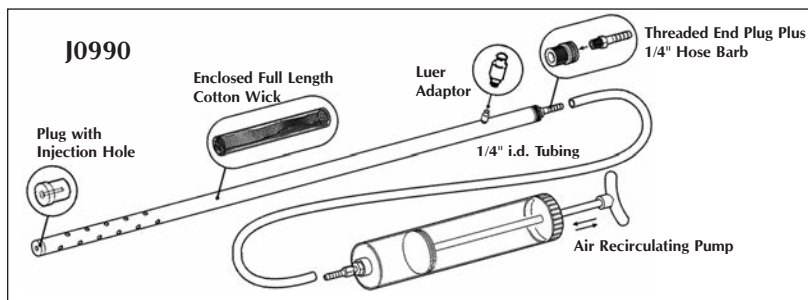





Zipper Encircles Entire Lid



Adjustable Nylon Fabric Collar with Drawstrings

Nasal Cannula

Humidifier

**Oxy Hood, Oxygen Supplementation Device.** The challenge of delivering oxygen to an animal in respiratory distress is difficult in most veterinary clinical situations. An oxygen cage or an ICU unit is an expense beyond the budget of most clinics. The hand held use of anesthesia masks or nasal cannula is stressful to the animal and labor intensive.

The Oxy Hood was developed to deliver oxygen in a less restrictive and stressful environment. The Oxy Hood uses the conventional cone shape of an Elizabethan collar and adds a clear plastic "lid" over the end. Numerous vent holes throughout the cone allows the excess gas to vent. Oxygen is provided to the Oxy Hood via a nasal cannula attached to the hood. The oxygen source uses a bubble humidifier to prevent drying of the respiratory tract.

**Features:**

- Collar is sewn to nylon fabric with a drawstring, plus velcro attachment allows for proper neck sizing
- Lid, or face of unit is attached with zipper
- Clear plastic material is used throughout for better observation and for the animal to see clearly
- Four sets of holes die cut to allow ventilation of carbon dioxide and to maintain the oxygen level at more than 60 percent
- Very small animals can be placed totally in the larger Oxy Hood like an oxygen tent
- Complete with humidifier, oxygen nasal cannula, and oxygen tubing



J0652a



J0654



J0653



J0655

- J0652a Oxy Hood.** Small. Cats and dogs 15 lbs .
- J0652b Oxy Hood.** Medium. Animals 15-30 lbs.
- J0652c Oxy Hood.** Large. Animals 30-60 lbs.
- J0652s Oxy Hood.** Set of all 3 sizes.
- J0653 Humidifier.** This device works by oxygen bubbling through a diffuser in a fluid.
- J0654 Oxygen Nasal Cannula.** This clear tubing delivers oxygen via small plastic tubing to two outlets designed to lay just outside the nares. With universal female connector (i.e. will fit DISS fitting of a flowmeter). 7'. 4/pk.
- J0655 Oxygen Tubing.** Clear plastic with universal female connectors that can connect to DISS male fittings. 7'. 4/pk.
- J0655L Oxygen Tubing.** 25'. 2/pk.
- J0656 Oxygen Catheter.** Clear plastic catheter with round tip and side ports for intra-nasal oxygen therapy. Connects to oxygen tubing. 16"L x 14fr dia. 4/pk. (not pictured)
- J0656a Oxygen Catheter.** 16"L x 10fr dia. 4/pk. (not pictured)

*NOTE: Connecting Oxy Hood requires an oxygen flowmeter.*

**Recommend:**

- "H" tank, use **J0533a**
- "E" tank use **J0533ef**
- Anesthesia machine flowmeter
- Flowmeter (**J0534b**) attached to humidifier top



**Oxygen Cylinder/Tank Racks and Carts.** Oxygen tanks are cumbersome and top-heavy items. The danger to clinic personnel from a dropped or toppled oxygen tank can be minimized with proper storage and handling. JorVet offers a number of oxygen tank racks and carts to safely handle the common “H” or “E” cylinders used in veterinary facilities. Various regulators and yokes are also available.

**J0686 Single “E” Cylinder Cart.** This cart allows the movement of oxygen throughout the clinic. The cart has an adjustable height handle, soft foam tires, front lifting handle, mask hanger hook, and chrome plate finish. 12”W x 8”L x 39”–44”H. 7½ lbs.

**J0686a Single “E” Cylinder Stand.** Chrome polished circular stand keeps “E” tank safely upright. 9½”D x 4½”H. 7½ lbs.

**J0686b Single “E” Cylinder Mount.** Mounts onto any flat surface. 5”W x 5”L x 16”H. 4 lbs.

**J0687 “H” Cylinder Cart.** Ball bearing wheels (10”) with retractable back dual wheel support. They fold up and away when not in use. Chrome plate steel construction. Secured by locking chain. Perfect for transport and storage of hard to handle “H” tanks. Chain included. 14”W x 20”L x 49”H. 29 lbs.

**J0687a Single “H” Cylinder Stand.** Black wrinkle powder coat. Reversible band holds tanks of varying diameters. 19”W x 12”L x 39”H. 30 lbs.

Tanks not included for above.



**J0686k Portable Oxygen Delivery System.** The need for an emergency oxygen source can arise at any time. A clinic should be adequately prepared with the proper equipment that is made readily available and is stand-alone. Most clinics do not have central oxygen or may have just one oxygen tank that is dedicated to the anesthesia machine. The JorVet portable oxygen delivery system is everything you need just add the oxygen! The system includes:

- “E” oxygen tank with Yoke head—will hold up to 425 liters when full. (J-688)
- Clic style regulator for “E” Yoke head, 0-15LPM dial. (J-686R)
- Light weight wrench for opening/closing oxygen tank regulator. (J-686W)
- Transport cart with 2 wheels that can go anywhere in the clinic. (J-686)
- Clear oxygen tubing 7ft. length (4pk) with a female DISS fitting. (J-655)
- Oxygen catheter 14fr delivers oxygen by nasal insertion or “blow by”. (J-656)
- Connectors: allow connection to standard anesthesia masks.



**Cage mounted oxygen delivery system. Flowmeter with humidifier.** This oxygen delivery system will attach to any cage.

- 15LPM flowmeter
- Bubble humidifier (J0653) add water or saline
- Attaches to cage bars via two "U" bolts or wide flat washers
- Choices of male DISS fitting or male Ohio quick release for oxygen hose connection to flowmeter
- Oxygen tubing 7 ft (J0655)
- Oxygen catheter 14fr (J0656) for nasal insertion or "blow by"



J0953 Male DISS fitting  
 J0953q Male Ohio quick release

**The Buster ICU cage** offers the most affordable intensive care unit available. It can simply fold up into a small nylon bag for storage after use.

- Controlled oxygen therapy nebulization
- Can double as an anesthesia chamber
- Collapsible for daily storage and set up anywhere i.e. standard stainless cage

Specifications on design

- PVC lined for easy cleaning
- Clear vinyl window covers for visualization
- Either warmth or cooling can be provided with reusable gel packs
- Buster Kennel mattress included

Accessories include: oxygen accessory kit (J-1057q)

- 6 color coded Venturi oxygen delivery nozzles
- Small nebulizer
- Connecting T-piece
- Oxygen tubing 7ft (2.1m)



J1057 small exotics, cats, small dogs. 18" w x 13" d x 13" h. 5 liters wt. = 4.6lbs (2.1kgs)  
 J1057a medium. 24" w x 18" d x 18" h. 121 liters  
 J1057b large. 44" w x 26" d x 26" h. 464 liters  
 J1057q Oxygen accessory Kit.



**Buster Kennel Mattress**

- Fits inside Buster ICU cage for soft patient comfort
- Waterproof black nylon cover with zipper
- Can be scrubbed clean then drip dry in minutes
- Withstand most disinfectants
- Includes gel pack that can provide heat (microwave) or cool (refrigerator)
- Gel packs are non-toxic if accidentally consumed

Buster kennel mattress available separately with gel packs

J1058 small. 18" x 12" x 3" thick  
 J1058a medium. 24" x 18" x 3" thick  
 J1058b large. 26" x 24" x 3" thick  
 J1058c x-large. 40" x 26" x 3.2" thick





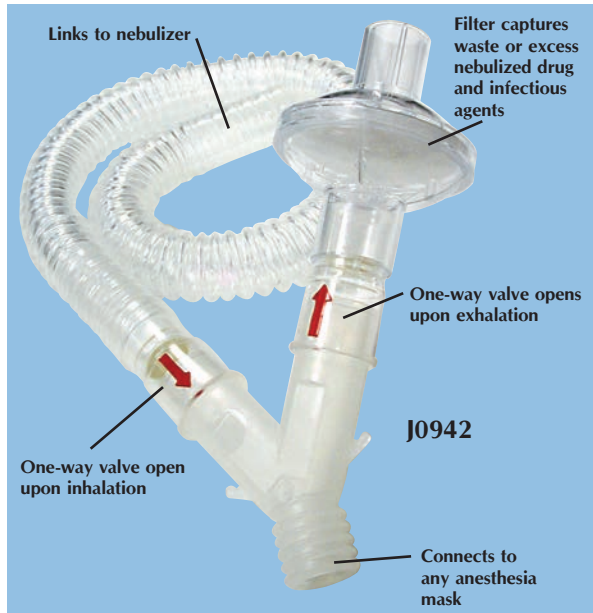

**J0942**

**Canine Ventilator Circuit.** This circuit was designed with the help of a prominent respiratory disease specialist. The circuit was designed to work in conjunction with the J-949m Nebulizer pump. Its function is to increase the inhalation percentage and decrease the exhalation or vented product. This is accomplished by: two one-way valves that restrict flow direction and a bacterial filter that traps wasted nebulized drugs. The operator will have less exposure to nebulized drugs.

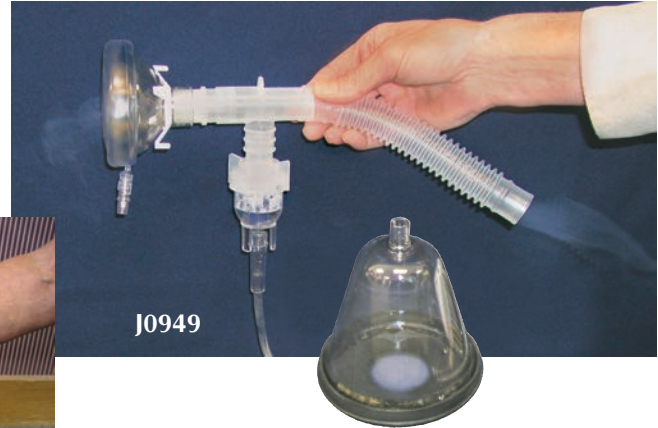

**J0949**

**J0949m**

**Nebulizer Compressor.** Nebulizer compressor unit with complete accessories. Uses room air to power a medicated nebulizer. Takes about 10 minutes. Mask not included. Uses 110V. Size 16.2" x 3.9" x 6.9". Weight 3.5 lbs.



**J0843**

Anodized Aluminum Chamber

**Feline Breathe Easy.** A great aid in treating feline asthma has been improved!

The "Feline Breathe Easy" has been a very popular product in treating feline asthma. The pocket spacer holds a metered dose inhaler (MDI) to deliver medication.

The new pocket spacer is called the Vortex and has three advantages over other plastic pocket spacers:

1. Anodized Aluminum chamber versus plastic. The anodized aluminum is non-electrostatic and delivers more medication from the MDI to the patient.
2. 'Duckbill' shaped valve designed for minimal aspiratory effort, ensures a low loss of medication.
3. Vortex Cyclonic aspiratory flow pattern enhances aerosol delivery.

**J0843**

**Feline Breathe Easy Inhalant Delivery System.**

Complete kit includes two different sized masks. Directions include suggested treatment regimes. Cylinder: 4<sup>3</sup>/<sub>8</sub>"H, 1<sup>3</sup>/<sub>4</sub>" dia., 1.3 oz.



Cyclonic Flow

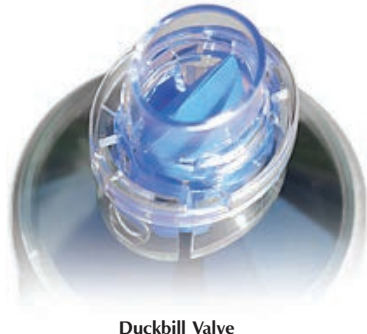

Duckbill Valve

**J0298dd**

**Replacement Mask.** 1" i.d. widest area x 1<sup>3</sup>/<sub>4</sub>" vertical i.d.

**J0298de**

**Replacement Mask.** 1<sup>1</sup>/<sub>4</sub>" i.d. widest area x 1<sup>1</sup>/<sub>4</sub>" vertical i.d.



**Silicone Small Animal Tracheostomy Tubes.** Tracheostomy is an important tool for managing critically ill patients or patients with upper airway obstructions.

A tracheostomy tube can be either placed temporarily (i.e., surgical procedure) or long term (i.e. laryngeal paralysis).

Types of tracheostomy tubes:

1. Most tubes are supplied with an obturator. These aid in insertion and are removed after placement.
2. All tubes have a 15mm connector. This is the same fitting as an endotracheal tube and allows hook-up to an anesthesia hose.
3. All tubes have pliable wings or flanges allowing tying the tube in place with cotton (umbilical) tape or gauze.
4. Tubes are non-cuffed or cuffed (needed when assisting ventilation).
5. Tubes are single lumen cannula.
6. All tubes are 100 percent silicone that softens at body temperature.
7. All cuffed tubes are high volume low pressure and profile.

*NOTE: Tracheostomy tubes are sized by their i.d.  
Tubes should be ~50% of the tracheal lumen width.  
The trachea changes diameter during the respiratory cycle.  
The tracheal body is wider than the larynx.*

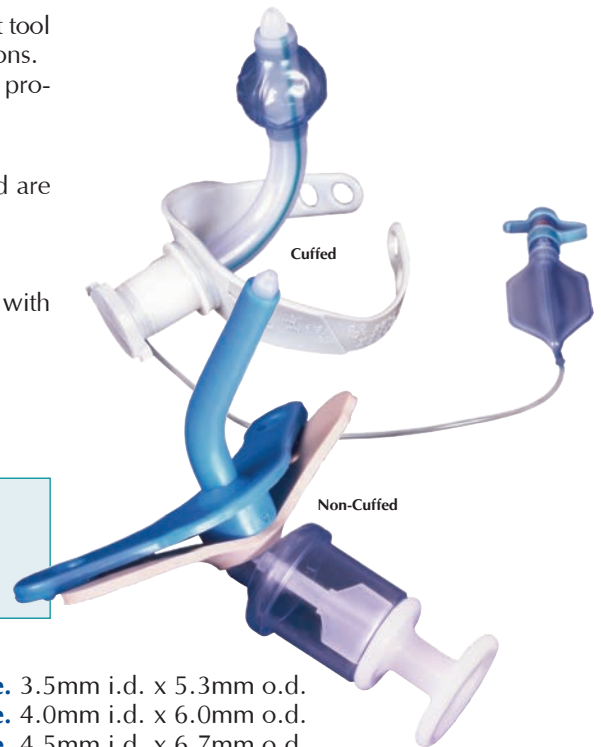

**Single Lumen Uncuffed Pediatric Tube.**

- \*J0690a Tube. 2.5mm i.d. x 4.0mm o.d.
- \*J0690b Tube. 3.0mm i.d. x 4.7mm o.d.
- \*J0690c Tube. 3.5mm i.d. x 5.3mm o.d.
- \*J0690d Tube. 4.0mm i.d. x 6.0mm o.d.
- \*J0690e Tube. 4.5mm i.d. x 6.7mm o.d.
- J0690f Tube. 5.0mm i.d. x 7.3mm o.d.
- J0690g Tube. 5.5mm i.d. x 8.0mm o.d.

**Uncuffed Tube.**

- J-690h Tube. 6.0mm i.d. x 8.7mm o.d.
- J-690j Tube. 7.0mm i.d. x 10.0mm o.d.
- J-690k Tube. 8.0mm i.d. x 11.3mm o.d.
- J-690m Tube. 9.0mm i.d. x 12.7mm o.d.

**Cuffed Tube.**

- \*J0691a Tube. 3.5mm i.d. x 5.3mm o.d.
- \*J0691b Tube. 4.0mm i.d. x 6.0mm o.d.
- \*J0691c Tube. 4.5mm i.d. x 6.7mm o.d.
- J0691d Tube. 5.0mm i.d. x 7.3mm o.d.
- J0691e Tube. 5.5mm i.d. x 8.0mm o.d.
- J0691f Tube. 6.0mm i.d. x 8.7mm o.d.
- J0691g Tube. 7.0mm i.d. x 10.0mm o.d.
- J0691h Tube. 8.0mm i.d. x 11.3mm o.d.
- J0691j Tube. 9.0mm i.d. x 12.7mm o.d.

\* No Obturator Available.

**Silver-Plated Metal Tracheostomy Tube 3-Piece Kit.** German-made. Kit includes:

- Bulb shaped obturator
- Inner cannula for easy cleaning
- Outer cannula with wide outer plate for secure attachment (i.e., umbilical tape)

- J0143a 3-Piece Kit. 4mm o.d.
- J0143b 3-Piece Kit. 8mm o.d.
- J0143c 3-Piece Kit. 10mm o.d.
- J0143d 3-Piece Kit. 12mm o.d.



**Silicone Equine Tracheostomy Tube.** Silicone softens at body temperature for patient comfort. Balloon inflates via one-way valve. The universal attachment fits large animal anesthesia machine and ventilator hoses. Has a wide outer flexible plate for secure attachment (i.e., umbilical tape)

- J0692a Tube. 12.0mm i.d. has 15mm connector/no balloon
- J0692b Tube. 15.0mm i.d.
- J0692 Tube. 20.0mm i.d.
- J0692d Tube. 25.0mm i.d.

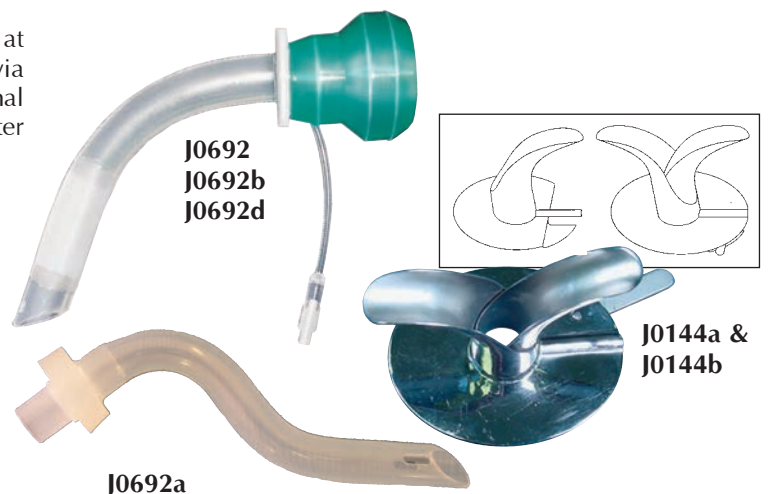

**Tracheotomy Tube.** Pape's model. Nickel-plated brass. Self retaining.

- J0144a Tube. 18mm i.d. 22mm o.d.
- J0144b Tube. 22mm i.d. 28mm o.d.

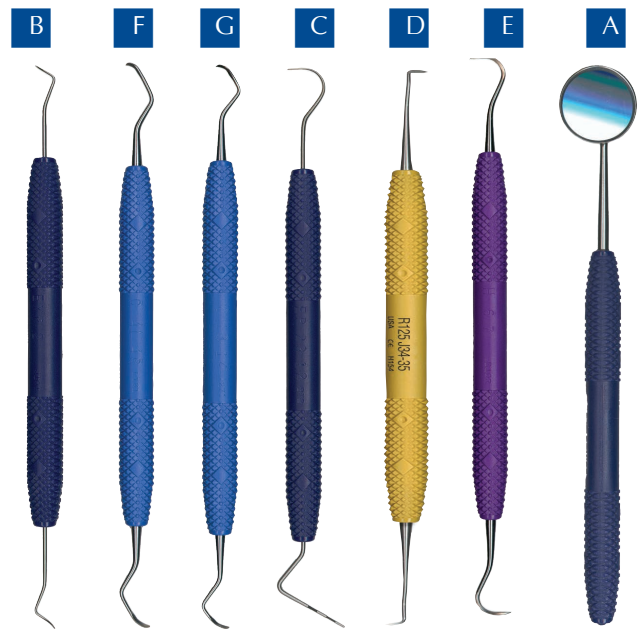
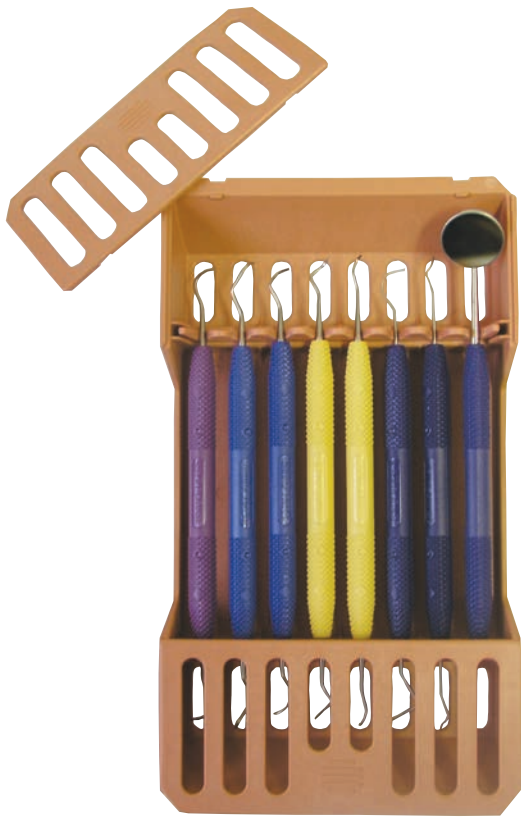

Cryogenically-treated 440A-USA stainless steel is guaranteed harder, tougher and will hold its edge 2-7 times longer than competitor's.

Ultra-light solid resin handle for the greatest tactile sensitivity you may ever experience.

Exclusive extended knurling pattern gives you maximum control for leverage as well as torque.



Ultra-large handle for premium comfort combined with the light weight instrument reduces risk of Carpel Tunnel Syndrome

Anatomically color-coded to speed up set-ups and pick-ups.

**J0973n Small Animal Prophy Kit** contains all the instruments needed for doing the proper dental examination and cleaning hard to reach areas. Each instrument is color coded for easy identification.

Kit Includes:

- A J-973an Mirror #4.** Diagnostic: visual inspection.
- B J-973bn Explorer #2.** Diagnostic: caries and calculus detection, exploration of pocket characteristics.
- C J-973cn Explorer/Probe 23/12.** Diagnostic: explorer/probe combination, dental examinations and charting.
- D J-973dn Jacquette 2s-3s.** Universal scaler: sickle scaler for supragingival on posterior surfaces.
- E J-973en Jacquette 6s-7s.** Universal Scaler: thin contra-angle scaler with offset bend for interproximal areas and anterior surfaces.
- F J-973fn Columbia 4r-4L.** Universal Curette: posterior application curette with two cutting edges and rounded toe for use on all surfaces.
- G J-973gn Columbia 13-14.** Universal Curette: application curette with two cutting edges and rounded toe for use on all surfaces.
- H J-973h Sterilization Cassette Tray** useful for sterilizing and for storage between procedures.

*NOTE: Instruments available in prophy kit or individually.*



J0042a

**J0042a Canine Tartar Scraper.** Triangular. Stainless steel. 5<sup>3</sup>/<sub>4</sub>".



J0042b

**J0042b Canine Tartar Scraper.** Double-end curved ends with angular edges. Stainless steel. 6<sup>3</sup>/<sub>4</sub>".



J0042d

**Dental Forceps** for small animal tooth extraction.

**J0042d Forceps.** 7"L.

**J0042e Forceps.** 7"L.

**J0042f Forceps.** 7"L.

**J0042g Forceps.** 7"L.



J0042e



J0042f



J0042g



J0042j

**J0042j Dental Scaler.** #6. Stainless steel. 6"L.



J0042m

**J0042m Double-Ended Scraper, Probe, and File.** One end has a fine file for smoothing out chips and cracks. The other end has a sharp point to use as an exploring probe and for scraping tartar. Stainless steel. 6".



J0042s

**J0042s Double-Ended Subgingival Curette,** Gracey style. Subgingival curette for important removal of necrotic debris below the gumline. Often overlooked but necessary for proper dental care. England. Stainless steel. 6".



**J0041mi Dental Mirror.** 22mm (7/8") dia.



**J0042q Dental Exploring/Measuring Probe.** The delicate explorer tip is used for increased tactical sensitivity in the gingival sulcus. It locates subgingival calculus and can be used to check tooth mobility. The periodontal measuring probe is graduated in millimeters. It is held parallel to the long axis of the tooth and measures gingival sulcus depth. 6 1/2".

J0041mi

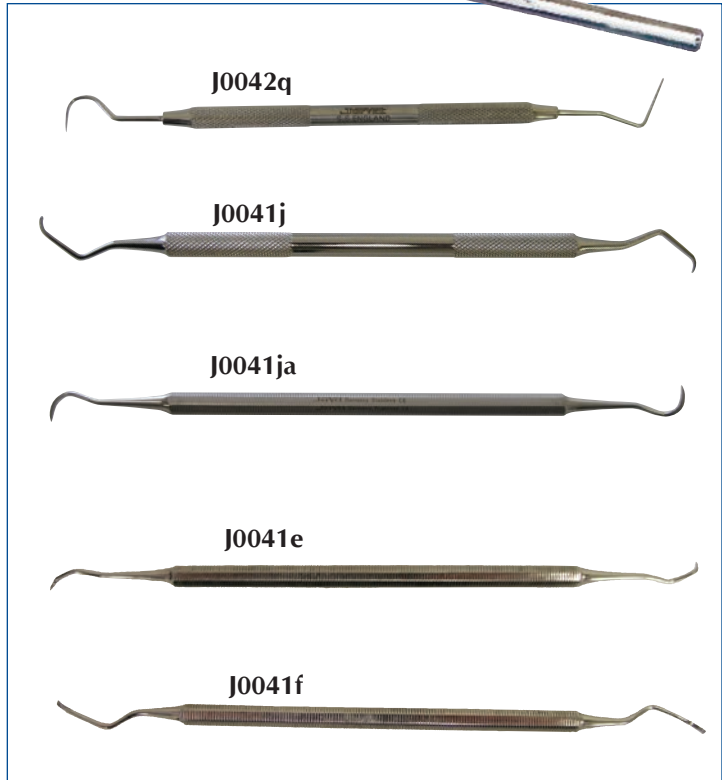

**Jacquette Scaler.** Designed to remove supragingival calculus with sharp pull strokes. The scaler tip is triangular in shape with a sharp tip.

**J0041j Jacquette Scaler.** 2. 3ss. Double end.  
**J0041ja Jacquette Scaler.** 6. 7ss. Double end.

**Curette.** Designed to remove subgingival calculus. To root plane, use short quick overlapping strokes.

**J0041e Columbia Curette.** C2L/C2R. Double end.  
**J0041f McCall's Curette.** 11. 12.

**J0041k Basic Dental Prophy Pack** is designed to provide complete instrumentation for providing proper dental prophy and exam. (autoclavable tray not included)

Kit includes six German-made instruments:

- J0041mi Dental Mirror.**
- J0041j Jacquette Scaler.** 2. 3ss.
- J0041ja Jacquette Scaler.** 6. 7ss.
- J0041e Columbia Curette.** C2L/C2R.
- J0041f McCall's Curette.** 11. 12.
- J0042q Explorer/Measuring Probe.**



J1340

**J1340 Periowise Periodontal Probe.** This probe has intense purple markings to provide optimal contrast and visibility in millimeter increments from 1–12mm.



- Easier to quickly and accurately determine the depth of the pocket
- Gentle to tissue, slightly flexible
- Rounded tip for safety and comfort
- Autoclavable and inexpensive
- 2pk

**J0041t Autoclave Tray** can hold the above instruments. Two layer tray. Rubber mat allows instruments to lay in any configuration.

- Autoclavable or cold sterilized
- Just wrap with drape
- Ethylene oxide
- 10" x 6" x 1 1/2"

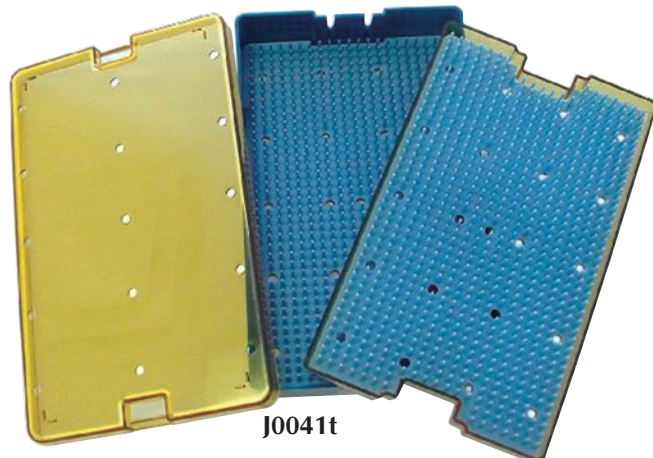

J0041t

**J0943 Dental Hand Instrument Tray.** Organizes and stores up to six hand instruments. Autoclavable up to 270°F. 3<sup>5</sup>/<sub>8</sub>" x 7<sup>3</sup>/<sub>4</sub>".

*NOTE: Do not use dry heat.*



J0943

**J0943x Steri Container.** A small sterilizable kit that holds a few special instruments. This hinged-lid container fits into ultrasonic cleaners, plus is autoclavable. 8" x 1<sup>3</sup>/<sub>4</sub>" x 1<sup>3</sup>/<sub>4</sub>".

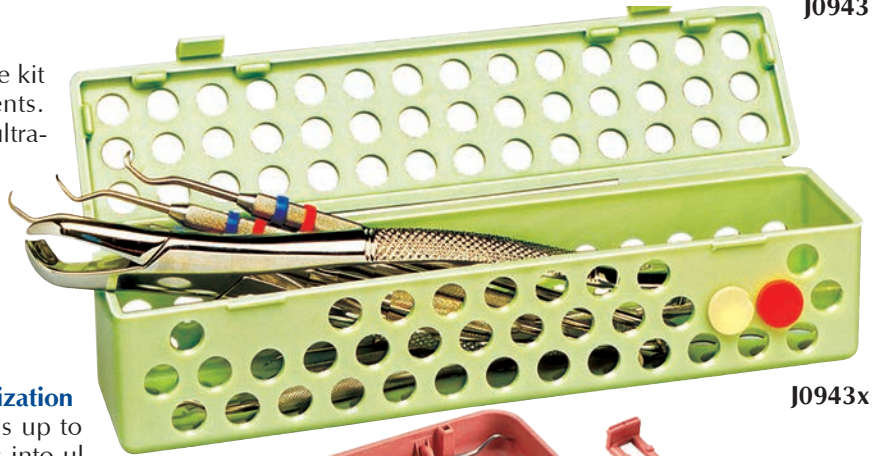

J0943x

**J0943c Compact Dental Instrument Sterilization Cassette.** This compact tray holds up to eight dental hand instruments. Fits into ultrasonic cleaners, plus is autoclavable up to 270°F. End covers snap off/on, for easy removal (left off when using a mouth mirror). A locking strap secures instruments. 4" x 7" x 5/8".

*NOTE: Suggest using CSR wraps for covering cassette in an autoclave.*



J0943c

**J0944 Dental Burr Block** holds dental burs into a convenient and easy to see block. The magnetic base holds up to 14 burs securely. Drain holes prevent rusting. Non-slip feet add stability. Autoclavable. Cover sold separately. (Burs not included.)

**J-944c Dental Burr Block Cover.** Clear. Not autoclavable, use only with cold sterilization.

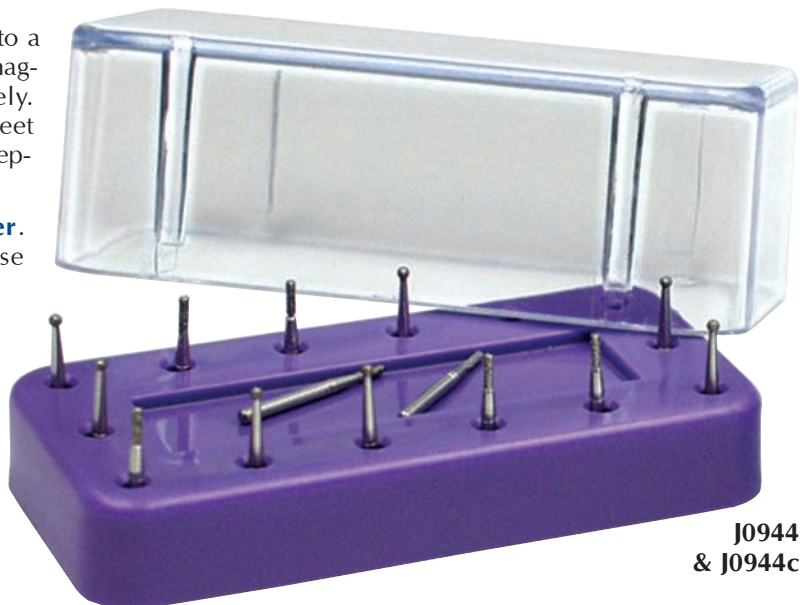

J0944 & J0944c



**Winged Dental Elevators.** Especially designed for small animal dental work, the tips have short wing blades which curve upward, further than standard elevators. This improves instrument control and following tooth conformation.

- Narrow neck improves visibility
- Short shaft for better control
- Size stamped on the stainless steel hollow 6”L handle

- J0897a** **Winged Dental Elevator,** 1.0mm.
- J0897b** **Winged Dental Elevator,** 2.0mm.
- J0897c** **Winged Dental Elevator,** 3.0mm.
- J0897d** **Winged Dental Elevator,** 4.0mm.
- J0897s** **Winged Dental Elevators.** Set of all four.
- J0897q** **Delicate Feline Dental Elevator.** Designed for small feline teeth or juvenile canine. 6”L.

**Dental Elevator with Notched “V” Tip.** Modified with a “V” cut into the end tip of this instrument, this helps the tip stay on the tooth surface and guides into the socket, preventing it from slipping and damaging the gingiva. The curved tip is designed to follow the root curves of teeth, (i.e., canine and incisor teeth). The elevator tip can be on either the outside or inside of the curved end.

- J0899a** **Feline.** Elevator tip on outside of curved tip.
- J0899b** **Feline.** Elevator tip on inside of curved tip.
- J0899c** **Canine.** Elevator tip on outside of curved tip.
- J0899d** **Canine.** Elevator tip on inside of curved tip.
- J0899s** **Dental Elevators.** Set of all 4.

**Double-End Small Dental Elevator.** This double-ended elevator has a unique veterinary design. The fine tips are both curved with an elevator groove. One end of the groove is on the inside concave side and the other end of the groove is on the outside convex side. This allows the elevator to follow the large root curves which exist on many animal teeth (i.e., deciduous canine teeth). Stainless steel knurled 7 1/4”L handle.

- J0042w** **Elevator,** Feline. 2mm.
- J0042y** **Elevator,** Canine. 4mm.

**J0899** **Periosteotome.** The periosteotome is a dual-ended instrument with flat-rounded tips and is used to gently elevate the gingival and mucosa away from a diseased pocket after an incision has been made. Tip widths are 2mm and 3mm. 6”L.

**J0899t** **Angled Tooth Fragment Forceps.** A perfect instrument for broken tooth fragments or small delicate teeth such as cat incisors. Angled. 4 3/4”L.

**Heavy Calculus/Tarter Removal Forceps.** Very heavy deposits of calculus often develop on the carnassial and other teeth. It is preferred to remove these large hard deposits with this instrument rather than using an ultrasonic scaler or an expensive orthopedic ronguer.

- J0898a** **Forceps,** Small. 4 1/2”L.
- J0898b** **Forceps,** Large. 5 1/2”L.
- J0898s** **Forceps.** Set of two.

**J1056** **Lip/cheek Retractor.** The lip or cheek retractor gently and atraumatically pulls the lips back for clear access to the teeth. The tips of the instruments are coated in plastisol to minimize discomfort. It can be adjusted by slightly bending it, 6” long and autoclavable.

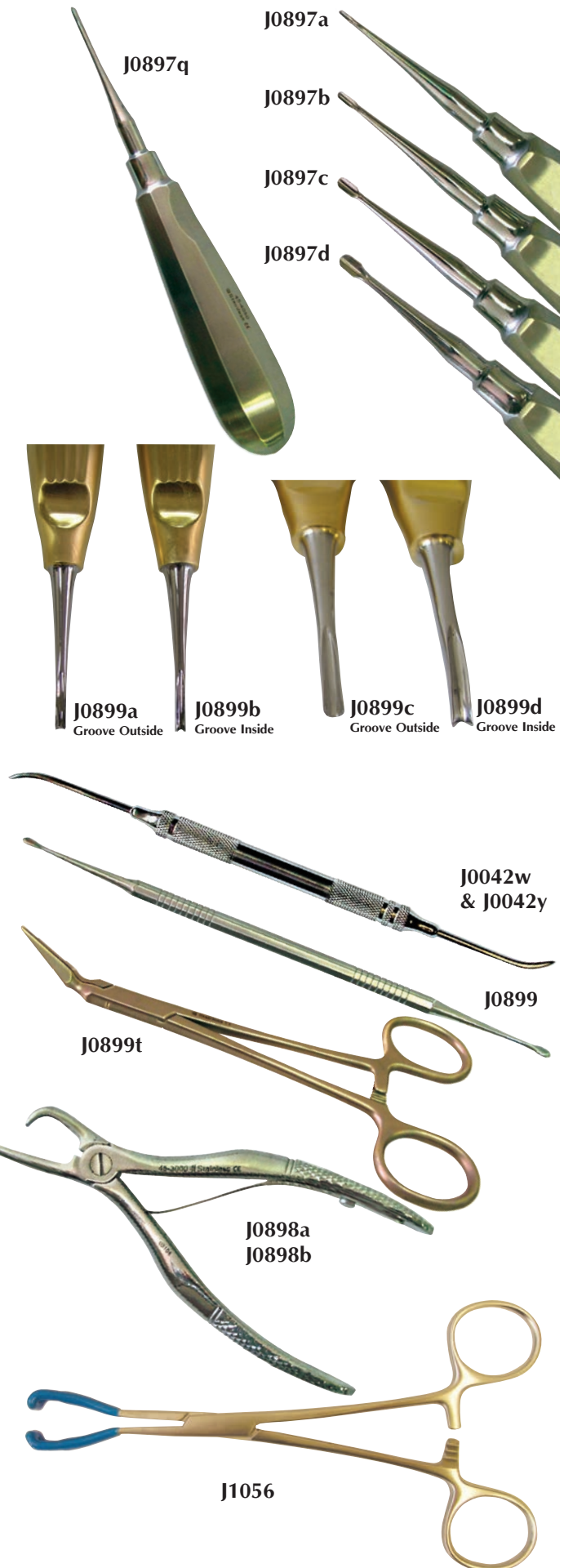



**J1150 Small Dental Extraction Kit.** This kit has all the instrumentation necessary for proper extraction. Kit consists of:

- Set of 4 different sited wing dental elevators (**J0897s**)
- Molt 2, 4, double ended periodontal elevator (**J1150b**)
- Dean scissors 7" curved handle serrated blade (**J1150a**)
- Periodontal ligament knives 3mm (**J1150d**) Very thin edge
- Periodontal ligament knives 5mm (**J1150e**)
- Dental tooth root pick (**J0042x**)
- Small curved Ronguer (**J1150c**)
- Includes storage case (not pictured)

**Periodontal Dental Elevators:** these elevators have a very thin edge and ergonomic bend. They are extremely useful when extracting larger teeth in cutting through the periodontal ligament.

**Periodontal Ligament Knives:** these are periodontal ligament knives to aid in atraumatic extractions. The tip is thin and sharp to minimize trauma. They are not dental elevators, and are sometimes referred to as luxators®. JorVet periodontal ligament knives are not a product of Directa AB® of Sweden.

**Winged Elevator Stubby Handle**

- Smaller, rounder handle
- Allows more leverage for smaller hands

- J0897as** Winged elevator 1mm
- J0897bs** Winged elevator 2mm
- J0897cs** Winged elevator 3mm
- J0897ds** Winged elevator 4mm
- J0897ss** Set of all four sizes in Stubby handle

**J1150s** Dental extraction set with Stubby handled winged elevators. Same as **J-1150**, except with the Stubby handles.

**J1150d** Periodontal Ligament Knives. 3mm curved or offset head elevators are designed to cut through the periodontal ligament. They have a very thin edge.

**J1150e** Periodontal Ligament Knives. 5mm curved or offset head

**J1150b** Molt 2, 4 double ended periodontal elevator

**J1150a** Dean scissors. 7" curved handles serrated blade



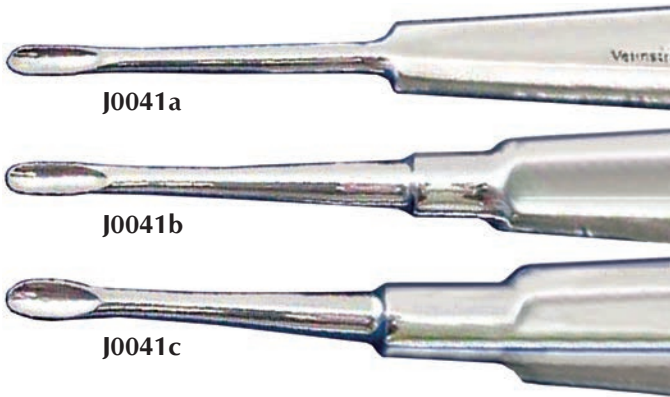

J0041a

J0041b

J0041c



J0043s



J0043m



J0042t



J0042r



J0042x

**Canine Dental Elevator.**

**J0041a Dental Elevator.** Small. Cats and fractured tooth tips. 2mm head. 6".

**J0041b Dental Elevator.** Medium. Mid-sized dogs. 3mm head. 6".

**J0041c Dental Elevator.** Large. Large dogs and K-9 teeth. 4mm head. 6".

**Economy Models.**

**J0043s Dental Elevator.** Small. 2mm. 5 1/4".

**J0043m Dental Elevator.** Medium. 3mm. 5 1/4".

**J0042r Smaller Feline Dental Extractor** with spring loaded handles. Stainless steel. 4 1/2".

**J0042t Small K-9 and Feline Dental Extractor.** This extractor is smaller and lighter weight with special jaws that close together along their whole interface. Especially designed for small dog and feline teeth or tooth fragments. Also useful in removing tartar/calculus. Made in England. 6".

**J0042x Dental Tooth Root Pick.** Heid Brink tooth ejector. Sometimes during extraction, tooth fragments can break off and remain in the socket. This instrument has a thin delicate tip that helps loosen and remove those remaining fragments.

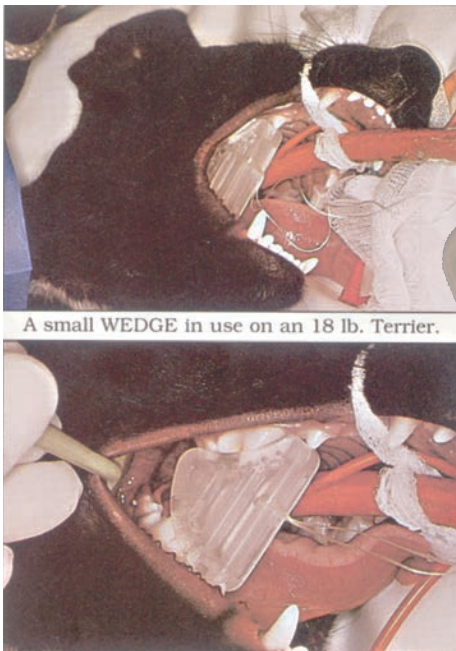

A small WEDGE in use on an 18 lb. Terrier.



**The Wedge Veterinary Mouth Prop.** The use of a mouth gag or speculum is a common procedure in small animal medicine. Maintaining an open mouth is a requirement for many dental cases and for proper examination of the upper airways.

The wedge is a clear plastic mouth prop that features:

- Anatomic design for proper, secure placement between premolars and molars
- Radiolucent for unobstructed radiographs
- Autoclavable
- A hole is provided to attach a suture for emergency removal
- Can be used if canine teeth are absent
- Soft and pliable for patient comfort.
- Suggested uses: intubation, oral surgery, dental procedure, oral exam, radiographic exam

**J0051q Mouth Prop.** Small. Cats and small dogs, <20 lbs.

**J0051r Mouth Prop.** Large. Medium and large dogs, >20lbs.

**Comfort Handle Elevators.** The Comfort pattern elevators takes a radical new look at elevator handles. A range of new designs was tested by both nurses and veterinary surgeons to find the most comfortable design. the most popular pattern fits into the palm of the hand allowing the fore finger to be positioned along the shaft for added control.

Supplied in fully autoclavable color coded Teflon in 1, 2, 3, and 4mm widths. Available individually or as a set of 4.

- J1230**     **Comfort Elevator.** 1.0mm. White
- J1230A**     **Comfort Elevator.** 2.0mm. Green
- J1230B**     **Comfort Elevator.** 3.0mm. Blue
- J1230C**     **Comfort Elevator.** 4.0mm. Black
- J1230S**     **Comfort Elevators Set of 4 including free stainless steel case.**

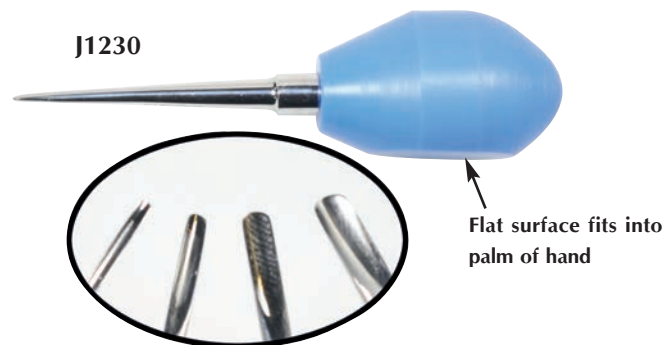

**Veterinary Comfort Winged Elevators.** They have short winged blades with lateral edges which curve upwards further than traditional elevators, improving conformation to the root structure as well as instrument control. The narrow neck enhances visibility of the root and the shorter shaft improves handling and control, especially if the operator's hands are not large. The design incorporates the best parts of an elevator and a periodontal knife. Handles are very comfortable in use. Flattened surface prevents rolling off the tables. Available as a boxed set.

- J1231**     **Comfort Winged Elevator.** 1.0mm. White
- J1231A**     **Comfort Winged Elevator.** 2.0mm. Green
- J1231B**     **Comfort Winged Elevator.** 3.0mm. Blue
- J1231C**     **Comfort Winged Elevator.** 4.0mm. Black
- J1231S**     **Comfort Winged Elevator Set with Stainless Steel Case.**

J1231





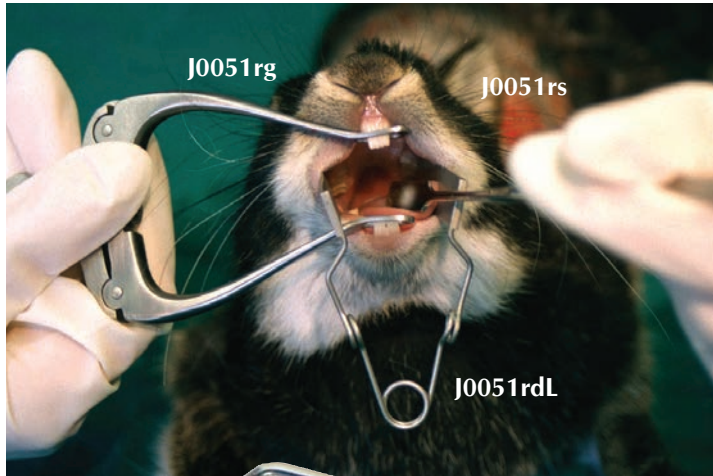

**Dental Equipment for Rabbits and Rodents.** The popularity of “pocket pets” has led to the development of specialized equipment to meet their veterinary care requirements. JorVet is the first to introduce specialized equipment for proper rodent and rabbit dental health.

Without gags and dilators examination and treatment of rabbit molars is virtually impossible.

**Cheek Dilator.** The cheek dilator allows visualization of molars and protects cheeks from instruments.

**J0051rds Cheek Dilator.** Small. Also useful as a gag for guinea pigs and chinchillas.

**J0051rdL Cheek Dilator.** Large.

**J0051rdLx Cheek Dilator.** Large with long reach.



**J0051rg Rodent Mouth Gag.** Examination of the rabbit mouth is virtually impossible without a gag of this type.

**J0051rgs Light weight Rodent Mouth Gag.** Smaller with less bulk than standard rodent gag. Knurled knob adjusts opening.

**J0051rs Spatula.** Used to deflect tongue and cheeks to enable best possible view of problems.

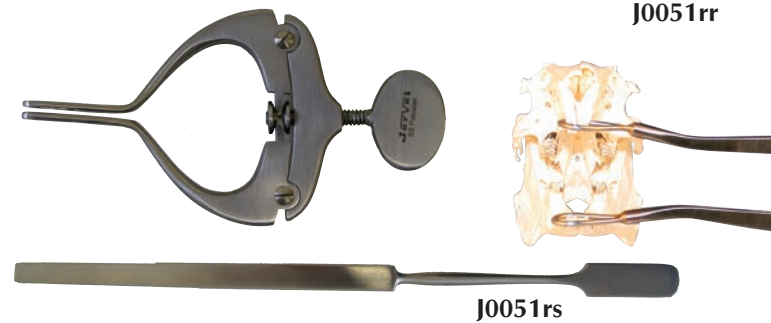

**J0051rr Molar Rasp (rabbits).** Unsuitable for debulking but good for removal of small spurs.

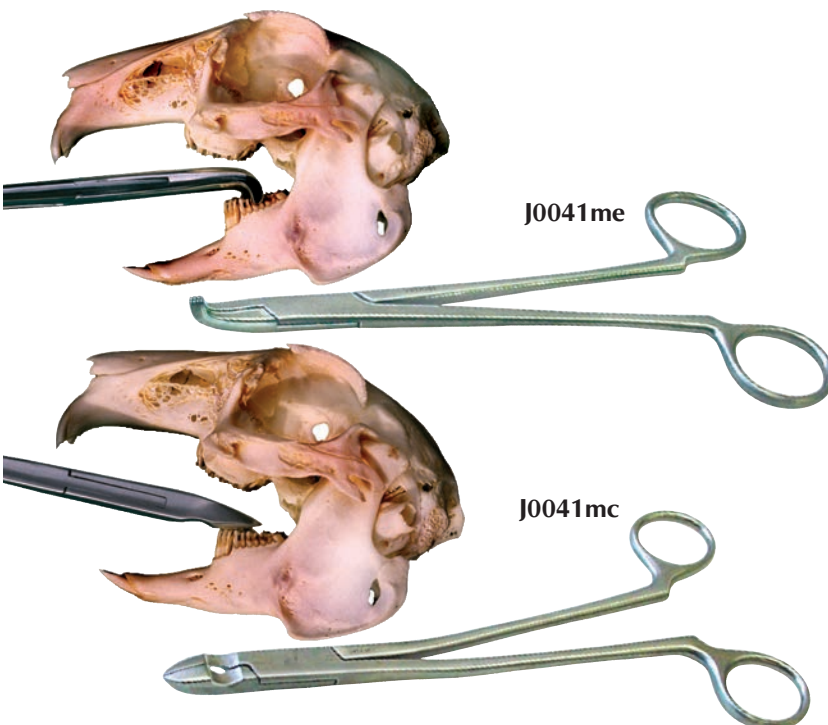

**J0041me Molar Extraction Forceps.** Most abscesses around the rabbit head have their origin in molar tooth roots. Designed to grip without crushing.

With very little space inside a rabbit mouth, these forceps are very slim and angled to fit in the mouth without totally obscuring the teeth.

**J0041mc Molar Cutters.** Use to debulk or for trimming spurs and hooks. Unique shape enables the surgeon to see what is being cut.



J0041cr

**J0041cr Crossley Rabbit Incisor Luxator.** Incisor malocclusion with resulting over growth is a common and serious problem in rabbits. Frequent clipping is required with the risk of splitting the incisors. Extraction is the only permanent solution but the roots of the incisors are large relative to the jaw. The Crossley incisor luxator was designed especially for this procedure. The instrument matches the shape of the rabbit incisor. It is double ended for various size incisors. Complete with instructions for use.



J0041mr

**J0041mr Crossley Molar Luxator.** Designed to facilitate extraction of molars with a minimum of damage to the alveolus and surrounding soft tissue. One cutting blade is for insertion down buccal or lingual surface. The other end of the instrument is set at right angles to penetrate between molars.

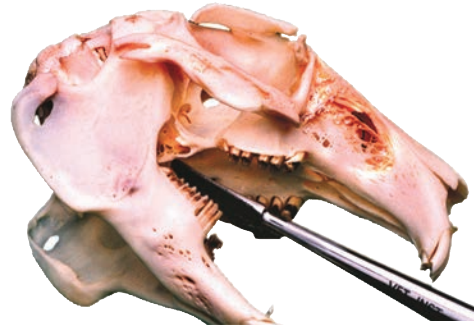

**Diamond Molar Rasps.** Unsuitable for debulking, but good for tidying. The diamond rasp's surface is concave to fit over the molars without slipping off. Diamond grit is the ideal material to remove tooth spurs without damaging the delicate root structure

**J0041rf Molar Rasp.** Fine diamond.

**J0041gf Molar Rasp.** Fine. For guinea pigs & chinchillas.

**J0041r Molar Rasp.** For rabbits.

J0041rf, J0041gf, J0041r



J0041rk



J00452d7

**J00452d7 Diamond Disc.** For trimming incisors (shown with straight handpiece from dental polisher).

**J0041rk Rabbit Burr Kit.** Block stainless steel kit. Consists of 3 pairs of burs (total 6 different burs). Friction fit.

**J0041ss Diamond Disc Safety Shield.** Safety Shield.

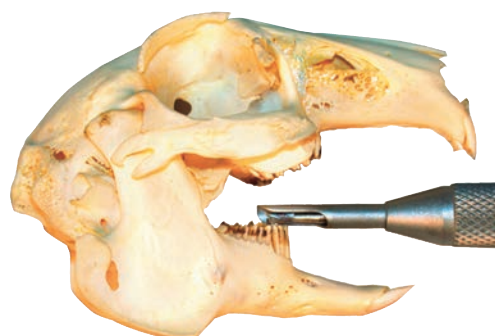

J0041st & J0041cc



J0041ss

**J0041st Soft Tissue Protector.** Fits polishing head of a dental unit.

**J0041cc Extra-Long Cross Cut Burr.** For use with above soft tissue protector.





**J0051rk Rabbit/Rodent Dental Starter Kit.** A convenient cost saving kit that gets the practitioner started with the basics for this expanding field.

Kit Includes:

- J0051rg Mouth Gag.**
- J0051rdL Cheek Dilators. Large.**
- J0051rds Cheek Dilators. Small.**
- J0041mc Rodent Dental Molar Cutters.**
- J0051rs Rodent Mouth Spatula.**
- J0051rr Molar Rasp for "Floating" Teeth.**
- J0399a Instrument Storage Tray. 10<sup>1</sup>/<sub>2</sub>" (L) x 6<sup>3</sup>/<sub>4</sub>" (W) x 2" (D).**



**J0931 Rabbit/Rodent Dental Head Support.** If you are serious about rabbit/rodent dentistry, this is the piece of equipment you need. This special device is designed for hands-free dental work on smaller pocket pets and rabbits. The support tilts to various angles. Two metal posts hold a mouth speculum via thin metal adjustable bars. This also serves to hold the animal's head steady and the mouth open to exactly the desired size. Fiber composite base. 12cm W x 19–27cm H x 23cm D.

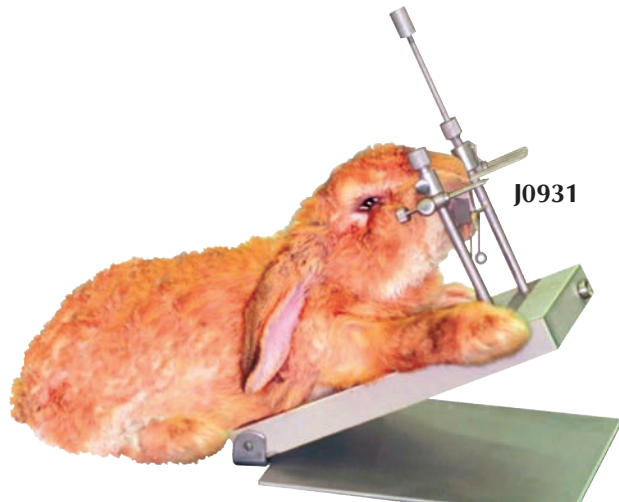

**J0931a LED Light** for use with **J0931 Head Support.** This light positions onto the threaded portion of the head support. It has a flexible goose neck for easy adjustment. Battery operated.



**J0453 Pro Polisher/Micromotor.**

- 300–30,000 rpm
- 1:1 straight handpiece
- Metal prophy angle, forward & reverse functions
- Starter kit includes prophy paste and polishing cups
- Extra disposable prophy angles
- Operates from either foot switch or push-button control
- May be used with optional diamond cutting discs, contra angle, and diamond burs
- 12-month warranty



**J0453**



**JorVet Premier Ultrasonic Scaler/Polisher.** This dental unit is new to JorVet, but not to the veterinary world. SouthEast Instruments has provided the best of ultrasonic dental units to the veterinary profession for over 25 years. Made in America. This dental unit is a clinic workhorse that is able to withstand the rigors of daily use over time.

- Incredible 6-year warranty on circuit boards, 2 years on all other internal components
- 2-year warranty on scaling handpiece (detachable for easy replacement)
- 6-month warranty on micromotor, prophylaxis heads, 90-day warranty on ultrasonic inserts
- Complimentary loaner program
- Powerful 25k magnetorestrictive frequency inserts
- Will work for periodontal scaling on lower setting
- 25% power increase setting for use on heavy tough calculus
- Foot pedal operation
- Included 2 inserts: one universal and one spatula tip. Optional periodontal insert available
- Micromotor Swiss made: no lubrication needed, speeds of 450rpm to 12,000rpm, wide enough range for drilling or polishing
- Accepts metal prophylaxis head "U" style included (J1180d3)
- Other cutting and drilling accessories are optional
- Male quick release water line end
- Includes prophylaxis cups and paste

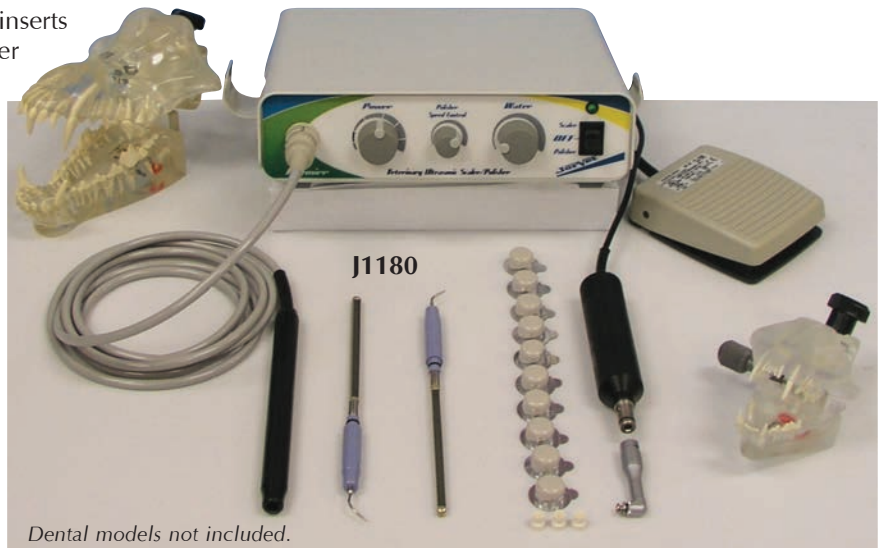

Dental models not included.

- J1180 Complete unit scaler/polisher.** 110 volt.
- J1180a Complete unit scaler/polisher.** 220 volt.

Optional Accessories

- J0452d4 Portable water tank**
- J1180d5 Contra angle "U" style latch type**
- J0452d1p Periodontal ultrasonic insert**

**JorVet Premier Ultrasonic Scaler.** This dental unit is new to JorVet, but not to the veterinary world. SouthEast Instruments has provided the best of ultrasonic dental units to the veterinary profession for over 25 years. Made in America. This dental unit is a clinic workhorse that is able to withstand the rigors of daily use over time.

- Incredible 6-year warranty on circuit boards, 2 years on all other internal components
- 2-year warranty on scaling handpiece (detachable for easy replacement)
- 90-day warranty on ultrasonic inserts
- Complimentary loaner program
- Powerful 25k magnetorestrictive frequency inserts
- 25% power increase setting for use on heavy tough calculus
- Foot pedal operation
- Included 2 inserts: one universal and one spatula tip. Optional periodontal insert available
- Male quick release water line

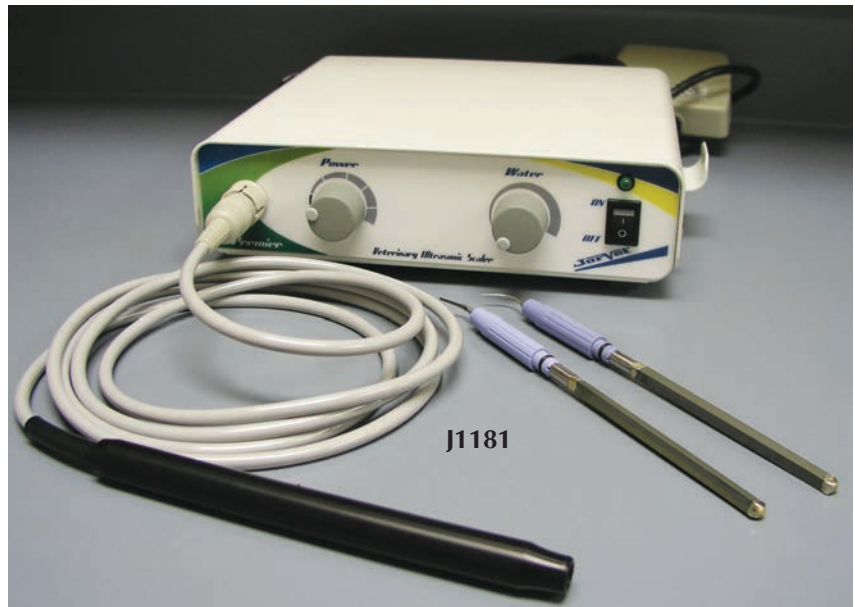

- J1181 Complete Scaler.** 110 volt.
- J1181a Complete Scaler.** 220 volt.

Optional Accessories

- J0452d4 Portable water tank**
- J0452d1p Periodontal ultrasonic insert**

JorVet offers two models of scaler-polisher combo units: Magnostriuctive and Piezo.

J0841q



**J0841q Ultrasonic Scaler/Polisher.** This is our new dental combo unit with a sleek design and affordable price! It is the workhorse your hospital needs!!

- Contemporary design with a small footprint
- Operation frequency 25kHz
- Includes in-line water filter, 2 inserts (1 spatula, 1 universal), micro-motor, polisher hand-piece, prophy angle, prophy cups and paste starter kit
- Comes with quick release attachment for water tank set-up (optional water tank **J0452d4**)
- Large, easy to read LED power display
- Micromotor variable speed 2,000-30,000 rpm with forward/reverse
- Foot pedal operation
- Optional drilling and sectioning attachments available
- 6-year limited warranty (90 days on inserts and prophy angle, 1 year on the handpiece)
- Dimensions: 6"L x 8"W x 3.5"H
- Weight: 6.5 lbs.

**J0841x Piezo Electric Scaler/Polisher Combo Unit.** We now offer a combo unit with the very popular Piezo hand piece with a sleek design at an affordable price!

- Contemporary design with a small footprint
- Operation frequency 29kHz
- Includes in-line water filter, 3 scaler tips (2 universal, 1 spatula), micro-motor and polisher handpiece, prophy angle, prophy cups and paste starter kit
- Comes with quick release attachment for water tank set-up (optional water tank **J0452d4**)
- Micromotor variable speed 2,000-30,000 rpm with forward/reverse
- Large, easy to read LED power display
- Foot pedal operation
- Optional drilling and sectioning attachments available
- 6-year limited warranty (90 days on tips and prophy angle, 2 years on handpiece)
- Dimensions: 6"L x 8"W x 3.5"H
- Weight: 6.5 lbs.

J0841x

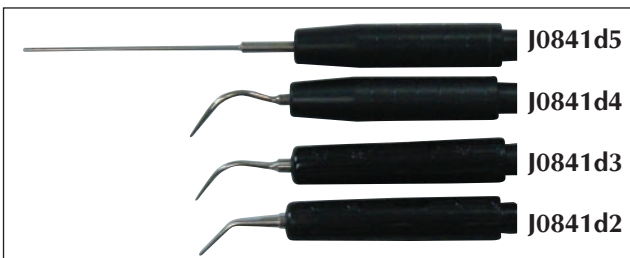

These inserts are for the **J0841 Dental Unit only**. They will not work with J0841q or J0841x.

- J0841d2 Ultrasonic Dental Insert.** Spatula tip.
- J0841d3 Ultrasonic Dental Insert.** Universal tip.
- J0841d4 Ultrasonic Dental Insert.** Periodontal tip.
- J0841d5 Ultrasonic Dental Insert.** Feline urethral tip.

*NOTE: These inserts are NOT interchangeable with any other dental units.*

**J0842x** **Piezoelectric ultrasonic scalers** differ from the conventional ultrasonic scalers. The piezo handpiece generates its ultrasonic waves via four ceramic plates subjected to high frequency alternation current. The electric mechanical efficiency of this system is much greater than that of traditional magnostriuctive systems. There is very little heat released and it is possible to work with very little water spray.

- Sleek contemporary design
- Operation frequency 29KHZ
- 4 tips included, 2 universal, 1 spatula and 1 periodontal
- Unique LED display indicates the power level that will best perform endo, periodontal work, or scaling.
- Foot pedal operation
- 6 year limited warranty (90 days on tips, 2 years on handpiece).
- Dimensions: 6<sup>1</sup>/<sub>2</sub>"W x 9"L x 3<sup>1</sup>/<sub>2</sub>"H
- Weight: 3 lbs. 14 oz.

**Accessories and Replacement Parts**

- J0842xd1 - Piezo universal tip**
- J0842xd2 - Piezo spatula tip**
- J0842xd3 - Piezo periodontal tip**
- J0842xd4 - Piezo handpiece**
- J0842xd5 - Piezo wrench**



**J0842q** **JorVet Ultrasonic Scaler**

- Our new magnostriuctive ultrasonic scaler has a sleek design with a small footprint size.
- Operates on 25KHZ
- Includes 2 inserts, one universal and one spatula tip.
- Unique LED display, same as J-842x
- Foot pedal operation
- 6 year limited warranty (90 days on tips)
- Dimensions: 6<sup>1</sup>/<sub>2</sub>"W x 9"L x 3<sup>1</sup>/<sub>2</sub>"H
- Weight: 3 lbs 14 oz.

**Accessories**

- J0452d1 - universal insert**
- J0452d2 - spatula insert**
- J0452d1p - periodontal insert**



**J0452d4**

**J0452d4** **Portable Water Tank.** 1-gallon capacity.







- J0452d1** Dental “Cavitron” insert with narrow tip.
- J0452d2** Dental “Cavitron” insert with wide spatula tip.
- J0452d3** Metal Prophy Angle slip fit.
- J0452d5** Prophy Polishing Paste. Grey with flouride. 100/pkg. Mint flavor.
- J0452d5b** Bulk Prophy Paste. Large container with the most economical value. Fruit flavor. (not pictured)
- J0452d6** Snap-On Rubber Cups. 100/pkg.
- J0452d6s** Screw-On Prophy Cups. 100/pkg. (not pictured)
- J0452d7** Diamond Cutting Disc. Fits directly into hand-piece.
- J0452d8m** Diamond Dental Burrs. Seven. Use with contra angle. Includes handy display tray. (not pictured)
- J0452d9** Contra Angle. Friction grip.

- J0452d10** Straight hand piece for “E” style micromotors.
- J0452d12** Disposable Prophy Angles. 12/pkg.
- J0452d15** Male quick disconnect for waterline.
- J0452d17** Female quick disconnect for waterline.
- J0452d19** Faucet connector for dental unit. Opposite end is female quick connect.



- J0841La** Handpiece Lubricant. 8 oz. (not pictured)
- J0969** Dental Plaque Disclosing Solution. This solution will stain a tooth surface bright cherry red if plaque is present. Some Suggested uses:
  - A client education aid to show extent of patient plaque
  - Evaluation of home tooth brushing effectiveness
  - Follow-up to dental prophy to make sure procedure was complete
 Simple to use: swab an area with moistened cotton tip applicator. 2 oz dispensing bottle with screw cap.

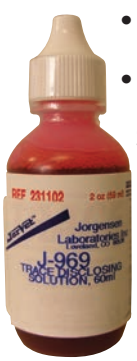

J0969

- J1341** 2pro™ Disposable prophy angle features a patented dual-action cup and tip design to guarantee total access to all tooth surfaces. 12 to a pack.
  - After initial polishing, remove the cup and clear inaccessible areas with 2pro’s unique gentle tip
  - Runs smoothly and quietly
  - Patented gearless design ensures near zero freeze ups and less heat build-up
  - Easier access to lingual areas
  - Latex free



**GET TOTAL ACCESS!**  
Clean and polish all tooth surfaces with its unique cup and tip design.

All burrs and disks are of quality German manufacture Carbide. Burrs are designed to fit latch-style or friction fit contra angle.

**Premier Dental Accessories.** For use with **J1180** Dental Unit. Latch style burrs have a retention groove cut in the proximal end.



**J1180d5** Contra Angle Latch Style

**J1180bp** Burr Set - 5 Pack Latch Style.

- J1180d12** Chamfer
- J1180d8** Round .023
- J1180d11** Fissure
- J1180d9** Flame
- J1180d14** Inv Cone .018

**J1180bpL** Burr and Disk Set - 10 Pack Latch Style

- J1180d13** Disk
- J1180d12** Chamfer
- J1180d11** Fissure
- J1180d10** Egg Shape
- J1180d9** Flame tip
- J1180d7** Round .027
- J1180d8** Round .023
- J1180d6** Round .021
- J1180d14** Inv Cone .018
- J1180d4** Inv Cone .016

**J1180d13** Double Sided Cutting Disk Latch Style. Cutting or sectioning larger teeth.Sold individually or in kit.

**J1180d12** Modified Parallel Chamfer. Used when flat or parallel surfaces are needed. 5-pack or kit.

**J1180d11** Carbide Round End Tapered Fissure. Used for cutting or shaping hard to reach places. 5-pack or kit.

**J1180d10** Carbide Egg Shaped Burr. Used for rounding or shaping. 5-pack or kit.

**J1180d9** Carbide Flame Tip Burr. Useful in trimming near gum line. 5-pack or kit.

**J1180d8** Carbide Round Burr .023. Used for shaping or enlarging. 5-pack or kit.

**J1180d7** Carbide Round Burr .027. Used for shaping or enlarging. 5-pack or kit.

**J1180d6** Carbide Round Burr .021. Used for shaping or enlarging. 5-pack or kit.

**J1180d14** Carbide Inverted Cone .018. Used for shaping or trimming. 5-pack or kit.

**J1180d4** Carbide Inverted Cone .016. Used for shaping or trimming. 5-pack or kit.



**J1180d13**



**J1180d11**



**J1180d10**



**J1180d9**



**J1180d8**



**J1180d7**



**J1180d6**



**J1180d14**



**J1180d4**

**Friction-Grip Dental Accessories.** For use with **J841q, J841x** and other dental units.



**J0452d9** Contra Angle Friction-grip.

**J0452kbp5** Burr Set - 5 Count Friction-grip.

- J0452k1** Parallel Chamfer
- J0452k3** Fissure .016
- J0452k5** Flame .018
- J0452k6** Inverted Cone .018
- J0452k8** Round Burr .023

**J0452kbp10** Burr and Disk Set - 10 Count Friction-grip

- J0452k10** Cutting Disk
- J0452k1** Parallel Chamfer
- J0452k2** Egg-shaped Burr
- J0452k4** Fissure, Tapered Sx L
- J0452k3** Fissure .016
- J0452k5** Flame .018
- J0452k6** Inverted Cone .016
- J0452k7** Inverted Cone .018
- J0452k8** Round Burr .023
- J0452k9** Round Burr Sx L .023

**J0452k10** Double Sided Cutting Disk FG Style. Cutting or sectioning large teeth.Sold individually or in kit. 18mm.

**J0452k1** Modified Parallel Chamfer Modified FG. Used when flat or parallel surfaces are needed. 5-pack or kit.

**J0452k2** Carbide Egg-shaped Burr. Used for rounding or shaping. 5-pack or kit.

**J0452k3** Carbide Fissure, Tapered Round End. Used for cutting or shaping hard to reach places. 5-pack or kit.

**J0452k4** Carbide Fissure SX L, Tapered. Surgical length. Used for cutting or shaping hard to reach places. 5-pack or kit.

**J0452k5** Carbide Flame Tip Burr. Useful for trimming near gum line. 5-pack or kit.

**J0452k6** Carbide Inverted Cone .016. Used for shaping or trimming. 5-pack or kit.

**J0452k7** Carbide Inverted Cone .018. Used for shaping or trimming. 5-pack or kit.

**J0452k8** Carbide Round Burr .023. Used for shaping or enlarging. 5-pack or kit.

**J0452k9** Carbide Round Burr Sx L .023. Surgical Length. Used for shaping or enlarging. 5-pack or kit.



**J0452k10**



**J-452k1**



**J0452k2**



**J0452k3**



**J0452k4**



**J0452k5**



**J0452k6**



**J0452k7**



**J0452k8**



**J0452k9**

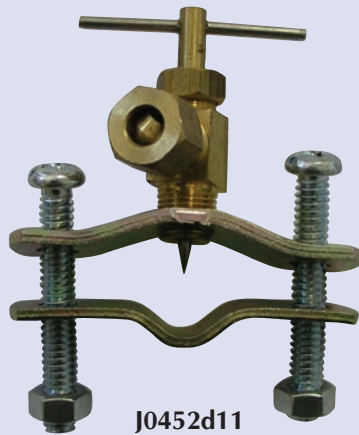

J0452d11

**J0452d11 Saddle Valve Water Hook-Up.** Allows dental water line to splice into pressurized water line, i.e., under a sink.

**J0452d14 Saddle Valve with Quick Release.** (not pictured)



J0452d13m

**J0452d13m In-Line Water Filter.** Inline water filter with internal filter disk. Many water sources have particulate debris that can clog your dental unit. Screen can be cleaned under tap water monthly.

**J0452d13rf Spare Filter Screens** for old style filter. (not pictured). Do not fit J-452d13m.

*The use of protective eyewear during dental procedures is not only a good safety and hygiene practice, it is mandated by OSHA guidelines.*

**Face and Eye Shields.** Routine veterinary dental work using ultrasonic scalers/polishers and high speed handpieces creates aerosol and spatter. The aerosol consists of saliva, water, and microbes—plus blood and tooth debris can sometimes be present. Every veterinarian and technician knows that dog and cat bite wounds are readily infected with the plethora of serious bacteria living in the animal's oral cavity.



Protective eyewear not only protects the eyes, nose, and mouth (with a face shield) from contact with infectious agents, but also against any physical damage from propelled objects including tooth or calculus fragments becoming dislodged.

The JorVet eye or face shields provide comfortable fit with superb protection at a reasonable cost.

**Eye Shield**

- Consists of reusable, lightweight frames, which thin, clear lenses snap onto.
- Removable protective film protects lenses before use.
- One size fits all.
- Frames come in an assortment of colors

**J0518 Eye shield starter kit with 10 frames and 25 shields**

**J0518s Eye shields only refill kit**

**Face Shield**

- Covers the entire face
- Consists of reusable, lightweight frames, which thin, clear lenses snap onto.
- One size fits all with an adjustable strap.
- Easily worn over glasses and masks.

**J0519 Face shield starter kit with 10 frames and 10 shields**

**J0519s Face shields only kit, 10pk.**



J0518



J0519



**PROTECT YOURSELF**

**Protective Eyewear Special for Women.** This range of protective eyewear is especially designed for women both in sizing and style.

- Unique design fits more securely and comfortably on smaller faces.
- Full wrap around provides superior splash protection
- Glare reducing models are ideal for bright light environments
- Blue also increases contrast
- Stylish design for attractive appearance

**J1187 clear**

**J1187a blue**

**J1187b mirror**

**12-pack of Colorful Economy Safety Glasses.**

- Pack includes 2 of each color: orange, black, green, purple, red, and blue
- 100% clear poly carbonate lenses are coated for scratch resistance
- Wrap around style
- Inexpensive

**J1188 12pk economy safety glasses**

**Comfortable Protection over Existing Eyewear.**

- Contemporary design fits over newer styles of corrective eyewear
- Adjustable lens pitch and temple length for comfortable fit

**J1189 Over-glasses protective eyewear.**

**Onix Protective Eyewear.**

- Higher quality protective eyewear
- Adjustable temple, lens angle, and nose pad provides custom comfort for all users and unique tasks
- Polycarbonate design is lightweight for all day wear

**J1189a clear lens with black frame**

**J1189b clear lens with pink frame**

**Reading Safety Glasses.**

- Integrating the need for safety glasses together with reading glasses
- Adjustable arm length
- Clear lenses with black frame

**J1189c 1.5diopter**

**J1189d 2.0diopter**

**J1189e 2.5diopter**



Clear



**Blue**  
Ideal for bright-light environments, reduces glare and increases contrast



**Mirror**  
Great for bright-light environments and reduced glare

**J1187**



**J1188**

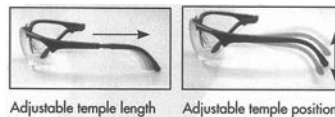

**J1189**



**J1189a**



**J1189b**



**J1189c, d, e**

**Ophthalmic Diagnostic Test Strips.** JorVet introduces a new range of commonly used ophthalmic test strips at an affordable rate.

**J1192 Dri-I Schirmer Test Strip.** The standard for measuring tear production for possible diagnosis of Keratoconjunctivitis Sicca (dry eye). Graduated absorbent paper with mm graduations is inserted at the lateral canthus between the eye and eyelid and absorbs tear film.

- Individually packaged in sterile chevron pouch
- No anesthesia necessary
- 100 strips per box
- Compare against chart on back of box. Measurements after one minute should be:

Most dogs	17–22mm
Questionable	5–8mm
Definite	<5mm
Satisfactory	>9mm



**J1191 I-Glo Fluorescein Dye Strips.** A great tool for detection of corneal injuries or defects. Every eye that has signs of pain should be checked with fluorescein. Tear film will wash dye across cornea. The area of the cornea injury will glow fluorescent green.

- Each strip has orange-colored fluorescein dye in a sterile single chevron package.
- Sterile, single strips
- 1.0mg fluorescein dye per strip
- 100 strips per box





J0045

- J0045 Gowlland's Mayfield Veterinary Diagnostic Set.**
- Otoscope Head.
  - 3 Veterinary Long Specula. 80mm x 6mm, 80mm x 4mm, 58mm x 5mm.
  - 1 Spare Bulb.
  - 1 Ophthalmoscope Head.
  - Case.
  - Medium Battery Handle. Uses 2 "C" batteries. (not included)



J0068

- J0068 Eyelid Retractor.** Stainless steel. 4".



J0068d

- J0068d Desmarres Chalazion Forceps.** Helps to immobilize the eyelid for surgery. Also useful in constricting vessels to reduce hemorrhaging during eyelid surgery.

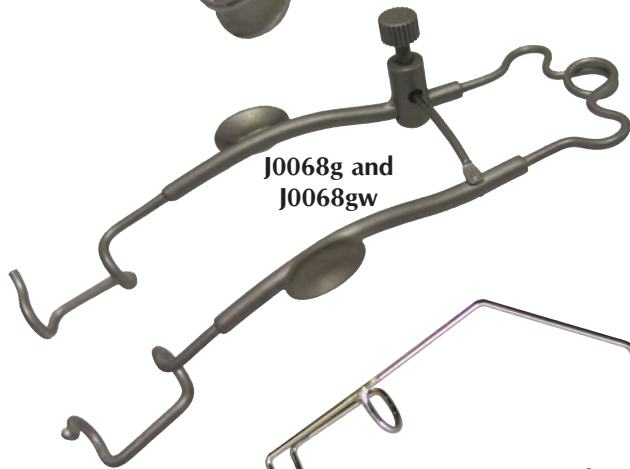

J0068g and J0068gw

- J0068g Graefe's Eye Speculum** for small animals.  
**J0068gw Eye Speculum.** German-made.



J0068b

- J0068b Barruquer Eyelid Speculum.** 1<sup>3</sup>/<sub>4</sub>" (4.4cm). 15mmW blade.



J0075iwc

- J0075iws Iris Scissors.** Straight. 4<sup>1</sup>/<sub>2</sub>".  
**J0075iwc Iris Scissors.** Curved. 4<sup>1</sup>/<sub>2</sub>".



J0314a

- J0314a White Slit Light.** Designed with a high intensity white slit for cataract evaluation, checking the anterior chamber or for corneal edema. AA batteries included.



J0314b

- J0314b Fluoro-Dot.** This light has a special cobalt blue filter and is designed to be used with fluorsein dye. It is excellent for the diagnosis of corneal abrasions or ulcers. Many small abrasions can easily be missed but the Fluoro-Dot light makes them stand out.



**Every person having an annual eye exam is checked for glaucoma.  
Why should our veterinary patients be different?**

Glaucoma is the leading cause of blindness in animals. Early detection is the only way of controlling it. The reasons to check for it:

**Every Eye Exam**  
All "red" eye cases  
Geriatric exams

**A Follow Up To**  
Eye trauma  
Head trauma



## TonoVet®

The use of tonometry to measure Intra Ocular Pressure (IOP) is the only real tool for the screening of glaucoma in veterinary patients. IOP measurements are accomplished by using instruments called tonometers which measure IOP from the outside surface of the cornea.

Traditional tonometers like the Tonopen Vet measure by the "applanation" method. The instrument is repeatedly pushed against the cornea manually. The amount of force necessary to flatten the cornea is calibrated and an electronic read out is made in mm of Hg.

The TonoVet utilizes a newer technology called "rebound" tonometry. The portable hand held unit is about 1/4" away from the cornea. At the push of a button, a tiny probe painlessly and rapidly reaches out and touches the cornea. Six rapid measurements are taken within seconds. Most of the time the animal will not even react and certainly no local anesthesia is required. An audible beep tells of a successful result, which is displayed digitally.

The TonoVet has been used on all veterinary patients including equine. The TonoVet is self-calibrating with its own software.



### Why the TonoVet?

- It is easy to use and fully automated.
- Faster results
- More comfortable for the patient, no topical anesthetic
- Higher accuracy at higher and lower IOP
- Longer warranty—2 years
- In clinic training available
- Instructional DVD included
- Held upright in a natural, ergonomic position like an ophthalmoscope versus horizontally like a flashlight.

### Specifications

Weight: 155g (5oz) without batteries; 250g (8oz) with batteries  
Power Supply: 4 x AA batteries (approx. 1,000 measurements per battery set)

Measurement Range: 1-99 mm Hg

Size: 13-32mm W x 45-80mm D x 230mm L

Padded Storage Case Provided

Two year limited warranty



- J1000 Complete unit with 100 extra probes and storage case**  
**J1000d1 Extra probes (100 per package):**  
**J1000v TonoVet informational CD**

Visit [www.JorVet.com](http://www.JorVet.com) for video on use plus scientific articles

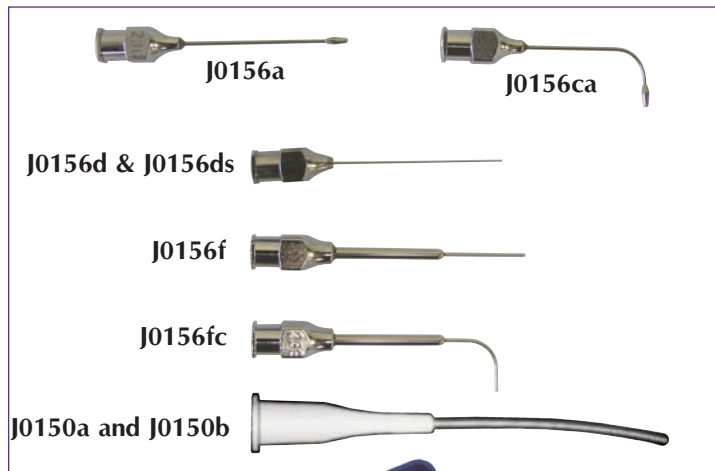

**J0231gs Graefe Iris Forceps.** Serrated. Straight. 4".  
**J0231gc Graefe Iris Forceps.** Serrated. Curved. 4".

**J0231 Castroviejo Needle Holder.** Specially designed for ophthalmic surgery. German-made. 14cm (5 1/2").

**J0231e Needle Holder.** Economy.

**J0232 Castroviejo Fixation Forceps.** For suturing the cornea. 1 x 1 delicate teeth. German-made. 3 1/2".

**J0232e Fixation Forceps.** Economy.

**J0232h Bishop Harman Forceps.** Very delicate tissue forceps. 1 x 2 microteeth. German-made. Stainless steel. 3 1/2" (8.5cm).

**J0232c Castroviejo Caliper.** Very fine caliper with set screw, for measurement of 0-20mm. German-made. Stainless steel.

**Lacrimal Needle.** Special tip for easy insertion into lacrimal duct. Luer mount fits any syringe. Olive tip. Stainless steel.

**J0156a Needle.** Straight. 0.60mm x 30mm (~23g).

**J0156ca Needle.** Curved. 0.60mm x 30mm (~23g).

**Blunt End Needle** without olive tip. Stainless steel shaft and luer lock fitting.

**J0156d Needle.** 23g x 1" (2.5cm).

**J0156ds Needle.** 30g x 1" (2.5cm).

**Blunt End Needle.** Shaft proximal portion reinforced.

**J0156f Needle.** Straight. 23g x 3/4" (~2cm) reinforced shaft 1/2" (1.3cm) extension.

**J0156fc Needle.** Angled. 23g x 3/4" (~2cm) reinforced shaft 5/8" (1.6cm) extension.

**Irrigating Cannula.** These plastic cannula are used for irrigation of the lacrimal ducts, wounds, glands, etc. Rounded ends. Flexible tip. Sterile. 5/pkg.

**J0150a Cannula.** Small. (.76mm o.d. x 32mm).

**J0150b Cannula.** Large. (.91mm o.d. x 32mm).

**J0664k Ophthalmic Surgery Pack.** Kit contains the specialized instruments necessary to complete the more common eye surgical procedures. Just wrap with drape. 6" x 4" x 3/4".

Includes:

**J0232 Castroviejo Forceps.** 1 x 1 micro teeth. Very delicate.

**J0068d Chalazion Forceps.**

**J0068gw Eyelid Retractor.**

**J0231 Castroviejo Needle Holder.**

**J075iwc Iris Scissors.** Curved. 4 1/2".

**J055ga #3 Scalpel Handle.** Uses #15 scalpel blade. (not pictured)

**J0664t Autoclave Tray** with rubber mat.

**J0664 Ophthalmic Surgery Pack** without sterilizing tray.

*NOTE: Items can also be purchased separately.*

**J0506 Schiötz Tonometer.** The most economical method for measuring ocular pressure. Kit comes complete with conversion chart and storage case. German-made.



J0506

**J0992 Indirect Viewing Lens.** Aspheric 20 diopter hand held lens. This 20 diopter all glass indirect convex lens combined with a source of direct illumination i.e. bright penlight allows for 'indirect' ophthalmoscopy of the fundus. The veterinarian holds the lens in front of the animal's eye. At arm's length, the veterinarian direct light at lens:

- Provides a larger field of view of the fundus than is possible with a standard ophthalmoscope
- Exam at safe distance with fractious animals
- Comes with blue velour storage bag

2 1/2" d x 1/2" thick



J0992

**NEW**

**Veterinary Ophthalmic Implants.** *Clients value their pets' appearance ... shouldn't their veterinarian?* The surgical enucleation of a pet's eye is a disheartening procedure. The pet owner is often more traumatized than the pet itself. Part of the surgeon's responsibility is creating the best possible post operative appearance. The most common type of procedure is the transpalpebral approach. This technique requires the placement of an orbital implant to look cosmetically pleasing. With no implant, there will be a marked indentation as the potentially vacant space contracts.

The **Ophthalmic Implants** are:

- Simple to use by any surgeon
- Quality silicone from Dow Corning
- Lightweight and easily sterilized by autoclaving
- Inexpensive implant cost
- Black glossy color
- Multitude of sizes
- Manufactured in the U.S.A. at an FDA inspected facility

Sizing guideline: measure the distance across the cornea then subtract 2mm.

<b>J1244b</b>	12mm	<b>J1244k</b>	28mm
<b>J1244c</b>	14mm*	<b>J1244m</b>	36mm
<b>J1244d</b>	16mm*	<b>J1244n</b>	43mm
<b>J1244e</b>	18mm*	<b>J1244p</b>	47mm
<b>J1244f</b>	20mm*	<b>J1244q</b>	52mm
<b>J1244g</b>	22mm*	<b>J1244r</b>	60mm
<b>J1244h</b>	24mm		

\*most popular. Custom hand-painted units available. Call for information



J1244 series







*NOTE: Specify **Left** or **Right** when ordering.  
The protective ball cup is securely sewn in place and is not interchangeable.*

**JorVet EyeSaver™**, the ultimate in eye care, features the exclusive Equine Eye Patch.

**EyeSaver's Eye Patch** effectively closes the horse's eye for maximum pain relief while allowing for constant monitoring of the injury or problem. EyeSaver affords the eye the most complete rest possible, eliminating the need for surgical closure. Don't let minor injuries become major problems — order your EyeSavers now. You'll be glad you did.

**EyeSaver Kit** contains:

- EyeSaver hood • 3 tear pads • 3 snap-on rings • 25 gauze pads

- J0477r Eye Saver Kit.** Standard. Right.
- J0477L Eye Saver Kit.** Standard. Left.
- J0478r Eye Saver Kit.** X-Large. Right.
- J0478L Eye Saver Kit.** X-Large. Left.
- J0479r Eye Saver Kit.** Foal/Weanling. Right.
- J0479L Eye Saver Kit.** Foal/Weanling. Left.
- J0478xr Eye Saver Kit.** XX-Large. Right.
- J0478xL Eye Saver Kit.** XX-Large. Left.
- J0478ds Double-sided Eye Saver Kit.** X-Large.
- J0478xLds Double-sided Eye Saver Kit.** XX-Large.
- J0479ds Double-sided Eye Saver Kit.** Foal/weanling.
- J0477ds Double-sided Eye Saver.** Standard.

**J0479d Tear Duct Kit.** Includes 3 snap-on rings, 3 tear pads, and 25 gauze pads 4 x 4.

**Subpalpebral Ocular Lavage Kit.** A silicone catheter that is surgically placed with a tunneling trocar into the subpalpebral. The special base lays flat against the mucosa, allowing ease of administration of medication for extended periods in serious ophthalmic condition. Sterile kit includes:

1. silicone lavage catheter. 90cm (36") long.
2. trocar
3. blunt tipped needle (for insertion into catheter)
4. injection cap

- J0150 5fr catheter kit**
- J0150c 8fr catheter kit**

See complete directions at [www.JorVet.com](http://www.JorVet.com)

**EyeSaver™ FEATURES:**

- VELCRO HALTER STRAPS ATTACH TO HALTER
- PADDING
- PAPPED SNAP-ON RING
- DISPOSABLE STERILE GAUZE PAD
- WASHABLE REMOVABLE TEAR PAD
- PADDING
- VELCRO JOWL STRAPS

**EyeSaver™ WITH HALTER**  
(HALTER NOT INCLUDED)

**FRONT VIEW**      **SIDE VIEW**

PROTECTIVE VENTILATED BALL CUP

HALTER STRAPS KEEP HOOD IN PLACE

*No Eye-Saver can be returned for credit that contains animal hair and/or skin debris. We will dispose of it.*

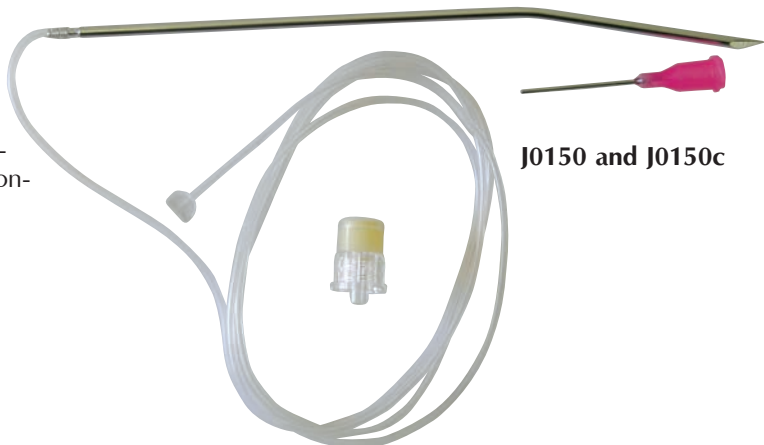

**NEW**

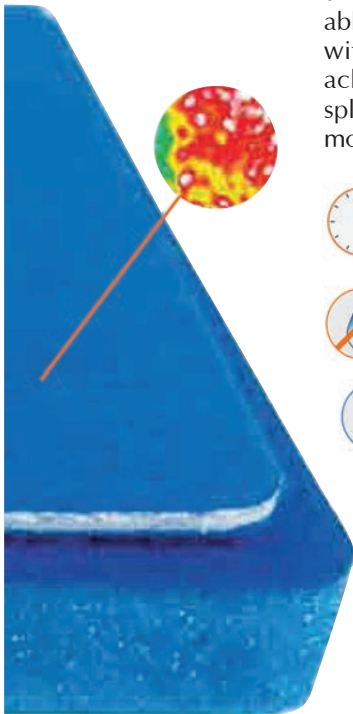

**Rapid Splint System. The latest innovation in splinting and casting . . .**

**Vetexos Rapid Splints™** use an innovative technology previously only available in the orthopedic market. This thermoformable innovation eliminates water activated applications. The removable open-cell foam padding replaces cast padding and can be washed and air dried, or replaced with Vetexos Replacement Padding. **Vetexos Rapid Splints™** can be reheated and trimmed to achieve the perfect fit. Splints come pre-sized providing an off-the-shelf solution to veterinary splinting and casting. The speed and efficiency provided by this technology can save time and money over the leading casting materials. Vetexos products are like nothing else you've tried.



**Fast and Efficient.** Depending on size, splints are fully moldable in 3-5 minutes, and become hands-off rigid in 4 minutes. By eliminating extra steps, the **Rapid Splint™** provides a splinting solution in half the time of traditional splinting.



**Clean and Dry Application.** Formed with dry heat technologies, **Rapid Splints™** eliminate the mess and moisture associated with plaster and fiberglass.



**Lightweight.** Rapid Splints are lightweight, enhancing patient comfort.



**Open-Cell Foam Padding.** Eliminate the need for cast padding with the pre-padded open-cell foam option. Enhance patient comfort and increase application efficiency with the **Rapid Splints™** with Padding.



**Easily Cut with No Sharp Edges.** Sharp edges are eliminated with our pre-cut design. When heated, splints can be easily cut and shaped to create the perfect form and fit.



**Radiolucent.** **Rapid Splints™** are radiolucent, eliminating the need to remove the support for X-ray imaging.



**Vetexos Rapid Splint™ with Padding, 5 per pack, blue**

- J1364 **Vetexos Rapid Splint™ Starter Kit Package with Oven\***
- J1364A **Vetexos Rapid Splint™ with Padding – 2" x 10"**
- J1364B **Vetexos Rapid Splint™ with Padding – 3" x 12"**
- J1364C **Vetexos Rapid Splint™ with Padding – 3" x 36"**
- J1364D **Vetexos Rapid Splint™ with Padding – 4" x 13"**
- J1364E **Vetexos Rapid Splint™ with Padding – 4" x 36"**
- J1364F **Vetexos Rapid Splint™ with Padding – 5" x 13"**
- J1364G **Vetexos Rapid Splint™ with Padding Extra – 3" x 26"\***
- J1364H **Vetexos Rapid Splint™ with Padding Extra – 4" x 26"\***
- J1364J **Vetexos Rapid Splint™ with Padding Extra – 5" x 26"\***

\*Kit includes J1364A, J1364B, J1364C, J1364F, J1364BD1, J1364FD1

\*\*Extra Version features a thicker core, 0.110" vs. 0.05", creating a more rigid, stable splinting device.

**Vetexos Rapid Splint™ Replacement Padding, 5 per pack, blue**

- J1364AD1 **Vetexos Replacement Padding – 2" x 10"**
- J1364BD1 **Vetexos Replacement Padding – 3" x 12"**
- J1364CD1 **Vetexos Replacement Padding – 3" x 36"**
- J1364DD1 **Vetexos Replacement Padding – 4" x 13"**
- J1364ED1 **Vetexos Replacement Padding – 4" x 36"**
- J1364FD1 **Vetexos Replacement Padding – 5" x 13"**
- J1364GD1 **Vetexos Replacement Padding – 3" x 26"**
- J1364HD1 **Vetexos Replacement Padding – 4" x 26"**
- J1364JD1 **Vetexos Replacement Padding – 5" x 26"**

**Vetexos Rapid Splint™ with Exothermix™ Pack**

- J1365A **Vetexos Exothermix™ Rapid Splint™ – 3" x 12"**
- J1365B **Vetexos Exothermix™ Rapid Splint™ – 4" x 13"**
- J1365C **Vetexos Exothermix™ Rapid Splint™ – 5" x 13"**



**Accessories**

- J1366 **Vetexos Top Loading Oven, white**

**NEW**

**Compression Closures**  
The Boa knob and reel system provides even compression with minute adjustments to accommodate swelling and atrophy.

**Removable Open-Cell Foam Padding**  
Our removable open-cell foam padding increases comfort and improves hygiene. Pads can be removed and washed or replaced as needed.

**Dry Heat Thermoformable**  
Use dry heat technology to spot heat or completely reform to modify fit in areas. This is useful to accommodate areas of irritation or abnormal shape.

**Range of Motion**  
Our custom hinges are made specifically to allow lock-out and range of motion control. They can be adjusted vertically to accommodate various length and size needs.



**Quick Release Closure**  
Boa quick release closure snaps provide an easy open and close system without the use of hook and lock.



**Cranial Cruciate Brace**  
Eliminate the need for cast padding with the pre-padded open-cell foam option. Enhance patient comfort and increase application efficiency with the Rapid Splints™ with Padding.



**Achilles Brace**  
Eliminate the need for cast padding with the pre-padded open-cell foam option. Enhance patient comfort and increase application efficiency with the Rapid Splints™ with Padding.

**Vetexos. Cranial Cruciate Ligament (CCL) Injury.**  
*What is plan B if surgery is not an option?*

CCL is a very common injury in dogs. Surgical repair is a popular choice for treatment, but many times surgery is not an option. The client may not want to pay, or be able to pay, for the cost of surgery or the patient is not a suitable candidate.

**Plan B or non-surgical options have been:**

- Custom brace: expensive, time consuming, and by design, a conservative single patient use.
- NSAIDS: Palliative use of

The innovative solution is the **Vetexos CCL Brace** — an off-the-shelf solution to injury stabilization. The modular system allows a custom fit via:

- **Boa™ closure system:** easy adjustment on tightening or loosening the brace
- **Adjustment hinges** for range of motion
- **Patented thermoform splinting material** can be spot heated to modify shape and fit
- **Protective padding** provides comfort fit and cushion. Can be removed, washed, and replaced to maintain hygiene.

The **Vetexos CCL Brace** was developed by the largest U.S. human brace manufacturer in conjunction with veterinary schools and surgeons. Its development took many years and countless prototypes to finalize the optimum product.

The **Vetexos CCL Brace** can be readily used on other patients helping to reduce its cost. A well designed simple treatment protocol helps the patient's joint stabilize while the body heals. Most treatments last 45 to 60 days in a brace. An active, athletic patient will need longer.

**Indications for use:**

- Nonsurgical stabilization of a CCL injury
- Support of noninjured leg while the other leg recovers from surgery
- Use on surgically treated leg during recovery

**J1360 Vetexos Bracing System. Medium.** Tibial length: 6.5" – 8.25", Thigh Circumference: 11.5" – 18.5" Breed sample: boxer, bull dog, cocker spaniel, Australian shepherd, grey hound. Anti-migrate pads included.

**J1360a Vetexos Bracing System. Large.** Tibial length: 8" – 9.375", Thigh Circumference: 13" – 20.5" Breed sample: boxer, bull dog, cocker spaniel, Australian shepherd, grey hound. Anti-migrate pads included.

**J1360b Vetexos Bracing System. XLarge.** Tibial length: 9" – 10.5", Thigh Circumference: 15.5" – 22.5" Breed sample: boxer, bull dog, cocker spaniel, Australian shepherd, grey hound. Anti-migrate pads included.

For more sizing options, check for information at [www.JorVet.com](http://www.JorVet.com)



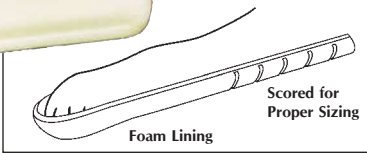
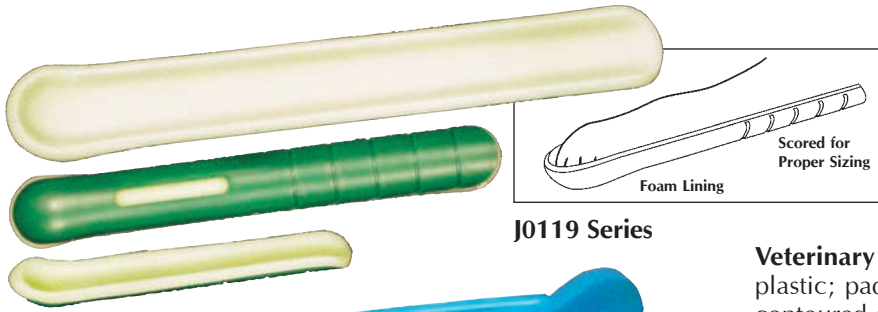

**J0119 Series**

**Veterinary Plastic Splint.** Made of strong, lightweight plastic; padded with non-irritating foam. Splint can be contoured at distal end with addition of moderate heat. Modified cutout for carpal pad. Radiolucent—will not interfere with X-ray while in place. Familiar green color.

- J0119a Plastic Splint.** Small. 1" x 8".
- J0119b Plastic Splint.** Medium. 1 1/2" x 12".
- J0119c Plastic Splint.** Large. 2" x 16".

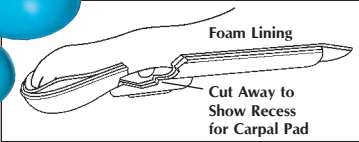

**J0650 Series**

**Carpal Splint.** Made from a heavier material reinforced with longitudinal ribs. A recessed area reduces pressure on the carpal pad. A slight bend in the distal end follows the natural resting position. Splints are provided with open pore foam for comfort. Light blue.

- J0650a Carpal Splint.** Toy. 7 1/2" x 1" x 5/8"D.
- J0650b Carpal Splint.** Small. 10" x 1 1/4" x 5/8"D.
- J0650c Carpal Splint.** Medium. 12" x 1 1/2" x 7/8"D.
- J0650d Carpal Splint.** Large. 15" x 1 7/8" x 7/8"D.
- J0650e Carpal Splint.** X-Large. 18" x 2" x 1"D.
- J0650s Carpal Splints.** Set of 5.

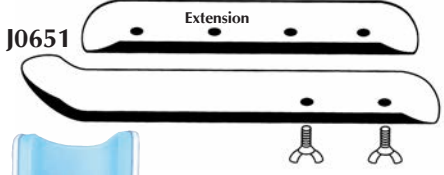

**J0651**

**Metal Mason-Meta Splint.** The original lightweight aluminum splints for lower limb injuries. These splints may be used with an extension if a slightly longer splint is needed. These splints are reusable and designed to last.

- J0651a Splint.** Toy. 1"W 3 1/4"L.
- J0651b Splint.** Toy. 1"W 5 1/4"L.
- J0651bx Splint.** Toy Extension. 1"W 3 1/4"L.
- J0651c Splint.** Small. 1 1/4"W 5"L.
- J0651d Splint.** Small. 1 1/4"W 7"L.
- J0651dx Splint.** Small Extension. 1 1/4"W 4"L.
- J0651e Splint.** Medium. 2"W 7 1/2"L.
- J0651f Splint.** Medium. 2"W 12"L.
- J0651fx Splint.** Medium Extension. 2"W 6 1/4"L.
- J0651g Splint.** Large. 2 1/2"W 14"L.
- J0651gx Splint.** Large Extension. 2 1/2"W 7 1/4"L.
- J0651h Splint.** X-Large. 3"W 16"L.
- J0651hx Splint.** X-Large Extension. 3"W 7 1/4"L.



Post Calving Nerve Injury



**J0927 Series**

**"Bos" Lower Leg Splint.** A heavy-duty reinforced rigid PVC splint with closed cell foam lining. Especially designed for use in larger animals with flexor tendon or lower leg nerve injuries. Placed on the back of the leg and held in place with bandage material (not included).

- J0927 Calf.** Green, hindleg. 40cm.
- J0927a Cow.** Small. Blue. 47cm.
- J0927b Cow.** Large. Orange. 51cm.
- J0927c Cow.** XL (Purple) 54cm.
- J0927e Calf.** Front leg (Yellow)



Contracted Flexor Tendon in Newborn Calf



NOTE: Also available in right or left leg only kits.  
See price list.

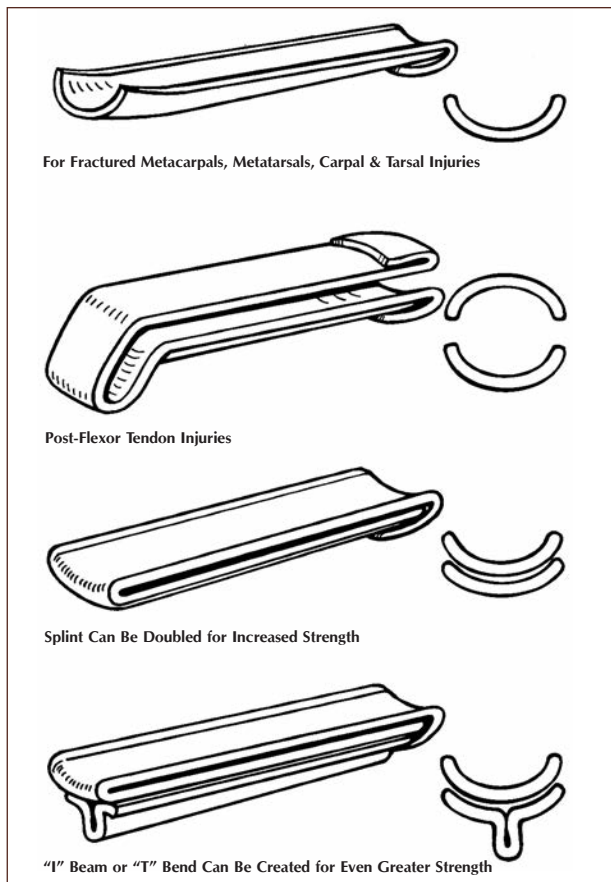

J0289p

**Quick Splint.** The latest design in preformed splints for small animal use, it is made of high impact ABS plastic and is scored for individual sizing. Radiolucent. Excellent replacement for Thomas Schroeder splints. All splints come in a paired left and right leg set.

**Rear Leg or Tarsal Splint.** Shaped to follow hock contour.

- J0119q **Splint.** Cats and small dogs. 9" pr.
- J0119r **Splint.** Medium dogs. 12" pr.
- J0119s **Splint.** Large Dogs. 16" pr.

**Front Leg Splint.** Extends up and beyond the shoulder and down below the carpus.

- J0119x **Splint.** Cats and Small Dogs. 12" pr.
- J0119y **Splint.** Medium Dogs. 16" pr.
- J0119z **Splint.** Large Dogs. 20" pr.

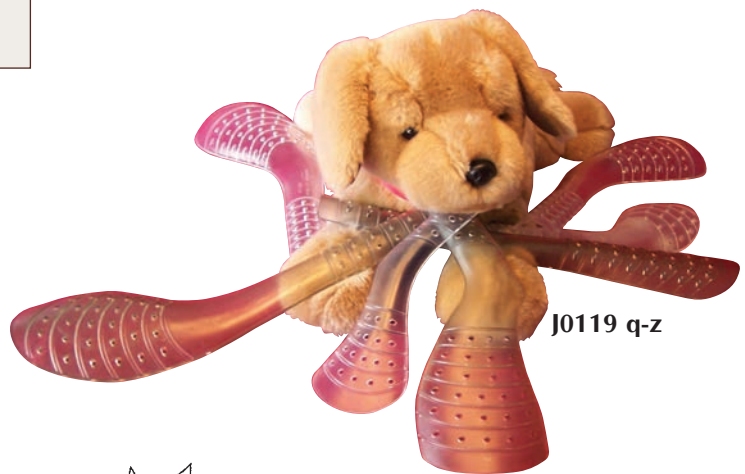

J0119 q-z



J0289

The **SAM® SPLINT** is a closed-pore, foamed, coated, malleable aluminum product that is so unique it is patented. This lightweight radiolucent immobilization device, well accepted in the human field, has been carefully evaluated and improved to meet the unique requirements of veterinary medicine. Familiar blue and orange color scheme. The **SAM® SPLINT** is the lightweight, universal veterinary splint.

**J0289** **Roll.** 36" x 4 1/4".

**J0289p** **Small Paw Splint.** 2" x 4 1/4". 5 1/2 ozs. 10/pkg.

- Washable, not affected by water, disinfectants, or temperature extremes.
- Compact. May be stored flat or rolled
- Easily cut with ordinary scissors
- Radiolucent



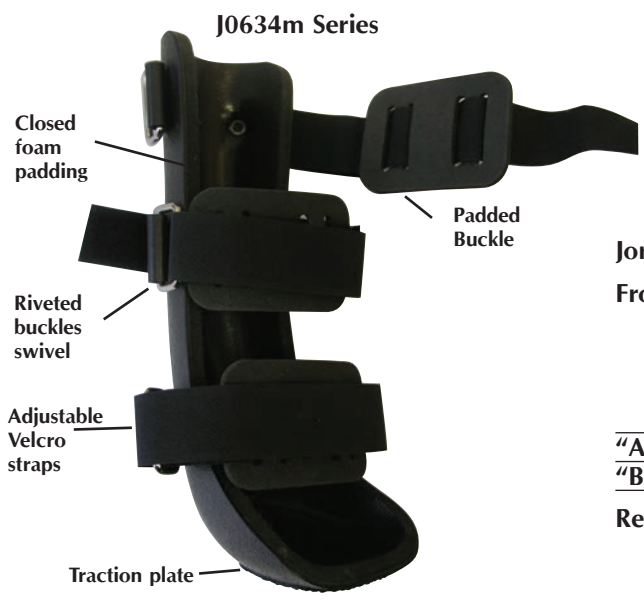
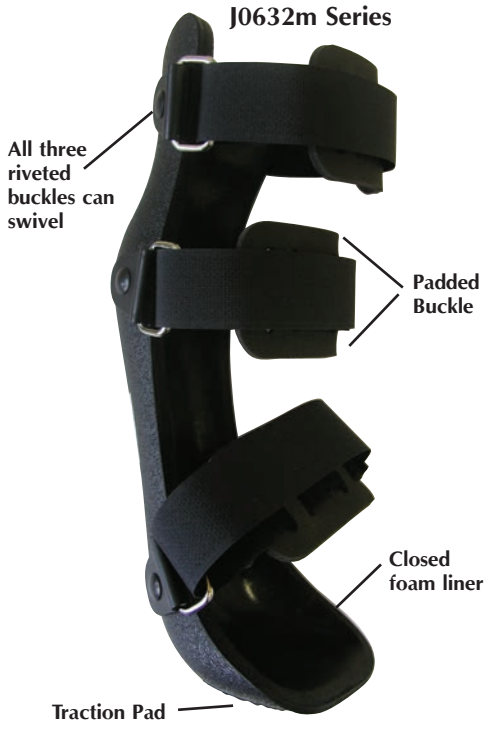

**JorVet Pet Brace.** Improved over previous splints. Modeled after human braces popular for foot and ankle injuries plus nerve damage. Limited warranty.

**Product Construction:**

- Molded polypropylene shell
- Closed-cell foam adheres to shell
- Three 1" velcro straps that are riveted but can still swivel
- Non-slip traction grip on bottom of splint

**Product Design:**

- Splint is placed behind leg and velcro straps are tightened over front of leg
- Velcro straps allows quick on/off for bandage change or healing assessment
- Designed to fit body contours
- Back leg splints extend above hock
- Both leg splints extends completely under the foot
- Splint can be trimmed down to re-shape
- Splints are non-returnable for hygienic reasons.

**J0633m Feline Front Leg Splint.**  
**J0633ma Feline Back Leg Splint.**

**Front Leg Splint.**

<b>J0634m</b>	<b>Splint.</b> X-Small.	5 1/2"H.
<b>J0634ma</b>	<b>Splint.</b> Small.	6 1/2"H.
<b>J0634mb</b>	<b>Splint.</b> Medium.	7 1/2"H.
<b>J0634mc</b>	<b>Splint.</b> Large.	8 1/2"H.
<b>J0634md</b>	<b>Splint.</b> X-Large.	9 1/2"H.

**Rear Leg Splint.**

<b>J0632m</b>	<b>Splint.</b> X-Small.	7"H.
<b>J0632ma</b>	<b>Splint.</b> Small.	8"H.
<b>J0632mb</b>	<b>Splint.</b> Medium.	9"H.
<b>J0632mc</b>	<b>Splint.</b> Large.	11"H.
<b>J0632md</b>	<b>Splint.</b> X-Large.	12 1/2"H.

**JorVet Pet Brace Sizing Information:**

**Front Leg Splints**

	XX-Large *Custom-Made. For dogs 130lb up	X-Large For dogs 85-120lb	Large For dogs 65-85lb	Medium For dogs 40-65lb	Small For dogs 25-40lb	X-Small For dogs 10-25lb	Feline For Cats & Small dogs less than 10lb
<b>"A"</b>	17"	12"	11"	10.5"	9"	7.75"	5.5"
<b>"B"</b>	10.5"	7.25"	7"	6"	5.25"	4.25"	3"

**Rear Leg Splints**

	XX-Large *Custom-Made. For dogs 130lb up	X-Large For dogs 85-120lb	Large For dogs 65-85lb	Medium For dogs 40-65lb	Small For dogs 25-40lb	X-Small For dogs 10-25lb	Feline For Cats & Small dogs less than 10lb
<b>"A"</b>	20"	16"	14"	11"	10"	9.5"	6.25"
<b>"B"</b>	14.5"	11.25"	9.25"	8"	7"	6.5"	4.25"

**How to Measure:**

**For Front Leg Splints**

**"A" Measurement:** This measurement is the total length of the splint. Using a flexible tape measure, begin by placing it under the animals foot and measuring from the longest toe nail extending up the back of limb to mid-forearm. (place the limb as if the animal were in a standing position)  
**Note:** The splint will not extend up and over the elbow.

**"B" Measurement:** This measurement is taken from the Carpal Pad (at the wrist) down the back of the limb and under the foot to the longest toe nail. (Place the limb as if the animal were in a standing position)

**For Rear Leg Splints**

**"A" Measurement:** This measurement is the total length of the splint. Using a flexible tape measure, begin by placing it under the animals foot and measuring from the longest toe nail extending up the back of the limb, over the Hock to just below the dogs knee. (Place the limb as if the animal were in a standing position.)  
**Note:** The splint will not extend or support injuries to the animals Knee or Stifle.

**"B" Measurement:** This measurement is taken from the Hock and extending down the back side of the limb, under the foot to the longest toe nail. (Place the limb as if the animal were in a standing position)



**J0668 Tail Splint.** A four-finger malleable aluminum splint with blue foam padding. This splint fits over the end of the tail and is taped in place. 2"L (5cm). 3/pkg.

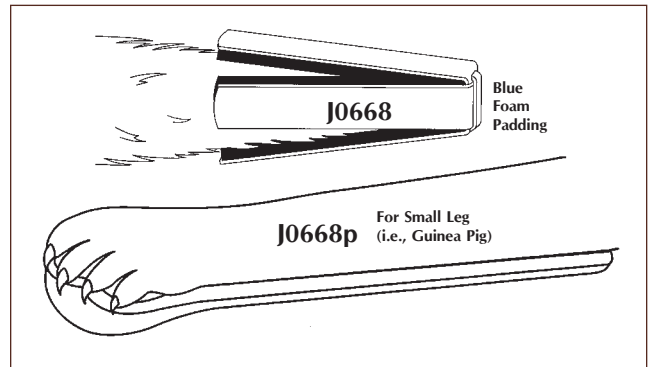

**J0668p Super Petite Spoon Splint.** This very small splint is a malleable aluminum with blue 0.5cm (1/4") thick foam padding. The distal tip has a slight bend to give the spoon shape. Can be trimmed to shape. 1.5cm (0.6")W x 11cm (4.4"). 3/pkg.

**Aluminum Splint Rod.** Ideal for veterinarians who wish to save money by making their own splints. Available in 3 sizes. 6'L. 24/case. (not pictured)

**J0261a Splint Rod.** 3/16" x 6'.

**J0261b Splint Rod.** 1/4" x 6'.

**J0261c Splint Rod.** 3/8" x 6'.

**J0261sb Splint Rod Bender.** Taking a straight aluminum rod and making a usable T-splint is a real challenge without a splint rod bender. The JorVet splint rod bender helps anyone make the proper shape for any size animal or any type of splint configuration.

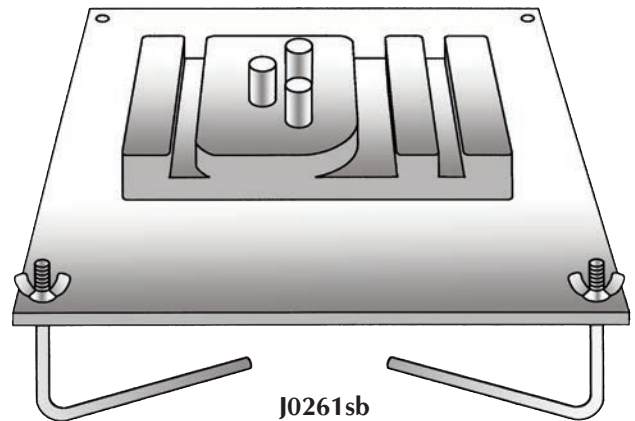



J0940k

**Custom Splints.** Design is limited only by your imagination.

Wide variation in size and shape of patients makes splinting a challenge. Thermoplastic sheets offer the ideal solution. Widely used with human patients, these splint materials are now adapted to make custom splints and braces that partially or totally immobilize any animal patient's body part.

Custom splints and braces are formed from thin, flat, thermoplastic sheets. Heated in hot water, the sheets become soft and pliable, allowing trimming and molding to any body part for a perfect custom fit. Hook and loop straps hold the splint in place. Padding/liner materials increase patient comfort.

These splints are adaptable, inexpensive, and relatively easy to make.

**Marq-Easy Thermoplastic Splint Sheets.** Solid construction 1/8" thick splint sheets offers superior rigidity and tensile strength (180,000 psi), making it ideal for weight-bearing splints in small and large animals (i.e., medium to large dogs, horses, and livestock). The tough, rubber-based material makes a strong, rigid splint, drapes well over contours and bony areas, and adheres to itself when heated to reinforce or patch splint. Radiolucent. Tan.

- J0940a 1/8" Thick Splint Sheet. 4"x 9". For narrow, long legs.
- J0940b 1/8" Thick Splint Sheet. 6" x 12".
- J0940c 1/8" Thick Splint Sheet. 12" x 24".

**J0940k Thermoplastic Splinting Starting Kit** provides all the basic components to get started with thermoplastic splinting. A wide range of applications can be accomplished with the materials provided along with the comprehensive CD ROM.

Kit includes (see following pages for item specifics):

- J0940b Marq Easy 1/8" Thick Splint Sheet. 6" x 12".
- J0940g Marq Easy 1/16" Thin Splint Sheet. 6" x 9".
- J0940w Polycushion 1/8" Thick Padding. 18" x 24".
- J0940x Compact Foam 3/8" Thick Padding. 16" x 24".
- J0940s Clear Thera-Gel 1/8" Thick Sheet.
- J0940v Soft Padded Velcro Strapping. 1"W.
- J0940t Soft Padded Velcro Strapping. 2"W.
- J0940cd Instructional CD ROM.
- J0921bc Cotton Stockinette 2" x 25 yd. (also in kit)

**One Percent Perforation 1/16" Thin Splint Sheets** drapes easily over small, contoured and recessed areas, making it ideal for smaller animals including small dogs, cats, birds, and exotics. Perforations allows body surface to breathe and makes the splint lighter. Adheres to itself when heated.

- J0940f 1/16" Thin Splint Sheet. 4"x 6".
- J0940g 1/16" Thin Splint Sheet. 6" x 9".
- J0940h 1/16" Thin Splint Sheet. 9" x 12".

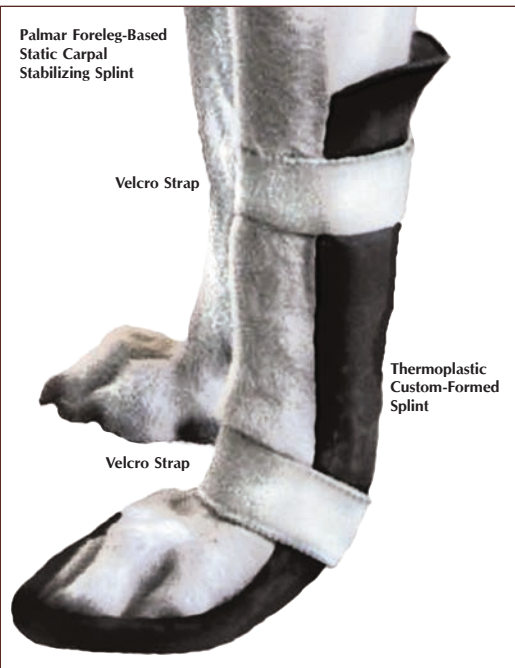



J0940s



J0940w



J0940y



J0940y



J0291 Series

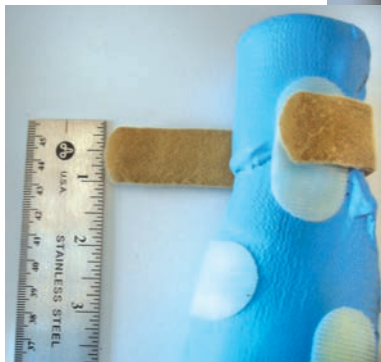

J0940v



J0940t

**Liners and Padding.**

**J0940s** **Clear Thera-Gel 1/8" Thick Sheet** with self-adhesive back. Cut to fit to protect bony prominences and sensitive areas. Contains mineral oil to help soften and protect delicate skin. Washable with soap and water. *Latex-free.* 4" x 4".

**J0940w** **Polycushion 1/8" Thick Padding** with self-adhesive back. Closed-cell, soft construction. Adheres to splint sheet prior to heating in water. *Applying this padding on splint sheet prior to heating in water takes longer to soften (~5 minutes).* For all-purpose use. Wipes clean with damp cloth. *Latex-free.* Tan. 17 3/4" x 24".

**J0940x** **Compact Foam 3/8" Thick Padding** with self-adhesive back. Open-cell, slow-recovery construction. Medium-density, compact foam molds with body heat to contour body parts. Use to pad the splint for increased patient comfort. *Contains some latex.* Blue. 16" x 24".

**J0940y** **Thin Fleece Liner** with self-adhesive back. Open-cell, extremely softweave. Mild stretch makes it easier to line intricate spaces and contours for use with smaller animals, including small dogs, cats, birds, and exotics. Useful to pad strapping material and for covering minor creases in splints. *Latex-free 100% cotton.* Pink. 9" x 16".

**Stockinette** is useful for protecting extremities prior to splinting. Use as non-adhesive liner under a splint for small and large animals. Stockinette is removable and washable.

**J0291b** **Polyester Stockinette.** 2" x 25 yd.

**J0291c** **Polyester Stockinette.** 3" x 25 yd.

**J0291d** **Polyester Stockinette.** 4" x 25 yd.

**J0291e** **Polyester Stockinette.** 6" x 25 yd.

**J0291ac** **Cotton Stockinette.** 1" x 25 yd.

**J0291bc** **Cotton Stockinette.** 2" x 25 yd.

**J0291cc** **Cotton Stockinette.** 3" x 25 yd.

**J0291dc** **Cotton Stockinette.** 4" x 25 yd.

**J0291ec** **Cotton Stockinette.** 6" x 25 yd.

**Strapping.**

**J0940v** **Soft Padded 1" Width Velcro Strapping.** Non-stretching and lightly padded material. For small animals and discreet areas that do not require splint support to help hold the splint in proper position.

Kit includes: 1" x 36"L strap and 12" hook patch with self-adhesive back side. Both can be trimmed to customize the splint.

**J0940t** **Soft Padded 2" Width Velcro Strapping.** Useful for larger animals or to disperse pressure over larger surface areas.

Kit includes: 2" x 36"L strap and 12" hook patch with self-adhesive back side. Both can be trimmed or thinned as needed.

**J0940cd** **Instructional CD ROM** on basic splinting techniques and procedures.



**J0412x** "T" Bar handle hex head screw driver for 2.7/3.5/4.0mm screws, has 2.5mm hex head.

**Hex Head Drive Shaft.** This hex drive shaft fits into any standard Jacob's Chuck to give power when placing hex head screws. Finally tightening should be done by hand.

**J1089** 2.5mm hex drive for 2.7/3.5/4.0mm hex head screws.  
**J1089a** 3.5mm hex drive for 4.5/5.5mm hex head screws.

**Hex Screwdriver and Screw-Holding Sleeve.** Screwdrivers with screw-holding sleeves hold the screw until it has engaged in the threaded hole. The sleeve slides back up the shaft to release the screw without disengaging it.

**J0412a** Hex Screwdriver for 2.0mm screw, with sleeve.  
**J0412b** Hex Screwdriver for 2.7mm, 3.5mm, and 4.0mm screw with sleeve.  
**J0412c** Hex Screwdriver for 4.5mm and 5.5mm screw.  
**J0412cs** Sleeve for hex screwdriver above.  
 (For use on hex head screws.)



**J1233** Screwdriver with Quick Release Handle and Rotating White Teflon Cap. This driver allows the use of one handle to interchange with a variety of insert shafts from hex head to the newer star drive headed screws.

**J1233a** Drive shaft for 2.7/3.5/4.0mm hex drive screws  
**J1233b** Drive shaft for 4.5/6.5mm hex drive screws  
**J1233c** Drive shaft for 2.0mm star drive locking screws  
**J1233d** Drive shaft for 2.4/2.7mm star drive locking screws  
**J1233e** Drive shaft for 3.5mm star drive locking screws



**Depth Gauge.** Accurate measurement of hole depth is essential to select the appropriate screw length. A range of gauges is available for the various screw sizes. Hole depth is read from the instrument. Remember to add plate thickness if necessary.

**J0410a** Depth Gauge for 2.0mm screw. Range 6–20mm.  
**J0410** Depth Gauge for 2.7–4.0mm screws. Range 6–40mm.



**Load/Neutral Drill Guide.** To exert compression at a fracture site, the pilot bit must be positioned precisely in the slot in the compression plate. The load/neutral drill guide has two sleeves, one for compression (load) and one where no compression is exerted (neutral). There is one combined guide for each screw size.

**J0411** Load/Neutral Drill Guide for 2.0mm plates. Uses 1.5mm pilot drill.  
**J1073Lng** Load/Neutral Drill Guide for 2.4mm plates. Uses 1.8mm drill bit.  
**J0411b** Load/Neutral Drill Guide for 2.7mm plates. Uses 2.0mm pilot hole drill bit.  
**J-411c** Load/Neutral Drill Guide for 3.5mm plates. Uses 2.5mm pilot hole drill bit.  
**J-411d** Load/Neutral Drill Guide for 4.5mm plates. Uses 3.2mm pilot hole drill bit.

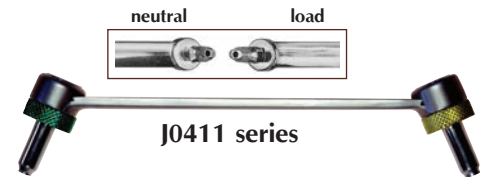

**Drill Guide and Insert.** This drill guide enables the surgeon to align the entry and exit points of the drill bit.

**J0414** Drill Guide. Small. 3.5mm i.d. For 3.5mm drill bit and 3.5/2.0, 3.5/2.5, 3.5/2.7mm insert sleeves.  
**J0414e** Drill Guide. Large. 6.5mm i.d. For use with J-414g insert sleeve and 4.5mm screw system.

**Insert Sleeves (for drill guide) and when placing screws in lag configuration.**

	O.D.	I.D.	For Screw:
<b>J0414a</b>	3.5mm	2.0	3.5mm Cancellous <b>J0423a-s*</b>
<b>J0414aa</b>	2.0mm	1.5	2.0mm Cortical <b>J0416 a-j</b> . Fits inside <b>J-414a</b> .
<b>J0414b</b>	3.5mm	2.7	3.5mm Self-Tapping <b>J0406a-o*</b>
<b>J0414bb</b>	3.5mm	2.5	3.5mm Cortical <b>J0421 a-j*</b>
<b>J0414f</b>	6.5mm	4.5	for use with Drill Guide <b>J0414e</b>
<b>J0414g</b>	4.5mm	3.2	4.5mm Cortical Screw <b>J0426a-L</b> plus Drill Sleeve <b>J0414f</b>

\*Use J0414 drill guide

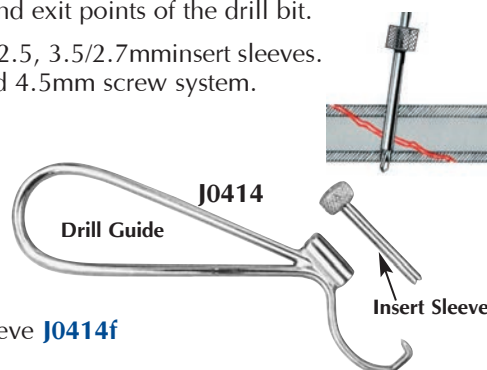

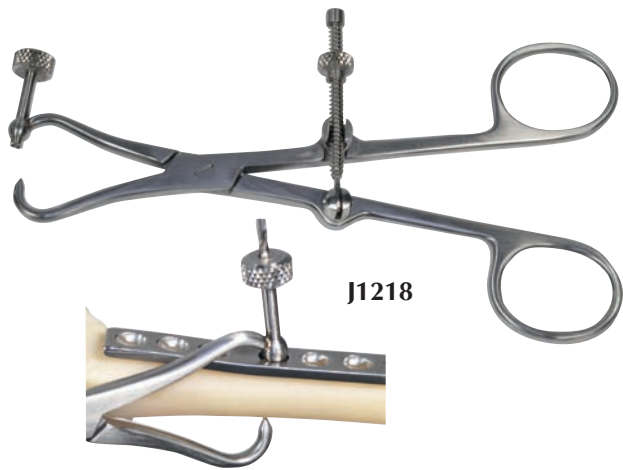

J1218



J0415

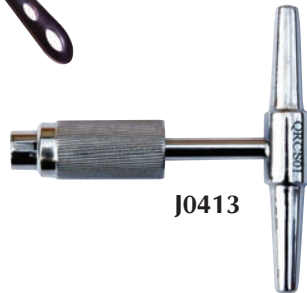

J0413

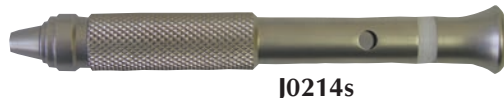

J0214s

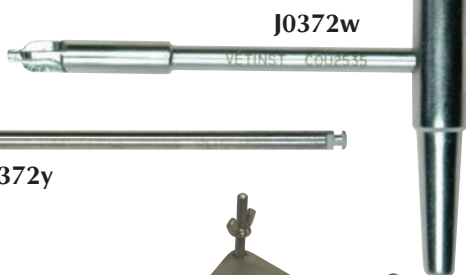

J0372w



J0372y

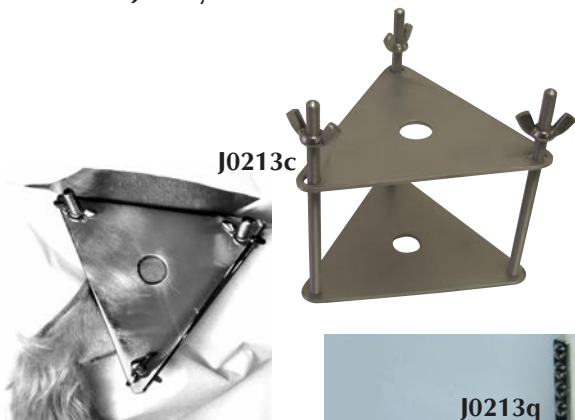

J0213c



J0213q

**Plate Holding/Drill Guide Forceps.** Temporary fixation of a bone plate at a fracture is an essential part of bone plating. Unfortunately there is an equal desire for the placement of bone reduction forceps and drill guides. The new range of JorVet bone holding/drill guide forceps attempts to address two of these requirements. All DCPs and many other plates are designed to hold and interact with spherical headed bone screws. This range of forceps has a spherical ball tip on one side of the jaw and a pointed tip on the other to allow the maximum range of positions for each forcep without compromising the reduced fracture. Incorporated into the ball tip is a drill guide of an appropriate size which just protrudes through the ball to engage in the bone under the plate. As pressure is applied the ball tip engages the edges of the plate hole producing a secure fix of the plate on the bone with a drill guide in situ, hands free ready for drilling. The pointed tip is offset relative to the drill guide to prevent contact between drill tip and forceps. Available for 1.5/2.0, 2.4/2.7 and 3.5 screws and plates.

- J1218** Plate Holding and Drill Guide Forceps. 1.5/2.0mm
- J1218a** Plate Holding and Drill Guide Forceps. 2.4/2.7mm
- J1218b** Plate Holding and Drill Guide Forceps. 3.5mm
- J1218c** Set of all 3 sizes.

**Soft Tissue Protection Sleeve.** Rotating pins, drills and taps will "pick up" soft tissue, skin, muscle, nerves and blood vessels, causing serious damage. Use of tissue protection sleeves minimizes such damage. The teeth at the top of the guide locate on the bone while the stainless steel tube provides a barrier between soft tissue and implant equipment.

- J0415a** Sleeve for drill/taps to 2.0mm.
- J0415b** Sleeve for drill/taps to 2.7mm.
- J0415c** Sleeve for drill/taps to 3.5mm.
- J0415d** Sleeve for drill/taps to 4.5mm.

**J0413** Quick Release Tap Handle Synthes Fit.  
Fits all taps 2.7mm, 3.5mm, 4.0mm, and 4.5mm.

**J0214s** Tap Handle for 2mm taps with latch fit. 4" length.

**Countersinks.** This instrument contours the top of the screw hole to fit the screwhead. It is used for lag screw procedures and for the reattachment of small bone fragments.

- J0372w** Small countersink 2.7/3.5 and 4.0mm screw heads with T-handle
- J0372y** Large countersink 4.5 and higher screw. Quick coupling end
- J0409lh** Large countersink with T-handle

**J0213c** Condyle Clamp. An improvement over the old style rectangular plexi-glass condyle clamp. This triangular, stainless steel, two-sided clamp fits over the humeral condyles and allows greater alignment. A lag screw can be inserted through the hole in the middle of the triangular plate. Reduction may be checked by radiography prior to lag screw fixation. Pressure should be applied proximo-laterally not just purely laterally.

**J0213q** Small Lowman Bone Clamp. Developed from standard human Lowman clamp. This clamp grips bone up to 15mm diameter and will also hold small plates in position. 3" (70mm) length.

**Bone Fragment (Reduction) Forceps.** Fragment forceps are used for temporary accurate reduction of fragments while implants are being applied.

**J0212s Small Fragment Forceps.** 5<sup>1</sup>/<sub>4</sub>". Very small fragments (e.g., malleolar fractures in cats) require appropriate instrumentation. The fine ratchet on these forceps allows very precise closure. The tips are stepped down to very accurate reduction without over penetration.



**J0212m Fragment Forceps.** Medium. 135mm.  
**J0212x Pointed Reduction Forceps with Spin Lock.**



Where delicate reduction of fragments is undertaken, ratchet forceps can be frustrating in that they do not give as much "feel" as is desirable. The spinlock version is used initially with the spinlock flipped out giving the surgeon maximum control. Once in place the spinlock is flipped back into position and then gently tightened. 5<sup>1</sup>/<sub>2</sub>" length.

**J0212 Fragment Forceps.** Standard. 6" (15cm).

**J0212L Fragment Forceps.** Extra Large. 8". May be used to provide temporary stabilization of osteotomy while the plate is contoured and placed.

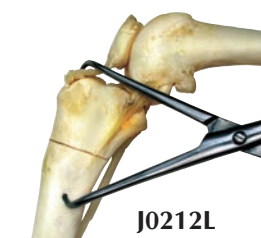

**J0212Ls Fragment Forceps.** Large. Spin lock closure. 7<sup>1</sup>/<sub>2</sub>". Especially useful in the TTO and TTA procedures.



**Twin Point Fragment Forceps.** Single pointed reduction forceps typically apply pressure at the exact point where it is desirable to place an implant. Splitting the tips allows implants to be placed at the ideal position (e.g., repair of lateral condyle fractures).



**J0212ts Twin Point Fragment Forceps.** Straight tip. 6<sup>1</sup>/<sub>2</sub>".

**J0212tc Twin Point Fragment Forceps.** Curved tip. 6<sup>1</sup>/<sub>2</sub>".

**J0213 Bone Holding Forceps.** Stainless steel. 15 cm. 6".

- For small dogs and cats
- Wide jaws offer maximum compression
- Bone screws and pins can be inserted through the center



**J0212p Plate holding forceps.** These forceps are designed to maintain plate position through a hole in the plate. The ball, just behind the point of the jaw, locates in bone plate screw hole causing minimal interference elsewhere in the operation site. Also, useful as a reduction forceps in soft young bone as the balls prevent over penetration of the bone. 6" (15 cm). Works for 2.7/3.5mm plates.

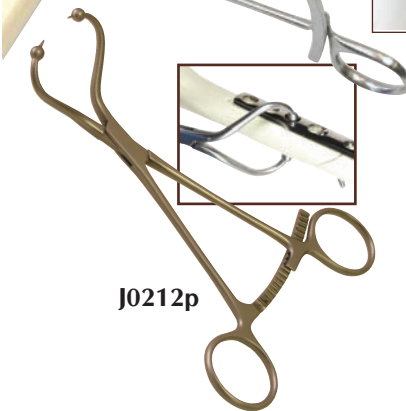

**J0212kL Forceps.** 180mm (7<sup>1</sup>/<sub>2</sub>") Longer length with spinlock. Good for reduction of tibial tuberosity in TTA.



**Verbrugge Bone Holding Forceps.** Preferred instrument for holding bone plates or bone fragments. Self-centering with spinlock. Stainless steel.

**J0213va Bone Holding Forceps.** Small. 150mm (6<sup>1</sup>/<sub>2</sub>") for 2.7 and 3.5mm narrow plates.

**J0213vb Bone Holding Forceps.** Large. 240mm (9<sup>1</sup>/<sub>2</sub>") for 3.5 and 4.5mm plates.

**J0159 Baby Kerns Bone Holding Forceps.** German-made. Stainless steel. 15cm. 6"

**J0159L Kerns Bone Holding Forceps.** Standard. 8" (21cm).

**J0159m Kerns Bone Holding Forceps.** Mini Baby Kerns. 4"L (10cm).

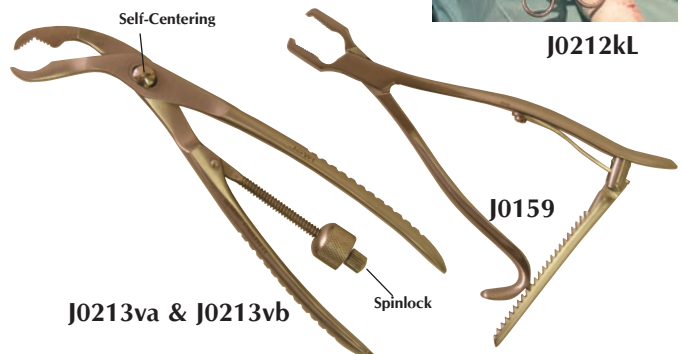



**J0212gs** **Reduction forceps with serrated jaws.** Spin lock. Provides incremental secure control, round ends. 7<sup>1</sup>/<sub>4</sub>".

**J0159rf** **As above.** 6<sup>1</sup>/<sub>2</sub>".



J0212gs  
J0159rf

**J0854** **Extra-Small Bone Clamp.** 5"L. The long bones of cats and very small dogs are difficult to hold and manipulate without crushing or slippage. These new serrated forceps offer maximum grip while supporting the bone.

Ratchet is fine to allow incremental closure. Tips are fine to allow use as small reposition forceps. Stainless steel.



J0854  
Gripping Cat Tibia

**J0854b** **Large serrated bone holding forceps.** 18cm (7<sup>1</sup>/<sub>4</sub>")

**J0854a** **Extra Small Serrated Bone Holding Forceps.** 90mm (3<sup>1</sup>/<sub>2</sub>"). Manipulation of the long bones of cats and small dogs is difficult without crushing. The serrated jaws of this forceps are contoured to maximize grip and support. The tips are sharp. They may be used as small fragment forceps.



J0854a

**J0427** This **Orthopedic Surgical Pack** provides every piece of surgical instrumentation to get started with orthopedic procedures with an emphasis on IM pins and cerclage wires. Includes:

- J0214L** **Jacob's Hand Chuck.**
- J0250** **IM Bone Pin Bag.**
- J0250n** **K-Wires** 0.045"/1.1mm (6).
- J0250p** **K-Wires** 0.062"/1.6mm (6).
- J0228b** **Osteotome.**
- J0107** **Gigli Wire.**
- J0107h** **Gigli Wire Handles** (2).
- J0222** **Bone Curette #0.**
- J0243** **Senn Retractors** (2).
- J0241** **Weitlaner Retractor.**
- J0159L** **Kern's Bone Holding Clamp.**
- J0159** **Mini Kern's Bone Holding Clamp.**
- J0218** **Cerclage Wire Twister and Cutter.**
- J0260b** **Cerclage Wire.** 20g x 10mm.
- J0260c** **Cerclage Wire.** 22g x 10mm.
- J0209f** **Forman Bone Rasp.**
- J0220ba** **Pin Cutter.**
- J0226q** **Freer Elevator.**
- J0224f** **Friedman Ronguer.**
- J0251b** **Part Thread Bone Pin.** 5/64" (2).

- J0251c** **Part Thread Bone Pin.** 3/32" (2).
- J0251d** **Part Thread Bone Pin.** 7/64" (2).
- J0251e** **Part Thread Bone Pin.** 1/8" (2).
- J0251f** **Part Thread IM Pin.** 9/64" (2).
- J0251a** **Part Thread IM Pin.** 1/16" (2).
- J0228m** **Gerzog Mallet.**

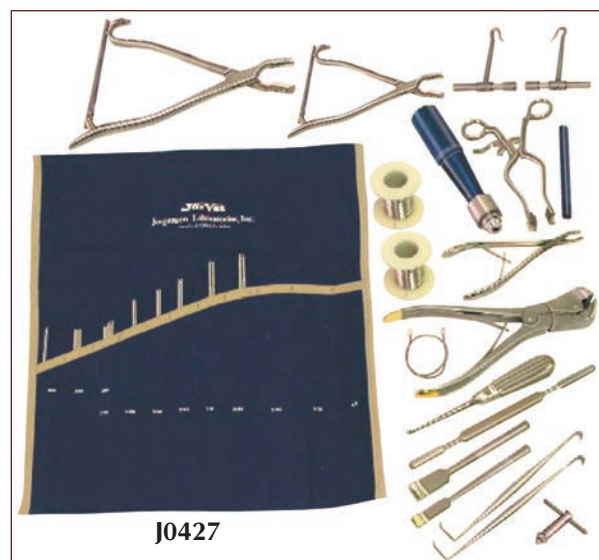

J0427

**J0219** **Adjustable Bone Saw.** The small surgical saw allows a much finer technique than with an osteotome and hammer, especially in more delicate surgeries such as Arnoczky's over the top cruciate repair, tibial crest transplant, trochlear groove remodeling, femoral head excision, and other orthopedic procedures. 15cm–19cm (5<sup>1</sup>/<sub>2</sub>" x 7<sup>1</sup>/<sub>2</sub>").

- Comes with five blades
- Handle is stainless steel, blades are chrome-plated



J0219

**J0219d1** **5 pack of extra blades.**

**J0219x** **Hard-back Orthopedic Saw.** Stainless steel saw with ridged back and is autoclavable. The stiff back helps guide the saw compared to hacksaw-type blades, which often deviate. 140mm long x 23mm deep with 0.4mm cut.



J0219x

**Adjustable Drill Guide.** Designed to ensure accurate positioning of drill holes prior to inserting screws or prostheses. The pointed end is placed at the desired destination for the drill bit. The body of the device is tightened at the point of entry. Device includes 3 drill sleeves: 3.5mm, 2.5mm, and 2.0mm.

- J0414h** **Adjustable Drill Guide.** 3.5mm, 2.5mm and 2.0mm sleeves.
- J0414hL** **Adjustable Drill Guide.** 4.5mm sleeve.
- J0414hx** **Drill Guide Attachment** for use with J-414hL 5.5mm sleeve (equine) 13cm length spread.

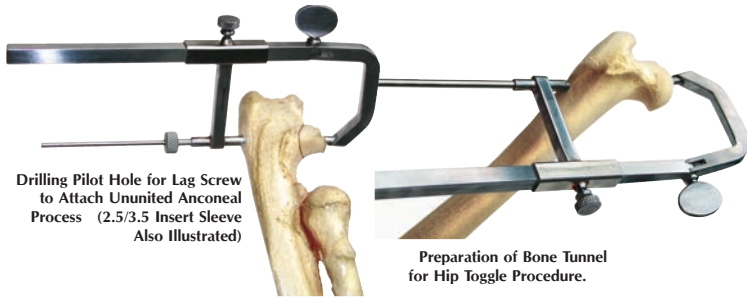

**J0414h & J0414hL**



*NOTE: See page 178 for insert sleeves that can be used in conjunction with the provided sleeves.*

- J0444k** **IsoToggle Starter Kit includes:**
- J-444f** **LigaFiba IsoToggle suture** 250 lbs (2)
- J-444g** **LigaFiba IsoToggle suture** 500 lbs (2)
- J-372cx** 2.5mm drill x 120mm
- J-372fxl** 3.5mm drill x 180mm
- Priced so **J-444g** 500lb IsoToggle system is free!

Step by step guidelines available  
 The LigaFiba can be readily tied by the toggle button  
 Toggle buttons also available separately.

**Isotoggle Buttons.** Non sterile. Can be safely autoclaved.

- J0444n** **Toggle Button** large 11mm
- J0444p** **Toggle Button with slots** large 11mm
- J0863x** **Toggle Button** medium 8mm
- J0863y** **Toggle Button with slots** medium 8mm

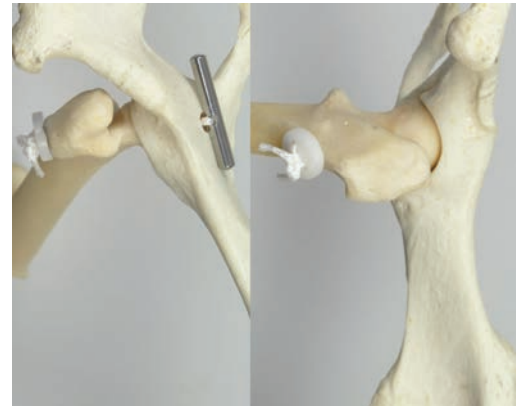

**Toggle Insertion System.** The hip toggle is a well-proven method of management of coxo-femoral luxations. A tunnel is drilled up through the femoral head and neck, plus through the acetabulum where the round ligament normally attaches. The toggle is placed through the acetabulum. It turns cross ways on the medial side of the pelvis. LigaFiba runs the length of the tunnel and tension is applied to the toggle, keeping the hip in place.

**Toggle Insertion Device.** The toggle insertion process is commonly difficult due to use of home-made or other commercial devices. Typically problematic is the toggle coming back out of the hole in the acetabulum. The toggle insertion device deposits the toggle reliably and safely into the pelvic canal through the 4.5mm hole in the acetabulum. Pulling back on the LigaFiba while retaining the insertion device in the hole “flips” the toggle preventing pullout.

The LigaFiba line which passes through the hole in the toggle is passed down through the drilled hole in the femoral head and neck. Use of an adjustable drill guide (**J-414h**) ensures accurate placement of this hole.

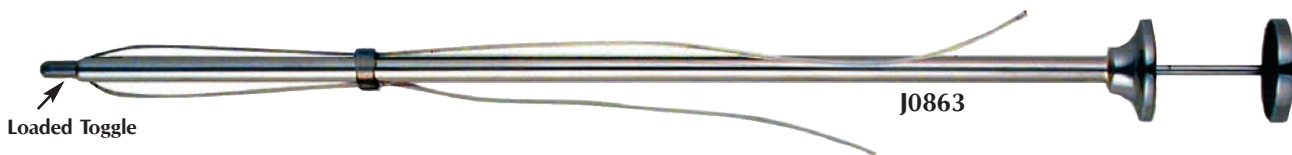

- J0863** **Toggle Insertion Kit.** Includes insertion device and one sterile toggle with 250 lb. LigaFiba and button.
- J0863t** **Insertion Toggle.** Double-wrapped in sterile pouch with LigaFiba (**J04444**) and omrod button

**J0863k** **Deluxe Toggle Kit** includes everything needed for this procedure: J-863t (5), J-414h, and J-863x (5)

**J0414h** **Drill Guide.**

**J0863** **Toggle Insertion Kit** with 1 toggle.

**J0863t** **Insertion Toggles** (5) with toggles and LigaFiba line. Sterile.

**LigaFiba is a braided polyethylene suture and now is used in preference to monofilament nylon. It is up to 15 times stronger and more resistant to flex fatigue.**

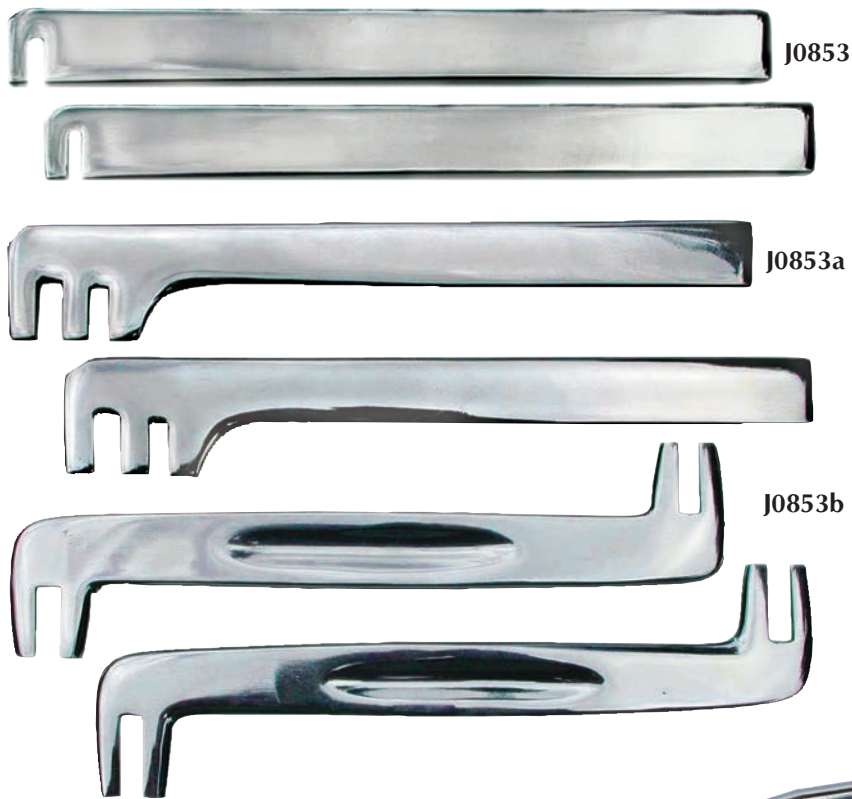

From the smallest to the largest, Jorvet offers a wide range of **Bone Plate Benders**. Proper contouring of bone plates is a necessity for proper reduction of fractures. Used in pairs, bone plate benders are the most cost-effective method of plate contouring. Stainless steel.

- J0853 Small Bender.** 1.5mm/2.0mm. Used for small 1.5/2.0mm plates. 140mm L. Pr/Pk.
- J0853a Bender.** 2.7mm/3.5mm. Used for 2.7mm and 3.5mm narrow plates. 140mm L. Pr/Pk.
- J0853b Bender.** 4.5mm. Used for 3.5mm broad and 4.5mm plates. 200mm L. Pr/Pk.



**J0852 Plate Bending Pliers.** Double-sided roller-type. Used for 3.5mm narrow, 3.5mm broad and 4.5mm narrow plates. Stainless steel with aluminum handles. 15" (380mm) L.



**J0852a Reconstruction Plate Pliers.** Used for 3.5mm reconstruction plates. Stainless steel. 290mm L.

- J0375 Bone Washer.** Plain bone washers. Stainless steel.
- J0375f** plain washer 1.5/2.0/2.2mm screw
- J0375g** plain washer 2.7mm/3.5mm/4.0mm screw
- J0375h** plain washer 4.5mm screw
- J0375j** plain washer 2.4mm screw



**J1210 Table Top Stand for Limb Suspension.** Suspension of a limb can provide significant benefits in both arthroscopy and other orthopedic procedures. the shoulder joint is distracted and 360-degree access becomes available. Height 48" (1.2 meter). Adjustable.





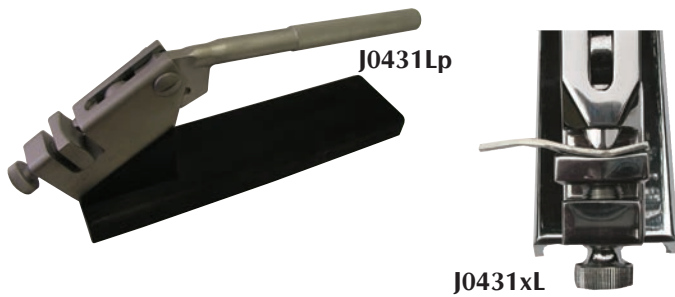

**J0431Lp Large Bone Plate Press.** The JorVet Bone Plate Press is designed for small animal plates and will fit in your autoclave. Works on 2.7-4.5 narrow plates 12" long.

**J0431xL Extra-Large Bone Plate Press.** Very large 16" (410mm) overall length. Suitable for 2.7-4.5mm broad plates. Wide anvil.

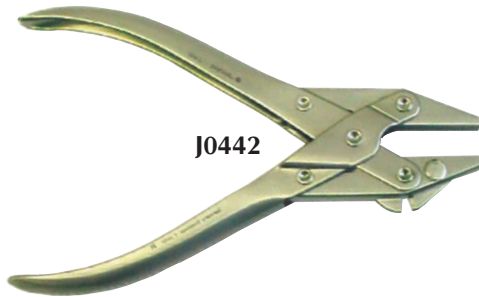

**J0442 Parallel Action Twister/Cutter. Pin** removal is made easy with this forceps. Also useful for bending, holding, and cutting small pins and wires. Parallel action pliers may be used in tandem with bone plate bender for contouring smaller plates. Stainless steel. Maximum size wire is 1.6mm.

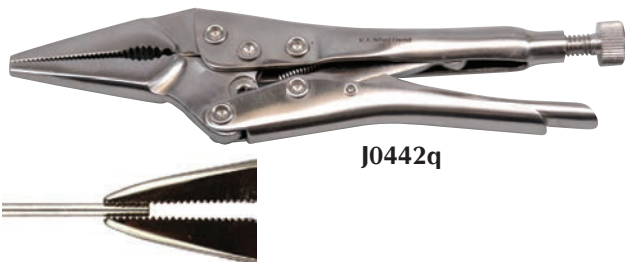

**J0442q Vise grip style pin removal forceps.** Familiar "lock on" vise grip action. The tips are small for minimal trauma and grooved for maximum grip on pins. Will work on pin sizes 5/64" to 1/4" (2.4mm to 6.25mm). Stainless steel 7" (175mm).



**J0854x Plate Bending Pliers TPLO Guide Wire Bender.** Contours 2.7/3.5mm narrow bone plates. Also useful for bending guide pins for the TPLO technique. Stainless steel with satin finish.

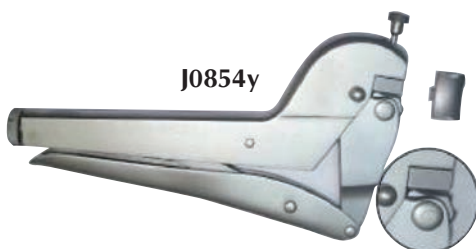

**J0854y Heavy Duty Bone Plate Pliers.** The largest bone plate pliers in the range, these will contour all plates other than the 4.5 broad. The bending head has 3 interchangeable anvils and the 'hammer' side has 3 different shapes which rotate. This offers the surgeon 6 different contouring options to match different plates and different shapes.

**Rongeur.** German-made. Stainless steel.  
**J0225c** **Ruskin.** Curved. 4mm bite. 18cm (7").  
**J0225s** **Ruskin.** Straight. 4mm bite. 18cm (7").  
**J0225L** **Stille-Luer.** Curved. 8mm bite. 22cm (8 1/2").

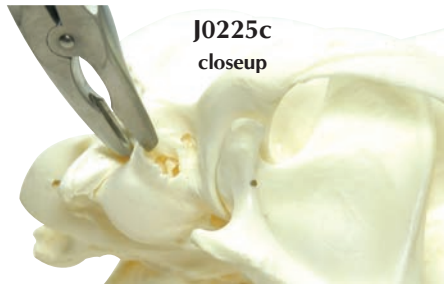

**J0225c**  
closeup  
bulla osteotomy

**J0224** **Duck-Billed Mini-Rongeur.** This X-small rongeur was designed specifically for use in delicate spinal cord surgery. It is especially effective in removing the final layer of bone overlying the spinal cord in laminectomy procedures. Stainless steel. 2mm bite. 5 1/4".

**J0224c** **Small Angled Ronguers.** Slightly curved head useful for a wide range of orthopedic procedures including bone spurs on a total femoral head and neck excision. 4mm bite, 6 1/2" (170mm).

**J0224f** **Micro Friedman Rongeur.** Very delicate. 5 1/2" (14cm) curved jaw. 1.3mm W.

**J0225e** **Ecklin-Duckbill Rongeur.** Double action. 3mm bite. 8 1/2".

**J0226** **Key Periosteal Elevator.** Slightly curved blade. German-made. Stainless steel. 190mm. (7 1/2").

**J0226a** **Elevator.** Blade, 6mm.

**J0226b** **Elevator.** Blade, 12mm.

**J0226c** **Elevator.** Blade, 19mm.

Recommended for periosteal stripping in foals.

**Periosteal Elevator.** A popular configuration available in either 6mm curved tip (most popular) or 6mm square tip. Lightweight fiber handle 180mm. (7 1/2").

**J0226s** **Curved** 6mm tip. Replaces J-226p. Most popular.

**J0226r** **Square** 6mm tip.

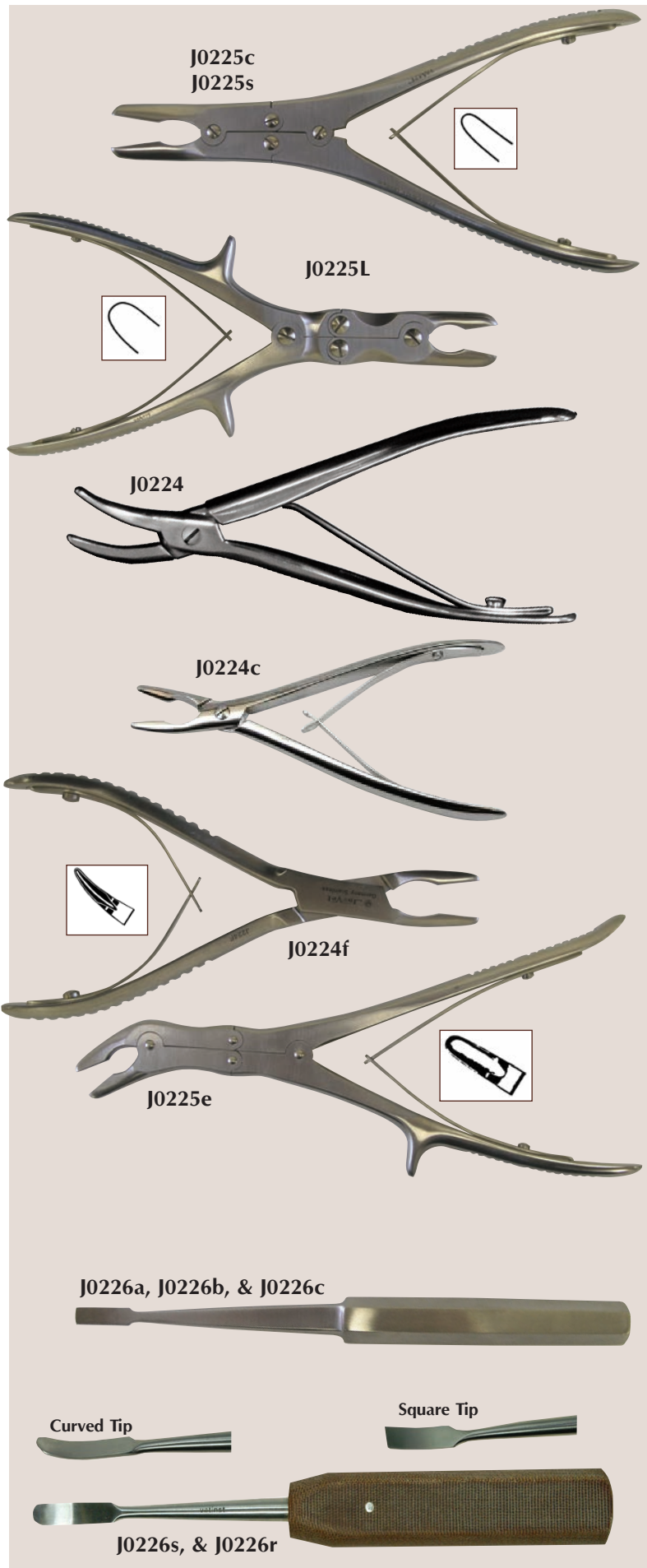



J0227a & J0227b



J0228a & J0228b



**U.S. Army Pattern Chisel.** Striking button for easier use with Gerzog mallet. German-made. Stainless steel. 17cm L (6<sup>1</sup>/<sub>2</sub>").

**J0227a Chisel.** Blade, 6mm W.  
**J0227b Chisel.** Blade, 12mm W.

**Jorgensen Osteotome.** Shorter length for finer control, suggested for femoral head removal. German-made. Stainless steel. 13.5cm (5").

**J0228a Osteotome.** Blade, 10mm W.  
**J0228b Osteotome.** Blade, 16mm W.

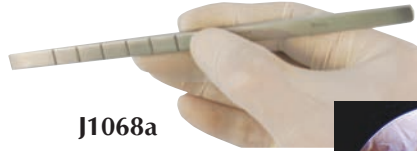

J1068a

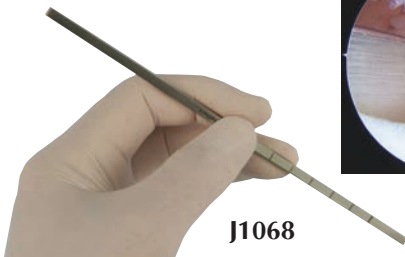
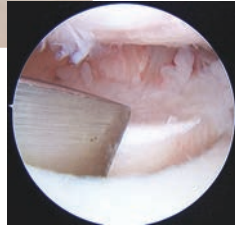

J1068

**J1068a Super slim block resection osteotome.** A very slim and thin osteotome 8mm (1/3"). Block resection of the shallow trochlea preferred by many surgeons. A standard osteotome is too thick resulting in more bone breakage. Follow with a J-209F square Foman rasp to clean up the corners.

**J1068 Gordon Coronoid Osteotome.** Designed and developed by Ian Holsworth, this narrow slim osteotome is used for arthroscopic sub total coronoidectomies.

**Modular osteotome:** a comfortable autoclavable teflon handle with metal end to take hammering Blade 1.1mm in thickness. This makes them a great choice for procedures like block sulcoplasty. The blades can be changed intra operatively for proper fit during the procedure. Supplied as a complete kit with 7 different blades or purchase handle and blades separately.



J1233

**J1068h Modular osteotome** handle only and screw driver for changing blades

- J1068ma blade only** 4mm
- J1068mb blade only** 6mm
- J1068mc blade only** 8mm
- J1068md blade only** 10mm
- J1068me blade only** 12mm
- J1068mf blade only** 15mm
- J1068mg blade only** 20mm
- J1068mk handle and set of all 7 blades,** includes screw driver



J1068h series

**J1233 Modular Diamond Rasp**



J0215m

'Stubby' Pin Punch

**'Stubby' (Short) Instruments.** The reduced working length allows the stubby punch to be held between thumb and forefinger much closer to the patient for increased control. The punch is now close enough for other fingers of the hand to support the bone. This is especially useful when working without an assistant. 50mm long.

**J0215m Stubby Pin Punch (overall length 50mm)**  
**J0228c Stubby Osteotome 6mm x 70mm long**  
**J0228d Stubby Osteotome 10mm x 70mm long**

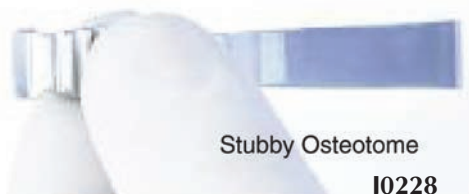

Stubby Osteotome

J0228



**J0223 Liston Bone Cutting Forceps.** Single action forceps. German-made. Stainless steel. 5 1/2".

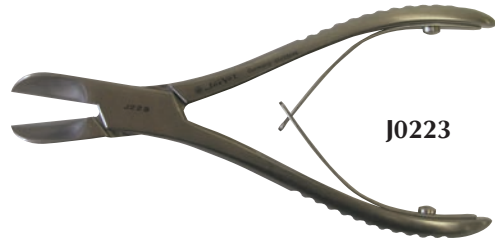

J0223

**J0223s Small Angled Bone cutter.** Especially useful for small dogs and cats. The jaws have the ideal size and angle for:

- Femoral head and neck excision
- Tibial crest translocation
- Many other small bone cutting procedures

15mm blade. 6 1/2" (170mm) length.



J0223s



**Ruskin-Liston Bone Cutting Forceps.** Double action forceps. German-made. Stainless steel.

**J0223a Bone Cutting Forceps.** 5 1/2".

**J0223b Bone Cutting Forceps.** 7 1/2".

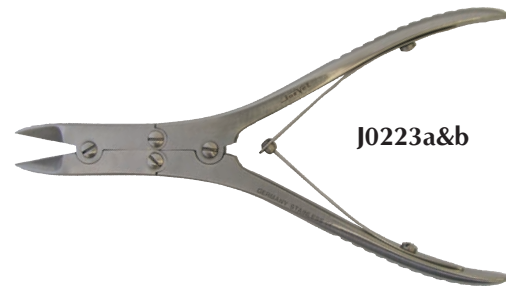

J0223a&b

**J0222h House curette.** To lift bone around the spinal cord. Double-ended 2.5 + 3.0mm scoops.



J0222h

**Volkman Bone Curette.** Excellent for OCD lesions. Oval cutting surface. German-made. Stainless steel. 22cm.

**J0222 Bone Curette.** Size #0. (7mm x 8mm).

**J0222a Bone Curette.** Size #3/0. (3mm x 5mm).

**J0222b Bone Curette.** Size #2. (8mm x 11mm).

**Hatt spoon/bone curette.** An alternative to the disarticular in large dogs. The edge of the spoon is very sharp. A fiber handle for balance. 230mm (9.4") Oval shaped scoop.

**J0222n** 17mm x 30mm scoop

**J0222p** 12mm x 18mm scoop

**J0222q** 7mm x 12mm scoop



J0222 Series



J0222n/p/q

**J0226q Freer Elevator.** Knurled double-ended elevator with curved fine spatula tips. Useful for lifting of tissue layers. Stainless steel. German-made. 7" (18cm).

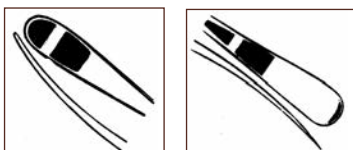

J0226q



- J0107** **Gigli Wire.** Gigli wire and handle sold separately. 52cm (21").
- J0107h** **Gigli Wire Handle.** Gigli wire and handle sold separately.
- J0107m** **Modified Gigli Bone Saw Handle.** Locking clip holds wire in proper position.

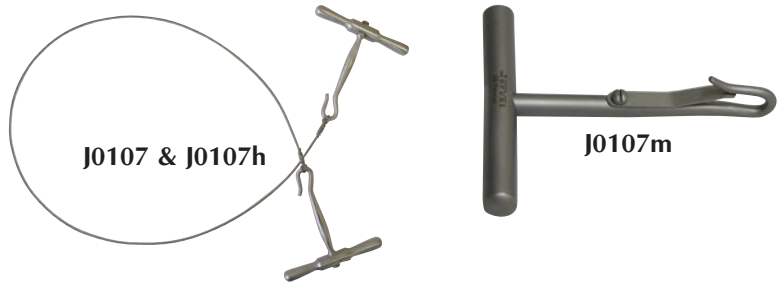

- J0209** **Excision Arthroplasty Rasp.** The fine head on the rasp allows easy removal of bone spurs or rough edges in a femoral head excision. The rasp cuts only on the backward stroke. Stainless steel. 17cm (6.5").

- J0209f** **Foman Bone Rasp.** Double ended rasp with convex and flat files. teeth are coarse on one side and fine on the other side. 8 1/4" (21cm). Use with J-1068 Osteotome block resection sulcoplasty.

- J0210** **Trochlear Rasp.** Designed especially for remodeling the femoral trochlear groove in patella luxation. The varying cone-shape diameter allows the surgeon to make the patella fit precisely. Stainless steel. 17cm (6.5").

- J0228x** **Mead Orthopedic Mallet** with hardened nylon face. Replaceable 26mm dia. mallet face. Weighs 320gm. 6 3/4" (17cm) L.

- J0228xd1** **Spare Face.**

- J0228m** **Gerzog Orthopedic Mallet.** Hollow handle with 16 oz. lead-filled head. 25 x 35m head. German-made. 18cm (7 1/4"). Stainless steel.

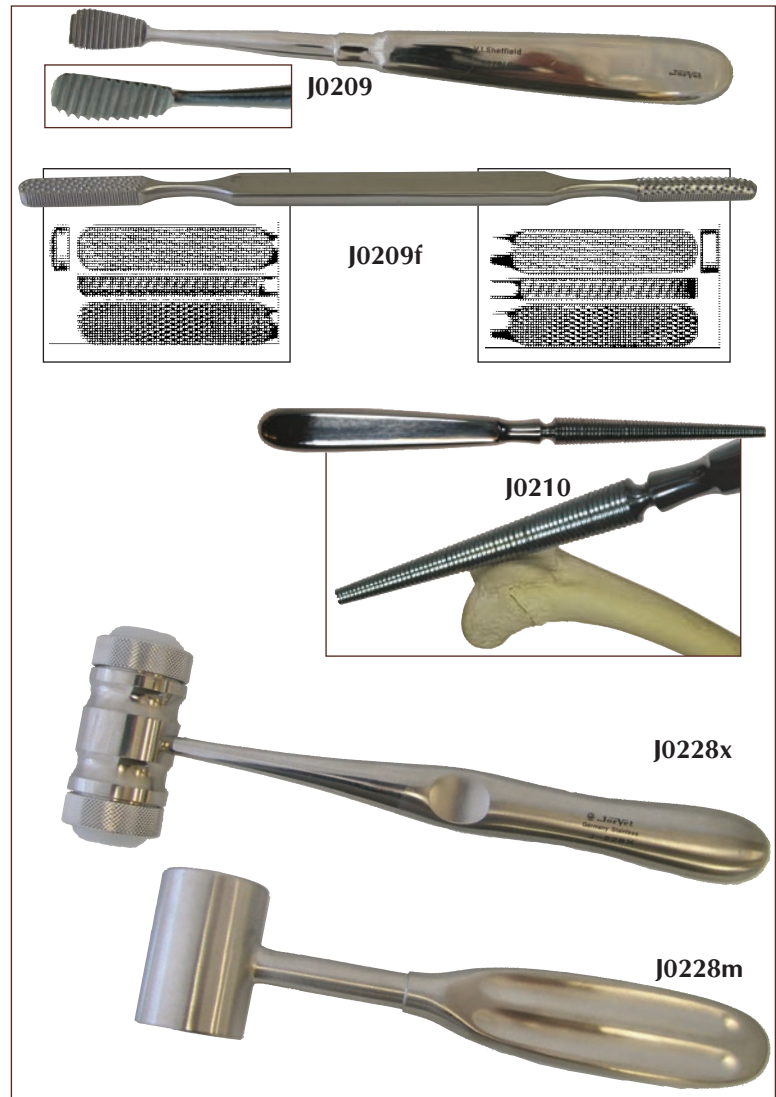

- J0250q** **K-wire Dispenser.** This dispenser holds the fine orthopedic K-wires. In surgery packs – 4 separate labeled chambers hold standard "K" wires. Stainless steel and autoclavable. Turn dial to open up and dispense desired size of K-wire.



**JorVet Intramedullary Steinman Pins.** Highest quality type 316L stainless steel IM pins. Available in the points and diameters listed below. When ordering, please match diameter with point style number. Made in U.S.A.

**J0250 Trocar-Trocar.**  
**J0251 Trocar-Screw.**

<b>A</b>	1/16" x 7".	<b>F</b>	9/64" x 9".
<b>B</b>	5/64" x 7".	<b>G</b>	5/32" x 10".
<b>C</b>	3/32" x 8".	<b>H</b>	3/16" x 12".
<b>D</b>	7/64" x 8".	<b>I</b>	1/4" x 12".
<b>E</b>	1/8" x 9".		

**K-Wire or Fine Orthopedic Wire.** Highest quality stainless steel type 316LVM. U.S.A. made. Double Trocar Point. 6/pk.

**J0250m Wire.** .035" x 7".

**J0250n Wire.** .045" x 7".

**J0250p Wire.** .062" x 7".

**J0250 IM Pin Bag.** Autoclavable IM pin bag that allows IM pin organization in a neat and easy-to-find fashion.

**IM Pin Starter Kit.** IM pin starter kit comes with autoclavable pin bag. Please specify IM pin style desired. Kits include:

	Starter Kit	Deluxe Kit
0.9mm — (.035") k-wire	6 ea.	6 ea.
1.1mm — (.045") k-wire	6 ea.	6 ea.
1.6mm — (.062") k-wire	6 ea.	6 ea.
1.6mm — 1/16" IM pin	2 ea.	4 ea.
2.0mm — 5/64" IM pin	2 ea.	4 ea.
2.3mm — 3/32" IM pin	2 ea.	6 ea.
2.6mm — 7/64" IM pin	2 ea.	6 ea.
3.0mm — 1/8" IM pin	2 ea.	6 ea.
3.4mm — 9/64" IM pin	2 ea.	6 ea.
3.8mm — 5/32" IM pin	2 ea.	6 ea.
4.5mm — 3/16" IM pin	2 ea.	4 ea.
6.0mm — 1/4" IM pin	2 ea.	4 ea.

**J0250k Trocar-Trocar Pin Starter Kit.**

**J0250L Trocar-Screw Starter Kit.**

**Deluxe Kit.**

**J0250kd Trocar-Trocar Pin Deluxe Kit.**

**J0250Ld Trocar-Screw Deluxe Kit.**

**IM Bone Pin Tube.** Stores Bone Pins in a stainless steel autoclavable round tube with a screw-on cap.

**J0250x 320mm long x 30mm diameter.**

**J0250y 225mm long x 30mm diameter for "K" wires.**

**J0211 K-Wire Bending Instrument.** A unique tool for bending over the ends of K-wire after various osteotomies (i.e., a greater trochanter osteotomy). Allows just the very tip to be bent over quickly and precisely. Works on all three sizes of K-wire.

**J0211q K-Wire Extraction Forceps.** Designed to firmly grip small (0.9-2.0mm) wires. Tungsten Carbide provides a maximum grip and the fine nose minimizes trauma to the surrounding tissue. 5 1/2".

**J0215 K-Wire Small Pin Punch.** Useful for tapping in exposed cut ends of small bone pins. Knurled handle. Stainless steel. 135mm length.

**J0215a K-Wire Small Pin Punch.** Small. 1.6mm fine tip.

**J0214k Very small pin handchuck/visc.** 3 1/2"L holds small K-wires and pins up to 2.5mm (3/32")

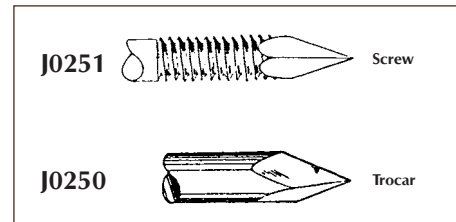

J0250 Starter Kit

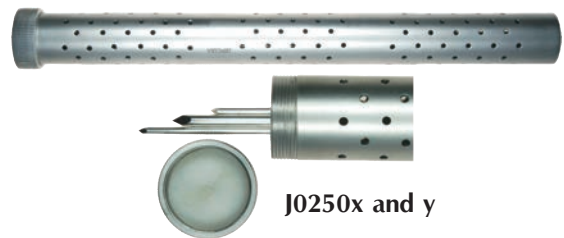
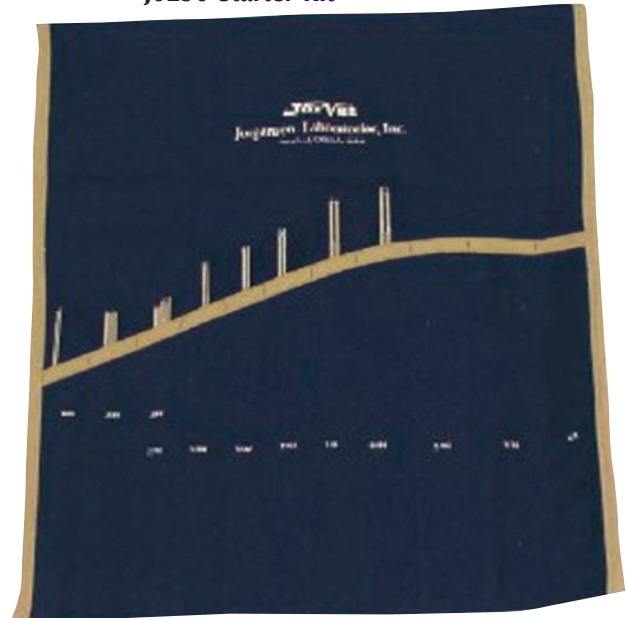

J0250x and y



J0211



J0211q



J0215/J0215a



J0214k



**External Fixation Starter Kit.** Basic kit to provide components enough for any type I frame in small and medium size. Ideal for beginning entry into external fixation.

- |                |   |                 |                                       |
|----------------|---|-----------------|---------------------------------------|
| <b>J0371k</b>  | <b>External Fixation Starter Kit.</b>         | <b>J0371rsb</b> | 1/8" x 2" rods (2)                    |
| <b>J0371s</b>  | Small single clamps (4)                       | <b>J0371rsd</b> | 1/8" x 4" rods (2)                    |
| <b>J0371m</b>  | Medium single clamps (4)                      | <b>J0371rsf</b> | 1/8" x 6" rods (2)                    |
| <b>J0371ds</b> | Small double clamps (2)                       | <b>J0371rmc</b> | 3/16" x 4" rods (2)                   |
| <b>J0371dm</b> | Medium double clamps (2)                      | <b>J0371rme</b> | 3/16" x 6" rods (2)                   |
| <b>J0371pa</b> | 3/32" External fixation pins (4)<br>pt. thrd. | <b>J0371rmg</b> | 3/16" x 8" rods (2)                   |
| <b>J0371pb</b> | 1/8" External fixation pins (4)<br>pt. thrd.  |                 | Small wrench (1)<br>Medium wrench (1) |

**KE Starter Kit** with raised (positive) threaded pins.

- |                 |   |  |
|-----------------|---|--|
| <b>J0371xa</b>  | <b>Small Pin Kit.</b>                           |  |
| <b>J0371s</b>   | <b>8 Small Single Clamps.</b>                   |  |
| <b>J0371f</b>   | <b>4 Positive Profile End-Threaded,</b> small.  |  |
| <b>J0371a</b>   | <b>4 Positive Profile Mid-Threaded,</b> small.  |  |
| <b>J0371rsf</b> | <b>2 Connecting Bars.</b> 6"L.                  |  |
| <b>J0372b</b>   | <b>Drill Bit.</b> 5/64".                        |  |
| <b>J0371xb</b>  | <b>Medium Pin Kit.</b>                          |  |
| <b>J0371m</b>   | <b>8 Medium Single Clamps.</b>                  |  |
| <b>J0371g</b>   | <b>4 Positive Profile End-Threaded,</b> medium. |  |
| <b>J0371b</b>   | <b>4 Positive Profile Mid-Threaded,</b> medium. |  |
| <b>J0371rmg</b> | <b>2 Connecting Bars.</b> 8"L.                  |  |
| <b>J0372d</b>   | <b>Drill Bit.</b> 7/64".                        |  |



**KE Plus Pin Clamp.** Kirschner-Ehmer (KE) external fixation is a versatile system that has stood the test of time. Recent recommendations include the use of positive or raised profile pins. Traditional or standard KE clamps are difficult to use with positive profile pins. Also, standard KE clamps can only be used with one size pin. The new KE Plus Clamp can be used with positive profile and various sized pins.

		Largest Thread/Shank	Smallest Thread/Shank
<b>J0371aq</b>	<b>Pin Clamp.</b> Small.	3.6mm (9/64")	0.9mm (1/16")
<b>J0371bq</b>	<b>Pin Clamp.</b> Medium.	4.8mm (3/16")	2.4mm (7/64")
<b>J0371cq</b>	<b>Pin Clamp.</b> Large.	6.5mm (1/4")	3.0mm (1/8")

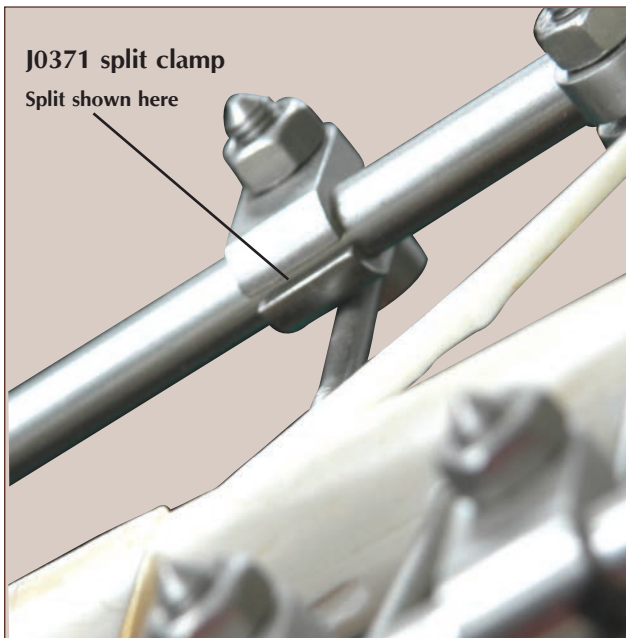
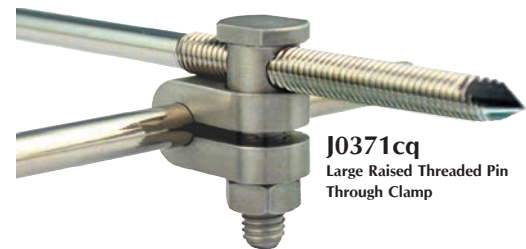

**KE Split Clamp.** The reduction and stabilization of complicated fractures is a time consuming procedure. If additional clamps and pins are found to be needed during surgery the whole frame must be disassembled. The split clamp allows the addition of clamps at any time during the surgery. A centrally placed washer increases holding power.

- |                 |                             |
|-----------------|-----------------------------|
| <b>J0371scs</b> | <b>Split Clamp.</b> Small.  |
| <b>J0371scm</b> | <b>Split Clamp.</b> Medium. |
| <b>J0371scL</b> | <b>Split Clamp.</b> Large.  |

JorVet offers a complete line of **External Fixation Equipment**. All fixators are high grade surgical stainless steel and will interchange with other brands of fixators. New aesthetic design combined with a lower cost makes JorVet external fixation equipment the best value.

- J0371s**    **Single Fixation Clamp.** Small.
- J0371m**    **Single Fixation Clamp.** Medium.
- J0371L**    **Single Fixation Clamp.** Large.
- J0371ds**    **Double Fixation Clamp.** Small.
- J0371dm**    **Double Fixation Clamp.** Medium.
- J0371dL**    **Double Fixation Clamp.** Large.

**Type-I Half Pin.** Partially threaded pins engage the cortex and increase the pull out resistance.

- J0371pa**    **Type-I Half Pin.**  $\frac{3}{32}$ " x 4".
- J0371pb**    **Type-I Half Pin.**  $\frac{1}{8}$ " x 4 $\frac{1}{2}$ ".
- J0371pc**    **Type-I Half Pin.**  $\frac{5}{32}$ " x 5".



**External Fixation Rod.** A variety of sizes are offered to work with every case.

Small Rod $\frac{1}{8}$ "D	Medium Rods $\frac{3}{16}$ "D	Large Rods $\frac{5}{16}$ "D
<b>J0371rsa</b> 1 $\frac{1}{2}$ "L	<b>J0371rma</b> 2"L	<b>J0371rLa</b> 4"L
<b>J0371rsb</b> 2"L	<b>J0371rmb</b> 4"L	<b>J0371rLb</b> 6"L
<b>J0371rsd</b> 4"L	<b>J0371rmd</b> 6"L	
<b>J0371rsf</b> 6"L	<b>J0371rmf</b> 8"L	

**Type-I External Fixation Kit.** The pins of Type-I frame pass through both bone cortices. The clamps and connecting rods are assembled only on one side of the injured leg. Type-I Kit contains:

- 6 Single clamps
- 2 External fixation part thread pins
- 2 Double trocar smooth IM pins
- 1 Connecting rod

- J0371ks**    **Fixation Kit.** Small.    Pin,  $\frac{3}{32}$ " dia.            Rod, 6"L.
- J0371km**    **Fixation Kit.** Medium. Pin,  $\frac{1}{8}$ " dia.            Rod, 8"L.
- J0371kL**    **Fixation Kit.** Large.    Pin,  $\frac{5}{32}$ " dia.            Rod, 10"L.

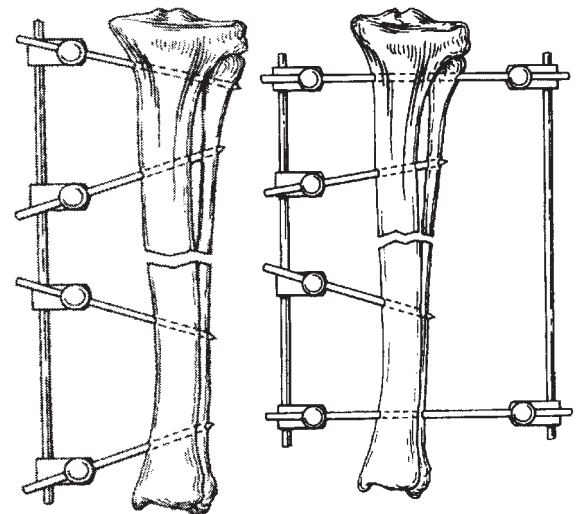

Type I

Type II

**Type-II External Fixation Kit.** The pins of the Type-II configuration pass through two sides of the limb. Clamps are attached to both ends of protruding pins. Type-II kit contains:

- 4 Double trocar IM pins
- 8 Single clamps
- 2 Connecting bars

- J0371kbs**    **Fixation Kit.** Small.    IM pin,  $\frac{3}{32}$ " x 8"            Rod, 6"L.
- J0371kbm**    **Fixation Kit.** Medium. IM pin,  $\frac{1}{8}$ " x 9"            Rod, 8"L.
- J0371kbl**    **Fixation Kit.** Large.    IM pin,  $\frac{5}{32}$ " x 10"        Rod, 10"L.



**Bone Pin Point Cover.** The sharp ends of exposed bone or ESF pins are a danger to the animal patient and their environment. These inexpensive, colored, plastic covers slip over the sharp ends for protection. 50/pk.

- Non-sterile, can be autoclaved
- Length easily trimmable

<b>J0926a</b>	<b>Cover,</b> 1/16" x 3/4".	White.	Fit large "K" Wires.
<b>J0926b</b>	<b>Cover,</b> 5/64" x 3/4".	Blue.	Fit small ESF Pins.
<b>J0926c</b>	<b>Cover,</b> 7/64" x 1".	Green.	Fit medium ESF Pins.
<b>J0926d</b>	<b>Cover,</b> 1/8" x 1".	Red.	Fit large ESF Pins.

*NOTE: Sizes are the outside diameter (o.d.) of pin cover, NOT the pin size.*

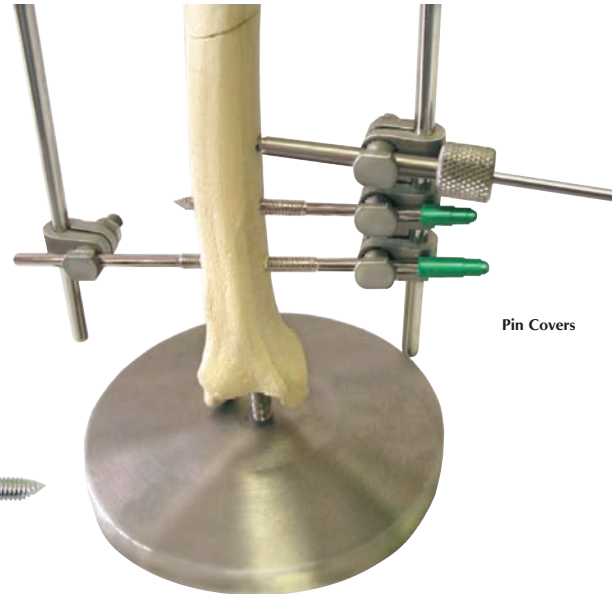

Pin Covers

## Dynamic Fixators

**Uniplanar Dynamic Distractor.** Bone lengthening is occasionally required to substitute bone lost through growth plate abnormalities, e.g. short radius or trauma. The bilateral dynamic fixator is more user friendly than the ring fixator. N.B. 1.00mm pitch means that one full turn of the adjuster moves the assembly 1.00mm. Sliding clamps are available as either single or doubles. When significant bowing of the bone involved has occurred (usually radius) some singles may be necessary.

**Dynamic External Fixator.** New design allows KE device to do limb lengthening on a dynamic basis of 1mm per day. KE pins and threaded rods are the same sizes as standard KE parts. Now in KE plus style allowing use of a wide range of pin diameters.

**External Fixator Kit** contains:

- 2 Threaded rods
- 4 Sliding double KE clamps
- 8 Locking nuts
- 2 Raised-center face pins
- 2 Trocar-trocar pins

**J0371dfm Fixator Kit.** Medium.

**J0371dfs Fixator Kit.** Small.

**Parts. Compatible with system.**

- J0371dLc Sliding Double KE Clamp.** Large.
- J0371dmc Sliding Double KE Clamp.** Medium.
- J0371dms Sliding Single KE Clamp.** Medium.
- J0371dss Sliding Single KE Clamp.** Small
- J0371kaL KE Knurled Adjustor.** Large.
- J0371kam KE Knurled Adjustor.** Medium.
- J0371kas KE Knurled Adjustor.** Small.
- J0371LL KE Locking Nut.** Large.
- J0371Lm KE Locking Nut.** Medium.
- J0371Ls KE Locking Nut.** Small.

**Threaded Rods.**

- J0371tLa Threaded Rod.** Large. 100mm.
- J0371tLb Threaded Rod.** Large. 200mm.
- J0371tma Threaded Rod.** Medium. 75mm.
- J0371tmb Threaded Rod.** Medium. 150mm.
- J0371tmc Threaded Rod.** Medium. 200mm.
- J0371tsa Threaded Rod.** Small. 50mm.
- J0371tsb Threaded Rod.** Small. 100mm.



J0371



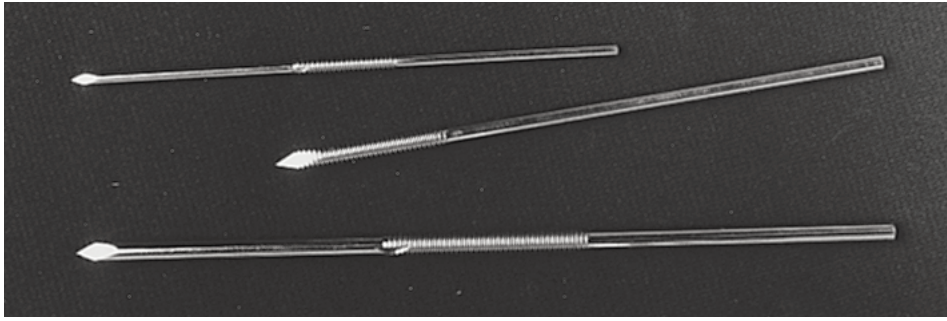

**Positive (Raised) Threaded External Fixation Pins.** Positive or raised thread pins have threads extending above the smooth shaft on a portion of the pin. The positive threaded pins have a tougher pull-out resistance and are the external fixation pins used almost exclusively in human orthopedics.

There are two choices of pin styles and three different sizes.

1. Threaded portion is in mid-shaft
2. Threaded portion is at the end of the pin

All pins are 316LVM implant quality stainless steel.

**Mid-Shaft Positive Threaded Pin.**

	Shaft	Thread	Thread Part	Total	Thread Pitch
<b>J0371a Small.</b>	3/32" dia.	1/8" dia.	3/4"L	4"L	0.9mm
<b>J0371b Medium.</b>	1/8" dia.	5/32" dia.	1 1/4"L	5"L	0.9mm
<b>J0371c Large.</b>	5/32" dia.	3/16" dia.	1 1/2"L	6"L	0.9mm

**Positive Threaded Portion at End of Pin.**

	Shaft	Thread	Thread Part	Total	Thread Pitch
<b>J0371f Small.</b>	3/32" dia.	1/8" dia.	1"L	4"L	0.9mm
<b>J0371g Medium.</b>	1/8" dia.	5/32" dia.	1 1/4"L	4 1/2"L	0.9mm
<b>J0371h Large.</b>	5/32" dia.	3/16" dia.	1 1/2"L	6"L	0.9mm



**Bone Drill Bit.** For pre-drilling positive profile pins. Pre-drill with a bit slightly smaller than the pin shank. (not pictured)

<b>J0372j</b>	<b>Bone Drill Bit.</b>	1.9mm for 2.0mm (5/64")	Positive KE X-small pins.
<b>J0372k</b>	<b>Bone Drill Bit.</b>	2.3mm for 2.4mm (3/32")	Positive KE small pins.
<b>J0372l</b>	<b>Bone Drill Bit.</b>	3.0mm for 3.2mm (1/8")	Positive KE medium pins.
<b>J0372n</b>	<b>Bone Drill Bit.</b>	3.8mm for 4.0mm (5/32")	Positive KE large pins.

**J0371tp KE Tissue Protector.** Soft tissue protection is extremely important during the insertion of KE bone pins. Without soft tissue protection there is a tendency for soft tissue structures such as muscle, blood vessels, and nerves to be wrapped around the pin. This tendency is greatly increased with the use of raised threaded pins or drill bits. Other drill guides and tissue protectors will work when placing free standing pins. However when placing pins in the middle of a KE frame, they can not be used. 7"L.

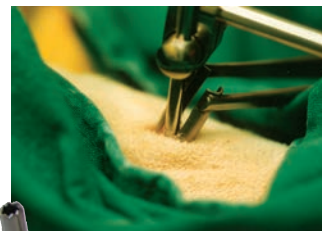

**J0371tp**

**Fessa Tubular Fixator System.** This system is widely used in Europe and offers several advantages over conventional fixator systems. The connecting tubes or rods use a simple hexhead set screw as the pin holding or clamping mechanism. The system is very strong for its light weight. The smaller tubes will accept the smallest of K-wire making it extremely useful in fracture management of small exotics and cats.

- Available in 6, and 8mm diameter tubes.
- 6mm tubes accepts pins of varying diameter 0.9mm (0.035") to 1.8mm ( 1/16")
- 8mm tube accepts pins of 1.6mm ( 1/16") to 3.2 (1/8")
- Design allows a placement of multiple pins close together in small fragments
- Pins can be placed at an angle to tube or straight through adjacent holes. Pins are locked into position by simple hexhead locking screws tightened by an Allen wrench
- Tubes are concentric and will slide inside each other to create hybrid frame of variable lengths. This is useful where distal pins are required to be much smaller in diameter
- Lockable hinges link tubes at any pre-set angle desired

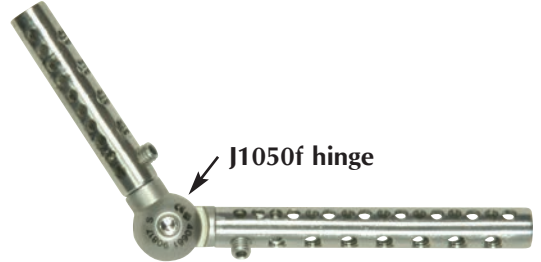
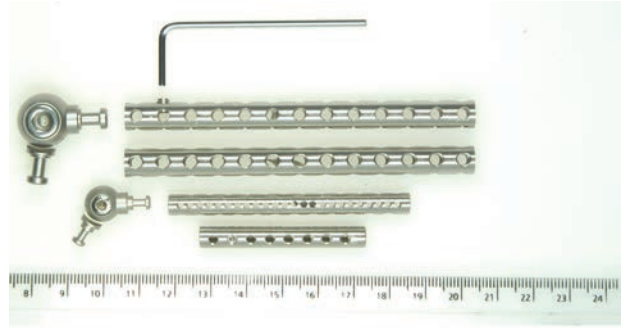

J1050	6/8mm starter kit	individual ordering code
	6mmX 30mm long tube	(J1050A)
	6mmX 45mm long tube	(J1050B)
	6mmX 65mm long tube	(J1050C)
	8mmX 100mm tube	(J1051A)
	8mmX 150mm tube	(J1051B)
	8mmX 200mm I tube	(J1051C)
	hexdriver Allen wrench - 6mm	(J1050D)
	locking screws (10) - 6mm	(J1050E)
	hexdriver Allen wrench - 8mm	(J1051D)
	locking screws (10)- 8mm	(J1051E)
	K wires (6) 0.035 x 7"	(J250M)
	K wires (6) 0.062 x 7"	(J250P)
	Bone pin part threaded 1/8" (3)	(J251E)
	Bone pin part threaded 3/32" (3)	(J251C)

**Options:**

<b>J1050f</b>	<b>6mm hinge</b>
<b>J1051f</b>	<b>8mm hinge</b>

**Titanium FESSA.** The tubular structure acts as both clamp and bar. Birds, small furries, and exotics demand even lighter constructs. Using a titanium tube of 5.0mm in diameter enables the surgeon to apply FESSA constructs weighing from as little as 1.5 grams. Suitable for pins 0.8mm to 1.6mm. Includes 6 set screws.

<b>J1050at</b>	<b>5mm x 30mm Titanium FESSA</b>
<b>J1050bt</b>	<b>5mm x 45mm Titanium FESSA</b>

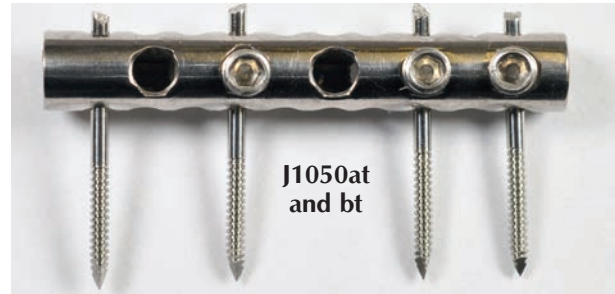

**J0343 Starter Kit. Cannulated infusion Screw with Insertion Key in Stainless Steel case.** Where infection has penetrated and lodged in the medullary cavity of bone in the distal limb or equine maxillary sinus. It may be necessary to infuse antibiotics directly to achieve therapeutic levels where they are needed.

- Kit includes: J0409e** Cortical tap 4.5mm.
- **J0372e** Drill bit 1/8".
  - **J0343a** Cannulated infusion screw.
  - Stainless steel case and insertion key.

Screws only:

<b>J0343a</b>	<b>18mm cannulated screw.</b>
<b>J0343c</b>	<b>40mm cannulated screw.</b>
<b>J0343d</b>	<b>70mm cannulated screw.</b>



**CANNULATED INFUSION SCREW**



**J0158 Leighton Bone Pin Introducer** is designed to help reduce overriding fractures and facilitate insertion of the intramedullary pin into the distal segment of a fracture (see illustration for explanation of use).

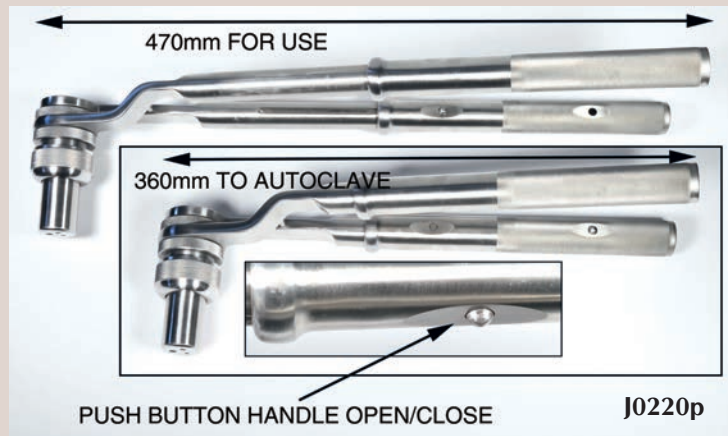
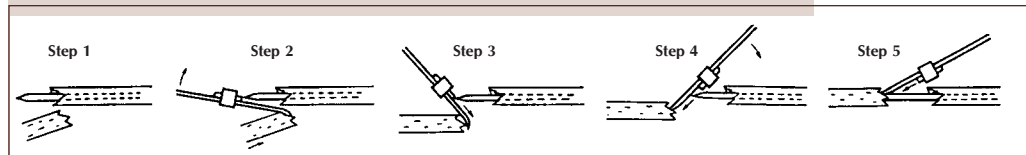

**J0220p Enclosed Bone Pin Cutter.** Completely cuts a bone pin up to 4mm ( $5/32$ ""). Addresses the problems created by open end standard pin cutters. The enclosed shearing action of the pin cutter:

- Eliminates the potentially dangerous flying pin end.
- Removes sharp point that can irritate soft tissue or cut the patient or people coming into contact.
- Eliminates the slightly deformed pin end that could jam the KE clamps.

Extending handles means that cutters are very powerful yet fit in small autoclaves.

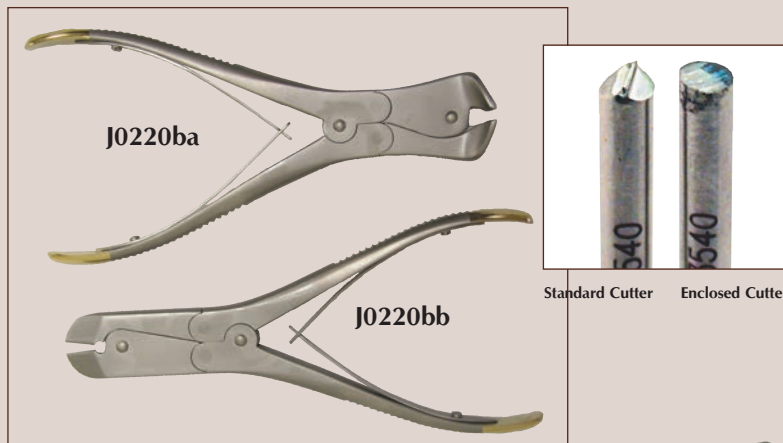

**J0220ba K-Wire End Cutter** with tungsten carbide inserts. Cuts wire up to 2.5mm.  $8\frac{1}{2}$ "L.

**J0220bb K-Wire Side Cutter** with tungsten carbide inserts. Cuts wire up to 2.2mm. 9"L.



**J0220 Pin Cutters.** For cutting intramedullary pins and customizing bone plates. Stainless steel. 1470g. 48cm (19"L). Please note: will not cut  $1/4$ " pins.

- Cuts up to 6.4mm ( $1/4$ "") pins
- Narrow jaws allow extra-close pin cutting



**J0220q Large pin cutter** similar to J-220 only handles detach to fit into smaller autoclaves. From 490mm (19  $3/8$ "") to 260mm (10  $3/8$ ""). Gold colored handles with tungsten carbide inserts. Please note: will not cut  $1/4$ " pins.



**J0220x Pin cutter to max 4.0mm.** Cutter with TC inserts which cuts pins and wires up to a maximum of 4.0mm/ $5/32$ ". At 37cm/14.5" long it fits most autoclaves. It is the ideal cutter for ESF pins. Please note: will not cut  $1/4$ " pins.



**J1066 Lesser wire passer/retriever.** The Lesser wire passer/retriever was designed and developed by Arnold Lesser VMD to assist the surgeon in the placement of wire or nylon sutures. The instrument performs a number of functions:

- Locates the drill bit on the bone surface, eliminating “drill skate”.
- Protects the soft tissues, preventing them from wrapping around the drill bit.
- Eases the passage of the suture through the hole.
- Retrieves the suture material from the blind side as the forceps are removed.
- Suitable for drill bit sizes up to 2.5mm and wire up to 18gauge.
- Suitable for bones up to 15mm in thickness.

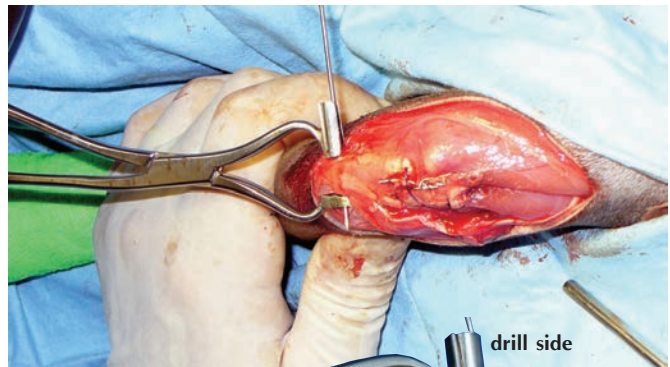

**J1066a Lesser wire passer/retriever.** Large size for bones up to 25mm (1") diameter. Go to [www.jorvet.com](http://www.jorvet.com) for a short video.

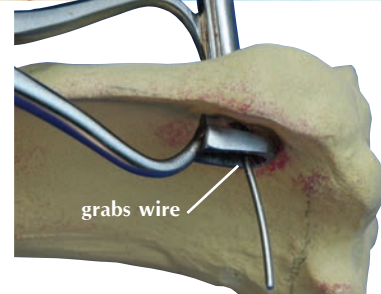

**J0049c Wire Cutter** with notched cutout. Stainless steel. Also useful for cutting suture wire.

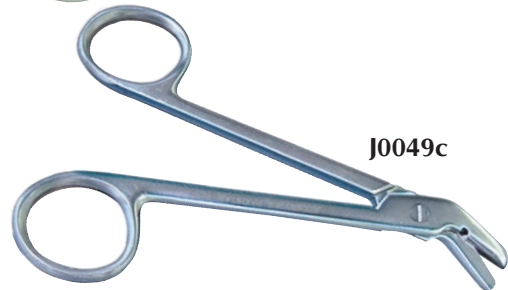

**J0217 Cerclage Wire Passer.** This is a simple instrument for passage of cerclage wire around fracture sites. Stainless steel. 15cm.

- Minimizes trauma to surrounding tissue
- Saves surgical time
- Double-ended for a whole range of bone sizes.



**J0221 Sismey's Cerclage Wire Passer.** Has three interchangeable hollow needles for different-sized bones.

**Strong Cerclage Wire Passers.** To even the most experienced of surgeons, passing good cerclage wires can be a bit of a challenge. Most cerclage passers are of deep profile making them difficult to pass between bones which may be in close approximation such as those of the lower limbs. Most are also poor for manipulating fragments. This device sets out to address these shortcomings. Another feature of the new passer is that the instrument may be left in situ during tightening, minimizing migration and oblique wires.

The low profile of these devices aims to allow easier passage between bones. Having an open channel and with wire passable from the tip of handle end should simplify function. The flat on the internal aspect of the tip aims to give better feel for use as a reduction aid and to assist with close passage of the device around the bone. Available as a three instrument set, each device is double ended giving internal diameters of 12.5mm and 15mm on the smallest instrument, 20mm and 25mm on the medium instrument and 30mm and 40mm on the largest instrument.



**J1214a Strong Cerclage Wire Passer Small** (D/E: i/d 12.5mm/15mm.

**J1214b Strong Cerclage Wire Passer Medium** (D/E: i/d 20mm/25mm.

**J1214c Strong Cerclage Wire Passer Large** (D/E: i/d 30mm/40mm.

**J1214s Strong Cerclage Wire Passer, set of 3**

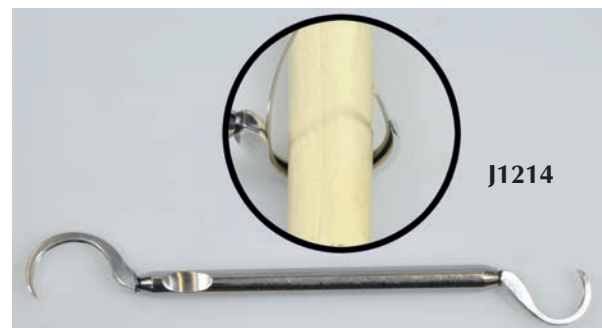

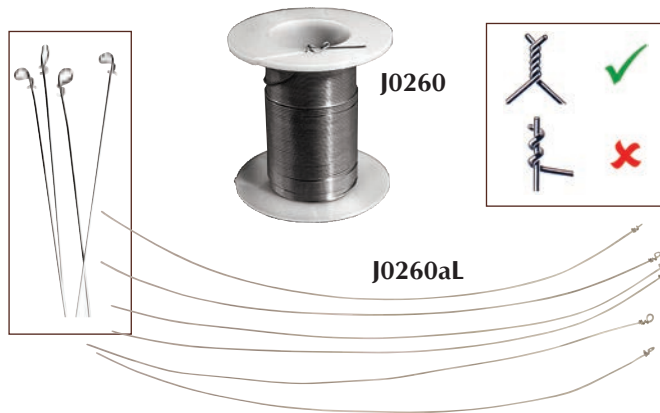

**Cerclage Wire.** Fine quality cerclage wire on autoclavable nylon spools.

<b>J0260a</b>	<b>Cerclage Wire.</b>	1.25mm	18g x 10m.
<b>J0260b</b>	<b>Cerclage Wire.</b>	1.0mm	20g x 10m.
<b>J0260c</b>	<b>Cerclage Wire.</b>	0.7mm	22g x 10m.
<b>J0260d</b>	<b>Cerclage Wire.</b>	0.5mm	24g x 10m.
<b>J0260e</b>	<b>Cerclage Wire.</b>	0.45mm	26g x 10m.
<b>J0260f</b>	<b>Cerclage Wire.</b>	0.35mm	28g x 10m.

**Loop Cerclage Wire** with pre-formed eyelet. 6/pk.

<b>J0260aL</b>	<b>Loop Cerclage Wire.</b>	18g x 12".
<b>J0260bL</b>	<b>Loop Cerclage Wire.</b>	20g x 12".
<b>J0260cL</b>	<b>Loop Cerclage Wire.</b>	22g x 12".

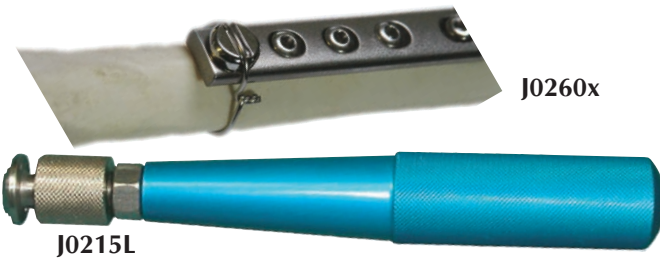

**J0260x** **Cerclage Button.** The cerclage button occupies a screw hole. The slot retains cerclage wire where screw placement is not possible. Fits 3.5mm DCP holes.

**J0215L** **Large Cerclage Wire Twister.** Will work with any size wire. For cerclage, hemicerclage or tension band wiring. Stainless steel. 7"L.

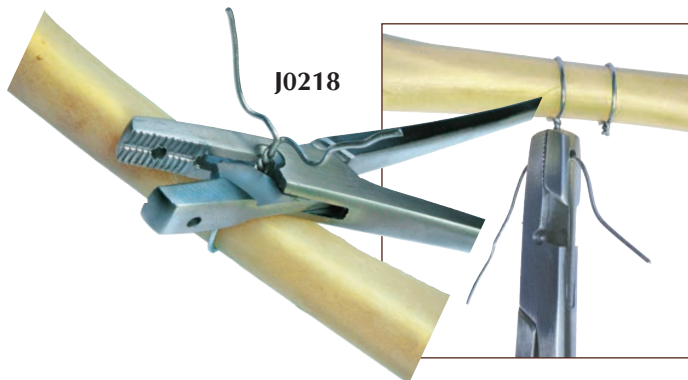

**J0218** **Wire Twister/Shear Cutter.** Stainless steel. 15cm.

- Holds and twists all gauges of orthopedic wire
- Cuts wire up to 18g (1.25mm)/twisted double
- Ratchet locks jaws onto wire
- Cutter has shear action for long life
- Small hole in jaws threads wire for secure grip



**J0218L** **Cerclage Wire Tightener** for Loop-Style Cerclage Wire. Velvet finish. German-made. 5".



**J0218LD** **Cerclage wire tightener** with two tightening knobs for double loop eyed wire.

- Fiber handle
1. Use single tightener for single wire
  2. Use both tighteners for double loops



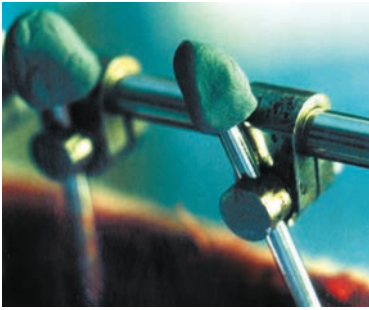

Protection of Cut Ends of Pins

**Epoxy ESF Putty.** This putty offers a quick and simple alternative to standard bar and clamp systems. The putty, once mixed, stiffens in five minutes and within one hour is fully cured. The putty comes in a round protective resealable 3/4" dia. tube. The amount required can be clipped off just like cookie dough. It has a pre-measured catalyst that is activated upon kneading or mixing.

- Features:
- No liquid and powder mixing required
  - No odor
  - Immediately very moldable to shape
  - Inexpensive compared to clamps/bars
- Applications:
- Different size pin placed at varying angles
  - ESF in very small animals (i.e., guinea pig)
  - Fractures of the mandible
  - Protecting sharp ends of cut pins
  - Joining non-standard pins and bars

**J0751 Epoxy ESF Putty.** 55g tube  
**J0751a Epoxy ESF Putty.** 110g tube.

J0751

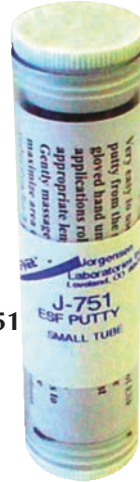

**Bone Cement.** Bone cement is a sterile form of Polymethyl Methacrylate (PMMA) originally formulated for use in hip replacement. It is available with or without antibiotics and a range of viscosities. In addition to hip replacement bone cement, veterinarians have found a wide range of other applications.

There are two types that offer different viscosities for different applications. All consist of liquid/powder portions that are mixed together.

Now includes sterile mixing bowls with spatula. This makes the process much easier with better odor control.

**Type 1: Medium Viscosity** forms a digitally (finger) malleable putty.

- Applications:
- Cement the acetabular component of a hip replacement
  - Adjunct to acetabular fracture with pins and screws
  - Spinal fractures
  - Management of cervical wobblers by distraction fusion
  - Filling dead space in equine tooth extractions
  - Manufacturing of antibiotic impregnated beads (AIPMMA)
  - Choose to add one's choice of suitable antibiotic or pre-added gentamycin, creating a slow release focal antibiosis. Especially useful in the management of refractory rabbit abscesses. Instructions included.

**J0912a Medium Viscosity Cement.** 20gm.  
**J0912ga Medium Viscosity Cement.** 20gm with 1gm Gentamycin.

**Type II: Low Viscosity** when mixed is suitable for use through a syringe with a large catheter tip.

- Applications:
- Cementing the femoral prosthesis

**J0913a Low Viscosity Cement.** 20gm.  
**J0913ga Low Viscosity Cement.** 20gm with 1gm of Gentamycin



J0913



Stabilization of Opening Wedge Osteotomy



Stabilization of Bilateral Mandibular Fracture



Stabilization of Medial Shearing Injury Hock



Fractured Tibia In a Cat



Fractured Tibia in a Guinea Pig



Tarso-Metatarsal Arthrodesis



**Technovit:** A powder and liquid that when mixed together form a hard acrylic.

Methyl methacrylate compound is getting widespread use in veterinary medicine in a number of different applications. These forms require smaller, more specialized packaging than the standard hoof applications.

Two relatively new uses include:

1. Acrylic in place of a connecting bar in the use of an external fixator. The acrylic can be shaped to follow body contours. An additional requirement is a tube-shaped container for holding the acrylic's shape while it cures.
2. A second use is in mixing an antibiotic powder together with the acrylic powder portion. Then the liquid portion is mixed in. The resulting mixture is shaped into very small beads that can be strung together like a string of pearls. The beads can be inserted into certain types of refractory wounds or abscesses. The bead acts as a time-release capsule for the antibiotic. The antibiotic leeches out directly into the infection site. The acrylic remains inert and is removed at a later date. (See *bone cement* page 182)

The product is packaged in a heavy-duty 3ml sealed bag. The powder and liquid are separated by a plastic removable divider.

- J0860** 30ml Liquid Pouch/50gm Powder.
- J0860a** 60ml Liquid Pouch/100gm Powder.
- J0860b** 120ml Liquid Pouch/200gm Powder.

For external fixation use:

- J0861** **Single Tube Configuration Kit.** Includes:
  - 60ml liquid pouch/100gm powder
  - 8" section of plastic hollow tube, 22mm
  - 2 plastic caps
  - Instructions for use
- J0861a** **Small Single Tube Configuration Kit.** Includes:
  - 30ml liquid pouch/50gm powder
  - 6" section of plastic hollow tube, 15mm
  - 2 plastic caps
  - Instructions for use
- J0862** **Two-Tube Configuration Kit.** Includes:
  - 120ml liquid pouch/200gm powder
  - 18" section of plastic hollow tube, 22mm
  - 4 plastic caps
  - Instructions for use
- J-862a** **Small Two-Tube Configuration Kit.** Includes:
  - 60ml liquid pouch/100gm powder
  - 18" section of plastic hollow tube, 15mm
  - 4 plastic caps
  - Instructions for use

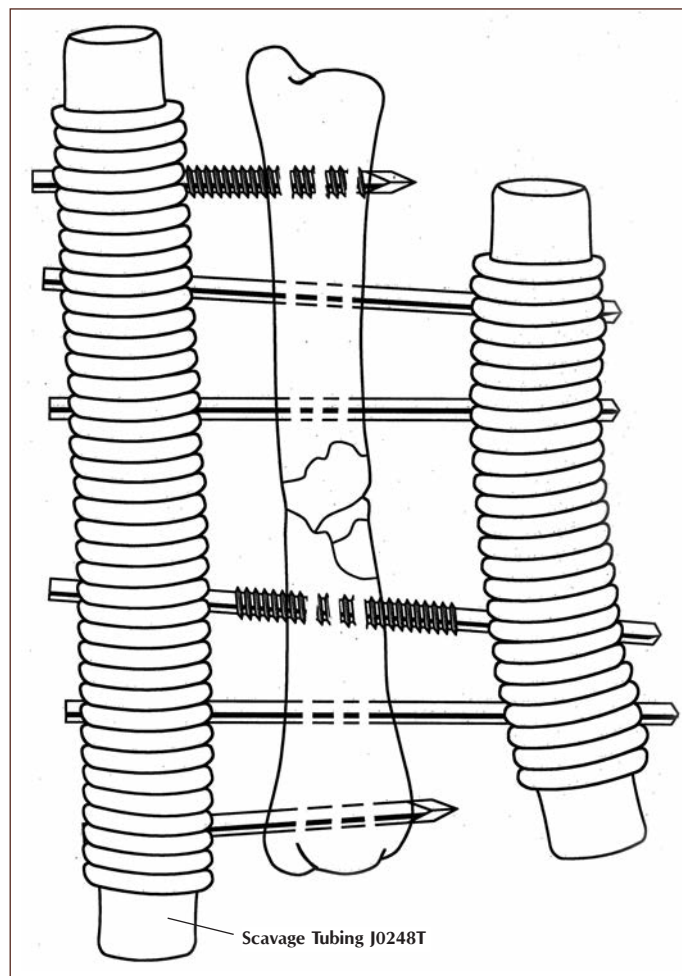
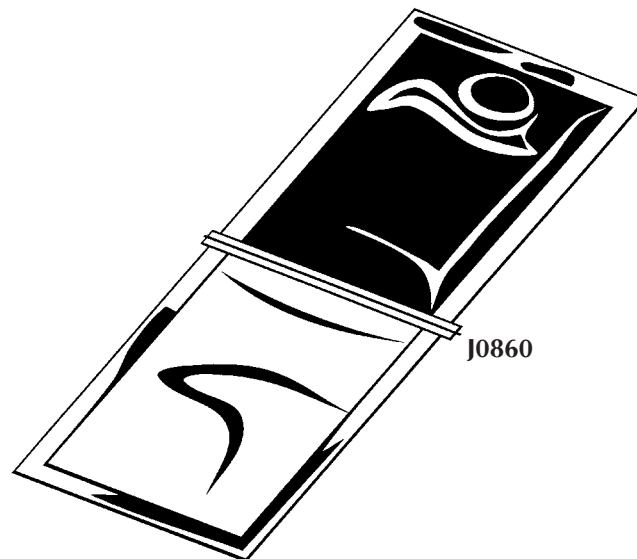

**Implants-Bone Plating and Screws.** JorVet introduces a very comprehensive line of plating equipment for the veterinarian. For many years, veterinary orthopedics has been complicated by the use of two incompatible plating systems: The Synthes (AO) use of cortical screws with compression plates versus self-tapping (Sherman) or round-hole plates. The two systems differed both in design and metallurgy. All JorVet implants are now made from stainless steel to the latest human specifications, exceeding DIN, 7443 and ISO 5832/1 standards. It is now safe to use implants from a variety of sources, provided they meet the above specifications. Standard round-hole plate may be used with cortical screws or self-tapping screws. Only cortical or cancellous screws can be used with compression plates through pre-drilled pilot holes.

*NOTE: Listings are in metric sizes, but for reference:  $7/64'' = 2.7\text{mm}$  and  $9/64'' = 3.5\text{mm}$ .*

J0372d



**Orthopedic Drill Bit.** JorVet drill bits are European-made. Razor sharp. Stainless steel. 5".

<b>J0372a</b>	<b>Bit.</b>	$1/16''$	1.6mm
<b>J0372b</b>	<b>Bit.</b>	$5/64''$	2.0mm
<b>J0372c</b>	<b>Bit.</b>	$3/32''$	2.4mm
<b>J0372d</b>	<b>Bit.</b>	$7/64''$	2.7mm
<b>J0372e</b>	<b>Bit.</b>	$1/8''$	3.2mm
<b>J0372f</b>	<b>Bit.</b>	$9/64''$	3.5mm
<b>J0372g</b>	<b>Bit.</b>	$5/32''$	4.0mm
<b>J0372h</b>	<b>Bit.</b>	$11/64''$	4.5mm
<b>J0372i</b>	<b>Bit.</b>	$1/4''$	6.4mm

J0372x series  
Antiskid drill bits



**Antiskid Drill Bits.** These drill bits have a sharp needle point tip that penetrates the bone for easier drilling. It helps avoid skipping over the bone especially if drilling at an angle other than 90°. Made from hard 420 stainless steel.

<b>J0372ax</b>	<b>Bit.</b>	$1/16''$	1.5mm	length 6cm
<b>J0372bx</b>	<b>Bit.</b>	$5/64''$	2.0mm	length 10cm
<b>J0372cx</b>	<b>Bit.</b>	$3/32''$	2.5mm	length 11.5cm
<b>J0372dx</b>	<b>Bit.</b>	$7/64''$	2.7mm	length 13cm
<b>J0372ex</b>	<b>Bit.</b>	$1/8''$	3.2mm	length 13cm
<b>J0372fx</b>	<b>Bit.</b>	$9/64''$	3.5mm	length 13cm
<b>J0372fxL</b>	<b>Bit.</b>	$9/64''$	3.5mm	length 18cm
<b>J0372gx</b>	<b>Bit.</b>	$5/32''$	4.5mm	length 13cm

**J0372cz 2.5mm drill bit.** (not pictured) Length 6" or 11.5cm.

- Standard razor tip
- Gold titanium nitride coating finish
- Will out-last and out-perform any standard drill bit

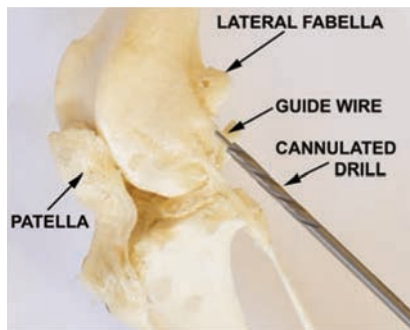

**Cannulated Drills.** For maximum control over the alignment of bone tunnels use of cannulated drills is preferred. A fine guide wire is drilled through where the bone tunnel or screw hole is required. Only when the surgeon is satisfied that the guide wire is correctly positioned is the drill driven along the wire to create the hole. The guide wire can be repositioned if necessary without causing undue trauma to the site.

<b>J0372cna</b>	2.5mm	130mm long	1.1mm cannulation
<b>J0372cnb</b>	2.7mm	130mm long	1.1mm cannulation
<b>J0372cnc</b>	3.5mm	130mm long	1.1mm cannulation

**J0250n** Guide Wire 1.1mm x 7" (pack of 6)



J0372dk

**J0372dk Drill Stop Kit.** Drilling to a pre-measured depth can be a challenge even with a 'C' arm! A more reasonably priced option is to use a drill stop which is tightened onto the drill bit at the required depth. The set includes 4 different size stops to cover all the standard drill sizes: 2.0, 2.5, 2.7, 3.2, 3.5 & 4.5mm. The stop is tightened onto the drill bit using the hex driver provided.

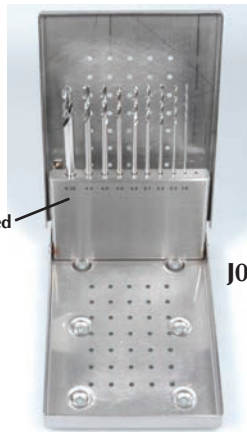

drill sizes are labeled

J0372xc

**J0372x Orthopedic Drill Case.** This folding box can hold 10 standard size drill bits. Autoclavable. Measures 5 1/2" x 4" x 3/4". Stainless steel. (Bits not included.)

**J0372xc Drill Case** with 9 different standard drill bits (J-372A-I).

**J0430 Sherman Self-Tapping Plate System, 3.5mm and 2.7mm**

1 x J0372c	<b>Drill Bit.</b>	3/32", 2.4mm	
1 x J0372d	<b>Drill Bit.</b>	7/64", 2.7mm	
1 x J0372f	<b>Drill Bit.</b>	9/64", 3.5mm	
1 x J0414	<b>Small Drill Guide.</b>	3.5mm i.d.	
1 x J0414b	<b>Insert Sleeve</b>	3.5/2.7mm	
1 x J0401c	<b>Screwdriver</b> only for	2.7mm Flat head	
1 x J0401e	<b>Screwdriver</b> only for	3.5mm Cruciate head	
1 x J0853a	<b>Bone Plate Benders.</b>		
1 x J0410	<b>Depth Gauge.</b>		
1 x J0430d	<b>Self-Tapping Plating Case with 2.7/3.5mm screw rack</b>		
	<b>Plates (9).</b>		
1 x J0405c	<b>2.7mm Round Hole Plate.</b>	4 holes x 27mm	
1 x J0405e	<b>2.7mm Round Hole Plate.</b>	5 holes x 33mm	
1 x J0405g	<b>2.7mm Round Hole Plate.</b>	6 holes x 39mm	
1 x J0407d	<b>3.5mm Round Hole Plate.</b>	5 holes x 58mm	
1 x J0407f	<b>3.5mm Round Hole Plate.</b>	6 holes x 76mm	
1 x J0407g	<b>3.5mm Round Hole Plate.</b>	7 holes x 82mm	
	<b>Screws (90).</b>		
1 x J0406c	<b>3.5mm Self-Tapping Screw.</b>	6/pk. 16mm L	
1 x J0406d	<b>3.5mm Self-Tapping Screw.</b>	6/pk. 19mm L	
1 x J0406e	<b>3.5mm Self-Tapping Screw.</b>	6/pk. 22mm L	
1 x J0406f	<b>3.5mm Self-Tapping Screw.</b>	6/pk. 25mm L	
1 x J0406g	<b>3.5mm Self-Tapping Screw.</b>	6/pk. 28mm L	
1 x J0406h	<b>3.5mm Self-Tapping Screw.</b>	6/pk. 31mm L	
1 x J0406i	<b>3.5mm Self-Tapping Screw.</b>	6/pk. 34mm L	
1 x J0406j	<b>3.5mm Self-Tapping Screw.</b>	6/pk. 38mm L	
1 x J0406k	<b>3.5mm Self-Tapping Screw.</b>	6/pk. 41mm L	
1 x J0406l	<b>3.5mm Self-Tapping Screw.</b>	6/pk. 44mm L	
1 x J0404a	<b>2.7mm Self-Tapping Screw.</b>	6/pk. 10mm L	
1 x J0404b	<b>2.7mm Self-Tapping Screw.</b>	6/pk. 13mm L	
1 x J0404c	<b>2.7mm Self-Tapping Screw.</b>	6/pk. 16mm L	
1 x J0404d	<b>2.7mm Self-Tapping Screw.</b>	6/pk. 19mm L	
1 x J0404e	<b>2.7mm Self-Tapping Screw.</b>	6/pk. 22mm L	

**Heavy-Duty Round-Hole.**

<b>J0408a</b>	8 holes x 104mm
<b>J0408b</b>	9 holes x 117mm
<b>J0408c</b>	10 holes x 130mm



**J0430s - 2mm Sherman Self-Tapping System**

<b>J0430s</b>	<b>2mm Sherman Self-Tapping Screw Kit.</b>
<b>J0401a</b>	<b>Screwdriver</b> for 2.0mm self-tapping screws.
<b>J0372a</b>	<b>Pilot Drill Bit.</b> 1.6mm.
<b>J0372b</b>	<b>Drill Bit.</b> 2.0mm.
<b>J0415a</b>	<b>Sleeve for 2.0mm bit.</b> For soft tissue protection.
<b>J0430cs</b>	<b>Stainless Steel Case</b> with screw rack.
<b>J0410a</b>	<b>Depth Gauge</b>



**Bone Screws:** packages of 6

<b>J0402a</b>	6mm
<b>J0402b</b>	8mm
<b>J0402c</b>	10mm
<b>J0402d</b>	12mm

**2.0mm Bone Plate.** Round holes.

<b>J0403c</b>	<b>Bone Plate.</b> 4-hole	23mm L.
<b>J0403e</b>	<b>Bone Plate.</b> 5-hole	28mm L.
<b>J0403g</b>	<b>Bone Plate.</b> 6-hole	33mm L.



**Screwdriver.**

- J0401a** **Screwdriver.** Only for 2.0mm screw. Flat head. With sleeve.
- J0401b** **Sleeve.** Only for 2.0mm screw.
- J0401c** **Screwdriver.** Only for 2.7mm screw. Flat head. With sleeve.
- J0401d** **Sleeve.** Only for 2.7mm screw.
- J0401e** **Screwdriver.** For 3.5mm screw. Cruciate head. Without sleeve.



**J0401 - 2mm Sherman Self-Tapping System**



**2mm Sherman Self-Tapping System.** The 2mm self-tapping system enables the veterinary surgeon to plate the bones of cats and miniature dogs effectively without prohibitive cost. The range includes "T" plates, reconstruction plates and a wide range of standard-size plates.

- J0401a** **Screwdriver** for 2.0mm screws.
- J0401b** **Sleeve** for 2.0mm screws.
- J0372a** **Pilot drill.** 1.6mm.
- J0372b** **Clearance drill.** 2.0mm.
- 2mm Screw.** See subsequent listings.

**2mm Self-Tapping Screw.** Used in conjunction with our 2mm bone plates, 2mm self-tapping screws allow the veterinary surgeon to plate the long bones of small patients or the small bones of larger patients. Until now this has been possible only with sophisticated equipment. 6/pk.

- |               |                       |               |                       |
|---------------|-----------------------|---------------|-----------------------|
| <b>J0402a</b> | <b>Screw.</b> 6mm L.  | <b>J0402e</b> | <b>Screw.</b> 14mm L. |
| <b>J0402b</b> | <b>Screw.</b> 8mm L.  | <b>J0402f</b> | <b>Screw.</b> 16mm L. |
| <b>J0402c</b> | <b>Screw.</b> 10mm L. | <b>J0402g</b> | <b>Screw.</b> 18mm L. |
| <b>J0402d</b> | <b>Screw.</b> 12mm L. | <b>J0402h</b> | <b>Screw.</b> 20mm L. |

**J0402**

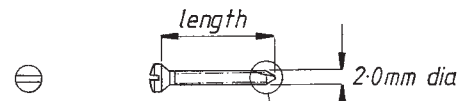

*DRILL DATA*  
 pilot 1.6 dia  
 clearance 2.0 dia

**J0403**

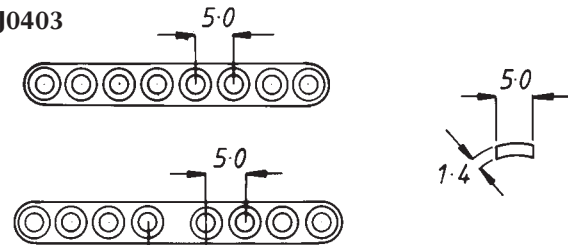

*RECOMMENDED SCREW 2.0mm dia SELF TAPPING 2.0dia CORTICAL*

**2.0mm Bone Plate,** round holes. Available in a wide range of sizes, the 2mm plates used with either 2mm self-tapping screws or 2mm cortical screws provide for the secure repair of the small bones of a dog or cat.

- |               |                           |         |
|---------------|---------------------------|---------|
| <b>J0403a</b> | <b>Bone Plate.</b> 2-hole | 13mm L. |
| <b>J0403b</b> | <b>Bone Plate.</b> 4-hole | 20mm L. |
| <b>J0403c</b> | <b>Bone Plate.</b> 4-hole | 23mm L. |
| <b>J0403d</b> | <b>Bone Plate.</b> 5-hole | 25mm L. |
| <b>J0403e</b> | <b>Bone Plate.</b> 5-hole | 28mm L. |
| <b>J0403f</b> | <b>Bone Plate.</b> 6-hole | 30mm L. |
| <b>J0403g</b> | <b>Bone Plate.</b> 6-hole | 33mm L. |
| <b>J0403h</b> | <b>Bone Plate.</b> 7-hole | 35mm L. |
| <b>J0403i</b> | <b>Bone Plate.</b> 7-hole | 38mm L. |
| <b>J0403j</b> | <b>Bone Plate.</b> 8-hole | 40mm L. |
| <b>J0403k</b> | <b>Bone Plate.</b> 8-hole | 43mm L. |

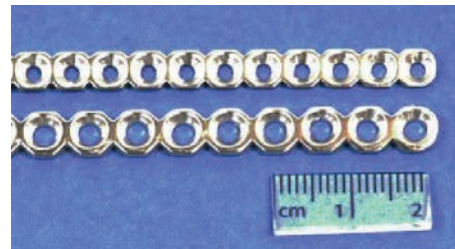

- J0374b** **2mm Reconstruction Plate.** 30-hole, 150mm L.

*NOTE: See page 218 for more malleable or cuttable plates.*

- J1145** **Screw Holding Forceps.** A very useful instrument for selecting screws with minimal handling. Can be used with any style and size of screw. Helps avoid dropping an important screw intra operatively!



**J1145**





**2.7mm (7/64") Sherman Self-Tapping System.** This system of screws and plates utilizes the familiar 7/64" self-tapping screw. Until now the available bone plates for this screw were extremely limited. The plates were too weak with too few holes. A wide range of plates is now available, including "T" plates and reconstruction plates.

- J0401c Flathead Screwdriver.** Includes sleeve.
- J0401d Sleeve** only for above flathead screwdriver.
- J0372c 2.4mm Pilot Hole Drill Bit.**
- J0372d 2.7mm Clearance Hole Drill Bit.**

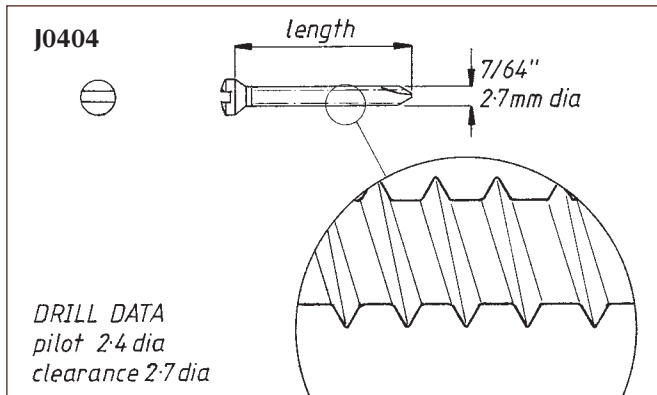

**J0404**  
*DRILL DATA*  
 pilot 2.4 dia  
 clearance 2.7 dia

**2.7mm (7/64") Self-Tapping Screw.** For use with 2.7mm (7/64") round-hole plates in small- to medium-sized patients. 6/pk.

- |                              |                              |
|------------------------------|------------------------------|
| <b>J0404a Screw.</b> 10mm L. | <b>J0404h Screw.</b> 31mm L. |
| <b>J0404b Screw.</b> 13mm L. | <b>J0404i Screw.</b> 34mm L. |
| <b>J0404c Screw.</b> 16mm L. | <b>J0404j Screw.</b> 38mm L. |
| <b>J0404d Screw.</b> 19mm L. | <b>J0404k Screw.</b> 41mm L. |
| <b>J0404e Screw.</b> 22mm L. | <b>J0404l Screw.</b> 44mm L. |
| <b>J0404f Screw.</b> 25mm L. | <b>J0404m Screw.</b> 48mm L. |
| <b>J0404g Screw.</b> 28mm L. | <b>J0404n Screw.</b> 50mm L. |
|                              | <b>J0404o Screw.</b> 57mm L. |

**2.7mm Round-Hole Plate.** 6mm W x 2mm thick bone plates for 2.7mm (7/64") screws. The 2.7mm round-hole plate has holes at 6mm intervals, and comes in a range of lengths.

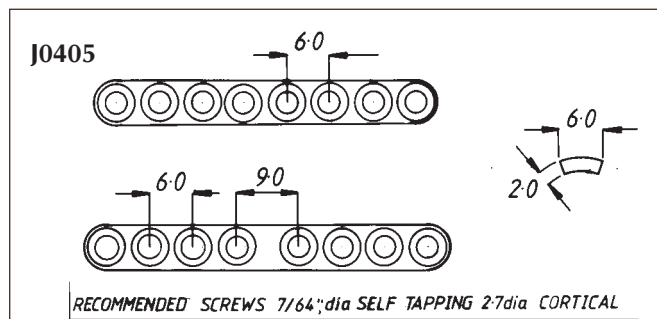

- |                             |         |
|-----------------------------|---------|
| <b>J0405a Plate.</b> 2-hole | 15mm L. |
| <b>J0405b Plate.</b> 4-hole | 24mm L. |
| <b>J0405c Plate.</b> 4-hole | 27mm L. |
| <b>J0405d Plate.</b> 5-hole | 30mm L. |
| <b>J0405e Plate.</b> 5-hole | 33mm L. |
| <b>J0405f Plate.</b> 6-hole | 36mm L. |
| <b>J0405g Plate.</b> 6-hole | 39mm L. |
| <b>J0405h Plate.</b> 7-hole | 42mm L. |
| <b>J0405i Plate.</b> 7-hole | 45mm L. |
| <b>J0405j Plate.</b> 8-hole | 48mm L. |
| <b>J0405k Plate.</b> 8-hole | 51mm L. |

- J0374a 2.7 (7/64") Reconstruction Plate.**  
24-hole 150mm L.

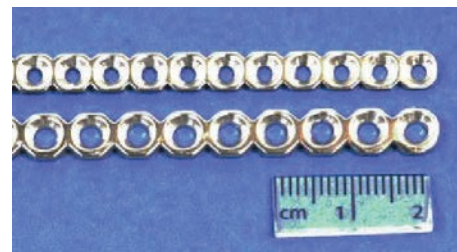

*NOTE: See page 218 for more malleable or cuttable plates.*



**3.5mm (<sup>9</sup>/<sub>64</sub>" ) Sherman Self-Tapping Screw.** The <sup>9</sup>/<sub>64</sub>" self-tapping screw has similar pull-out resistance to 3.5mm cortical screws. The main problem with this screw has been a lack of suitable bone plates. Our new range of 3.5mm round-hole plates considerably widens the scope of these self-tapping screws. Cruciate head. 6/pk.

<b>J0406a</b>	10mm L.	<b>J0406f</b>	25mm L.	<b>J0406k</b>	41mm L.
<b>J0406b</b>	13mm L.	<b>J0406g</b>	28mm L.	<b>J0406l</b>	44mm L.
<b>J0406c</b>	16mm L.	<b>J0406h</b>	31mm L.	<b>J0406m</b>	48mm L.
<b>J0406d</b>	19mm L.	<b>J0406i</b>	34mm L.	<b>J0406n</b>	50mm L.
<b>J0406e</b>	22mm L.	<b>J0406j</b>	38mm L.	<b>J0406o</b>	57mm L.

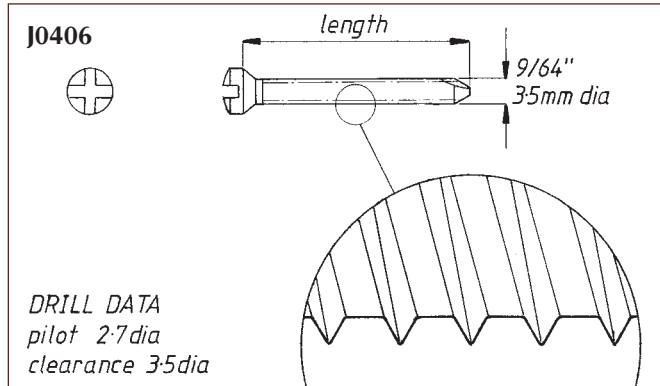

**3.5mm Standard Round-Hole Plate.** A stronger and less expensive alternative to 3.5mm compression plates. Material is compatible with your choice of cortical or self-tapping screws.

<b>J0407a</b>	<b>Plate.</b> 2-hole	22mm L.
<b>J0407b</b>	<b>Plate.</b> 4-hole	46mm L.
<b>J0407c</b>	<b>Plate.</b> 4-hole	52mm L.
<b>J0407d</b>	<b>Plate.</b> 5-hole	58mm L.
<b>J0407e</b>	<b>Plate.</b> 6-hole	70mm L.
<b>J0407f</b>	<b>Plate.</b> 6-hole	76mm L.
<b>J0407g</b>	<b>Plate.</b> 7-hole	82mm L.
<b>J0407h</b>	<b>Plate.</b> 7-hole	88mm L.
<b>J0407i</b>	<b>Plate.</b> 8-hole	94mm L.
<b>J0407j</b>	<b>Plate.</b> 8-hole	100mm L.
<b>J0407k</b>	<b>Plate.</b> 9-hole	106mm L.
<b>J0407l</b>	<b>Plate.</b> 9-hole	118mm L.
<b>J0407m</b>	<b>Plate.</b> 10-hole	118mm L.
<b>J0407n</b>	<b>Plate.</b> 10-hole	130mm L.

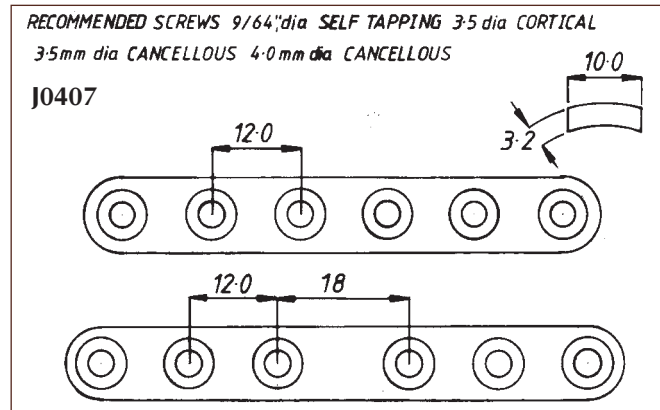

**3.5mm Heavy-Duty Round-Hole Plate.** 12mm W, 4mm thick heavy-duty plate is stronger than either the 3.5mm compression plate or our 3.5mm standard round-hole plate. Use of this plate makes 3.5mm cortical or <sup>9</sup>/<sub>64</sub>" screws appropriate for the larger canine breeds.

<b>J0408a</b>	<b>Plate.</b> 8-hole	104mm L.
<b>J0408b</b>	<b>Plate.</b> 9-hole	117mm L.
<b>J0408c</b>	<b>Plate.</b> 10-hole	130mm L.
<b>J0408d</b>	<b>Plate.</b> 11-hole	143mm L.
<b>J0408e</b>	<b>Plate.</b> 12-hole	156mm L.
<b>J0408f</b>	<b>Plate.</b> 13-hole	169mm L.
<b>J0408g</b>	<b>Plate.</b> 14-hole	180mm L.
<b>J0408h</b>	<b>Plate.</b> 15-hole	195mm L.

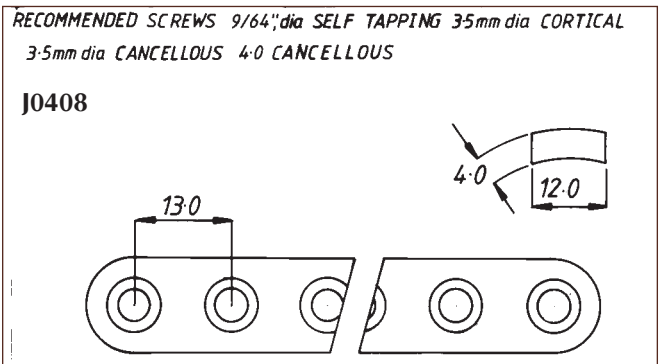



**Compression Plate and Cortical Screws.** The object of compression is to provide primary bone healing. A special guide is used to position the pilot drill hole. The corresponding tap then cuts the thread path. As the cortical screws are tightened through the unique plate holes, they are forced away from the side of the hole toward the fracture site. Compression of both fragments is then achieved.

Set includes instrumentation and an assortment of implants for plating and lag screw procedures.

**J0429 3.5mm Compression Bone Plating Kit.**

For self-tapping screws, use J0429a

1 x J0372cz	<b>Drill Bit.</b>	2.5mm
1 x J0372f	<b>Drill Bit.</b>	3.5mm
1 x J0414	<b>Drill Guide with point.</b>	3.5mm i.d.
1 x J0414bb	<b>Insert Sleeve.</b>	3.5mm o.d., 2.5mm i.d.
1 x J0409f	<b>Cortical Tap.</b>	3.5mm
1 x J0409d	<b>Cancellous Tap.</b>	4.0mm
1 x J0410	<b>Depth Gauge</b>	(2.7-4.0mm)
1 x J0411c	<b>Load/Neutral Drill Guide.</b>	3.5mm plates
1 x J0412b	<b>Hex Head Screwdriver</b> for	2.7/3.5/4.0 screw with sleeve
1 x J0413	<b>Tap Handle.</b>	
1 x J0372w	<b>Small Countersink with T-handle</b>	(2.7-4.0mm)
1 x J0415c	<b>Tap Sleeve</b>	3.5mm
1 x J0853a	<b>Plate Benders</b>	



**3.5mm Cortical Screws (6pk)**

6 ea x J0421d	16mm
6 ea x J0421e	18mm
6 ea x J0421f	20mm
6 ea x J0421g	22mm
6 ea x J0421h	24mm
6 ea x J0421i	26mm
6 ea x J0421k	30mm

**4.0mm Cancellous Screws (6pk)**

6 ea x J0424h	4mm 24mm L
6 ea x J0424j	4mm 28mm L
6 ea x J0424e	4mm 18mm L

**3.5mm Compression Plates**

1 x J0422d	5 holes x 62mm
1 x J0422e	6 holes x 74mm
1 x J0422f	7 holes x 86mm
1 x J0422g	8 holes x 98mm

1 x J0429d **Stainless Steel Case.** 2.7/3.5mm screw rack. 10"L x 6"W x 2.5"D.

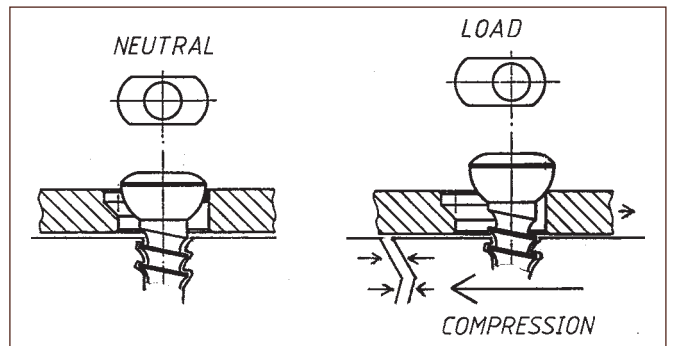

**J0429s 2mm Cortical Instrument/Implant Kit.**

J0412a	<b>Screwdriver</b> (2.0mm) with sleeve
J0409a	<b>Tap.</b> 2.0mm
J0372ax	<b>Drill Bit.</b> 1.5mm.
J0372b	<b>Drill Bit.</b> 2.0mm.
J0214s	<b>Handle</b> for 2.0mm tap.
J0411	<b>Load Neutral Drill Guide</b>
J0414aa	<b>Insert Sleeve.</b> 2.0mm O.D./1.5mm I.D.
J0429cs	<b>Stainless Steel Case with screw rack.</b>
J0410a	<b>Depth Gauge - mini.</b>

**2.0mm Cortical Screws: pack. of 6**

J0416a	6mm
J0416b	8mm
J0416c	10mm
J0416d	12mm
J0416e	14mm

**2.0mm Compression Plate.**

J0417a	4-hole
J0417b	5-hole
J0417c	6-hole
J0417d	7-hole
J0417e	8-hole



Not all plates shown are included in kit.

**Compression Plate and Cortical Screw.** By carefully positioning cortical screws in the special holes in compression plates, compression can be exerted at the reduced fracture site as the screw is tightened. As the head of the screw strikes the edge of the plate's hole, the screw (and the associated bone) are forced away from the edge of the hole and toward the fracture site.

The object of compression is to provide for primary bone union. A special guide must be used to position the screw hole accurately in the plate.

**Taps.**

- J0409a** **Cortical Tap.** 2.0mm. Dental fit. (Use **J0214s** Tap handle)
- J0409b** **Cortical Tap.** 2.7mm.
- J0409d** **Cancellous Tap.** 4.0mm. 1.75 pitch.
- J0409e** **Cortical Tap.** 4.5mm.
- J0409f** **Cortical Tap.** 3.5mm. 1.25 pitch.



**2mm Cortical Screws and Equipment.**

- J0412a** **Hex Screwdriver with sleeve,** 2.0mm screw.
- J0412as** **Sleeve** for above hex screwdriver.
- J0409a** **2.0mm Tap.**
- J0372a** **Pilot Hole Drill.** 1.6mm.
- J0372b** **Clearance Drill.** 2.0mm.
- J0410a** **Depth Gauge** for 2.0mm screw.

**2mm Cortical Screw.** Available in 6mm–24mm lengths, the spherical head of the screw produces compression when used in conjunction with 2mm compression plate.

- J0416a** **Cortical Screw.** 6mm L.
- J0416b** **Cortical Screw.** 8mm L.
- J0416c** **Cortical Screw.** 10mm L.
- J0416d** **Cortical Screw.** 12mm L.
- J0416e** **Cortical Screw.** 14mm L.
- J0416f** **Cortical Screw.** 16mm L.
- J0416g** **Cortical Screw.** 18mm L.
- J0416h** **Cortical Screw.** 20mm L.
- J0416i** **Cortical Screw.** 22mm L.
- J0416j** **Cortical Screw.** 24mm L.

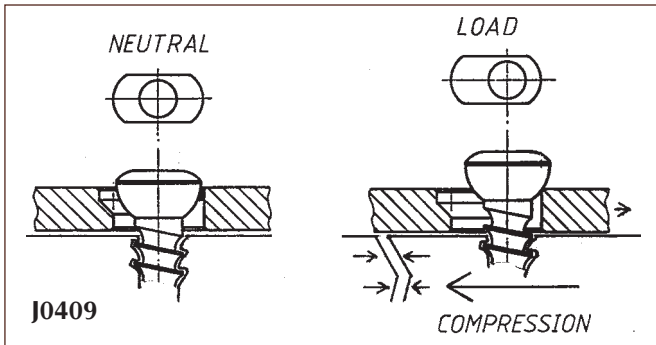

**2.2mm Cancellous Screw.** 1.5 pilot. 1.5 hex head. Self-tapping. Single pack.

- J0416bc** **Cancellous Screw.** 8mm L.
- J0416cc** **Cancellous Screw.** 10mm L.
- J0416dc** **Cancellous Screw.** 12mm L.
- J0416ec** **Cancellous Screw.** 14mm L.
- J0416fc** **Cancellous Screw.** 16mm L.
- J0416gc** **Cancellous Screw.** 18mm L.
- J0416hc** **Cancellous Screw.** 20mm L.
- J0416ic** **Cancellous Screw.** 22mm L.
- J0416jc** **Cancellous Screw.** 24mm L.

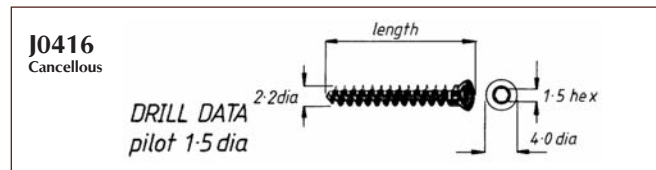
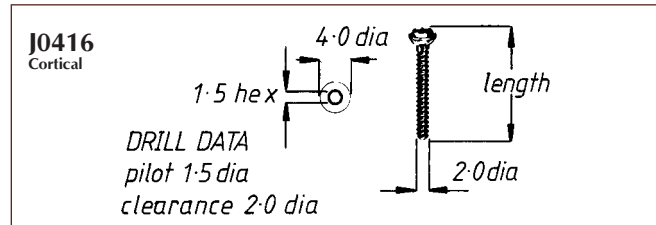

**2mm Compression Plate.** Use with 2mm cortical screws if compression is required.

- J0417a** **Plate.** 4-hole. 22mm L.
- J0417b** **Plate.** 5-hole. 27mm L.
- J0417c** **Plate.** 6-hole. 32mm L.
- J0417d** **Plate.** 7-hole. 37mm L.
- J0417e** **Plate.** 8-hole. 42mm L.

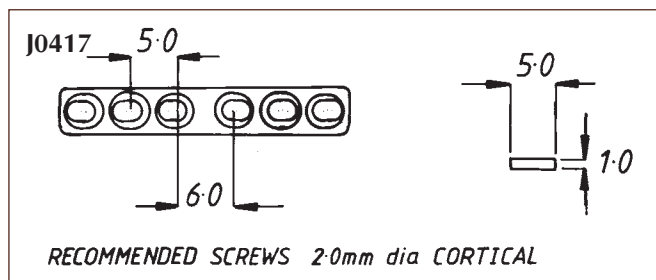

**Mini-Bone Plate.** 2mm.

- J0418a** **Plate.** 3-hole. 17mm L.
- J0418b** **Plate.** 4-hole. 23mm L.
- J0418c** **Plate.** 5-hole. 29mm L.
- J0418d** **Plate.** 6-hole. 35mm L.

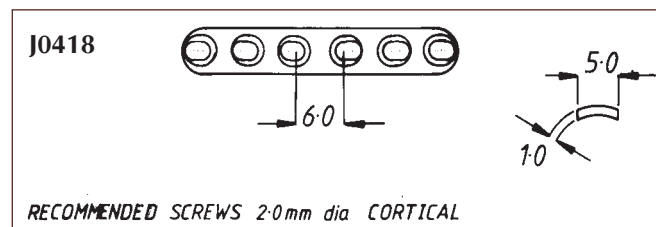

**2.4 DCPs and Screws.** On a regular basis we find that for many fractures in feline and small canine patients the regular 2.0 DCP is too small and the 2.7 DCP is too large. The difference between these plates is enormous compared to the difference between 2.7 and 3.5 DCPs. The AMI (resistance to bending) of the 2.7 DCP is 20 times stiffer than the 2.0 DCP. The AMI of the 2.4 DCP is 10 times that of the 2.0 DCP.

The solution is a 2.4 series of plates and screws. The plates in both size and strength are midway between 2.0 and 2.7 DCPs. The range and specifications are shown below. The standard 1.5mm hex screwdriver (used for 1.5 and 2.0 screws) is required. The pilot drill is 1.8mm and dedicated instrumentation such as load/neutral guides are also available as shown.

**2.4mm Cortical Self-Tapping Screws Hex Head 1.5 (use 1.8mm pilot)**

J1073aa	Cortical Self-Tapping Screw.	6mm x 2.4mm
J1073bb	Cortical Self-Tapping Screw.	8mm x 2.4mm
J1073a	Cortical Self-Tapping Screw.	10mm x 2.4mm
J1073b	Cortical Self-Tapping Screw.	12mm x 2.4mm
J1073c	Cortical Self-Tapping Screw.	14mm x 2.4mm
J1073d	Cortical Self-Tapping Screw.	16mm x 2.4mm
J1073e	Cortical Self-Tapping Screw.	18mm x 2.4mm
J1073f	Cortical Self-Tapping Screw.	20mm x 2.4mm
J1073g	Cortical Self-Tapping Screw.	22mm x 2.4mm
J1073h	Cortical Self-Tapping Screw.	24mm x 2.4mm
J1073i	Cortical Self-Tapping Screw.	26mm x 2.4mm
J1073j	Cortical Self-Tapping Screw.	28mm x 2.4mm
J1073k	Cortical Self-Tapping Screw.	30mm x 2.4mm
J1073L	Cortical Self-Tapping Screw.	32mm x 2.4mm
J1073m	Cortical Self-Tapping Screw.	34mm x 2.4mm
J1073n	Cortical Self-Tapping Screw.	36mm x 2.4mm
J1073p	Cortical Self-Tapping Screw.	38mm x 2.4mm
J1073q	Cortical Self-Tapping Screw.	40mm x 2.4mm

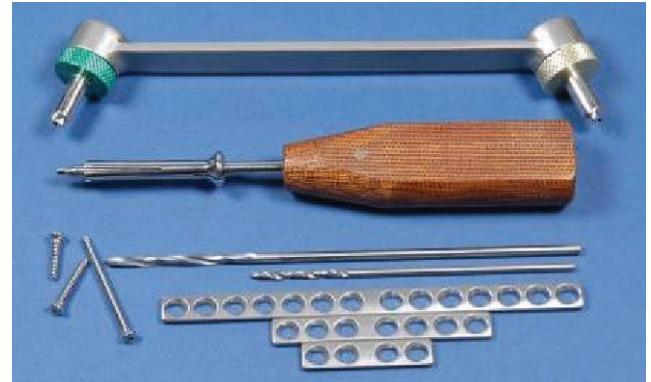

**J1073dcp** Kit including case, screws, plates, drills and load/neutral drill guide

**2.4mm Compression Plates.** 2.4 plate accepts 2.0, 2.4, and 2.7mm screws.

Code		Holes	Length mm
J1074a	2.4mm DCP	4	31
J1074b	2.4mm DCP	5	38
J1074c	2.4mm DCP	6	45
J1074d	2.4mm DCP	7	52
J1074e	2.4mm DCP	8	59
J1074f	2.4mm DCP	9	66
J1074g	2.4mm DCP	10	73
J1074h	2.4mm DCP	11	80
J1074i	2.4mm DCP	12	87
J1074j	2.4mm DCP	14	104
J1072a	1.8 pilot drill for 2.4 system	—	hard
J1072cd	2.4 clear drill for 2.4 system		
J1073Lng	Load/Neutral Drill Guide for 2.4 system		
J0412a	1.5 hex screwdriver for 1.5, 2.0 & 2.4mm screws		
J1073sip	Screw/Equipment box. 5.75" x 4" x 1.5"		

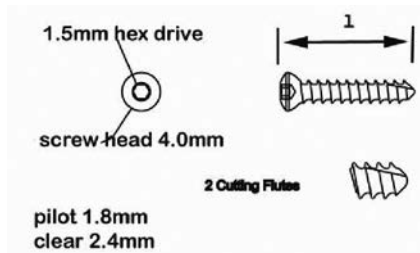
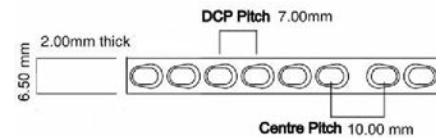
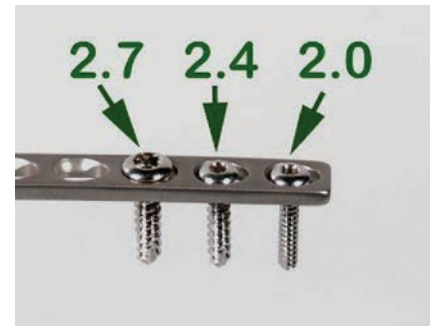

**2.4 PLATING KIT**

The 2.4 system is available as a boxed kit which includes one of each plate, 5 of each screw up to 30mm, drills, load/neutral guide and screwdriver.

**J1073dcp 2.4 Plating Kit**



## JorVet Plating Kits

JorVet Cortical and Cortical Self Tapping Kits in Premium Boxes

**J1219 1.5/2.0/2.4 Self Tapping Kit.** JorVet launches a range of Cortical Self Tapping Kits in Premium boxes. The boxes are designed with a screw tray, 2 insert trays for implants and the base compartment for instruments. Each kit contains all you need including screws and implants.

**J1219a 2.7/3.5 Cortical Bone plating kit in a premium box.**

See [www.jorvet.com](http://www.jorvet.com) for a complete list of kit items.

*An example of the 1.5/2.0/2.4 Self Tapping kit:*

- Hex screwdriver and sleeve
- Double drill guide/sleeve
- Screw length and depth gauge
- Depth gauge
- Load/neutral drill guide x2
- Insert sleeve x2
- Bending templates x2
- Bending levers x2
- Combination drill, tap, insert sleeve x2
- 5 drills
- 5 x 1.5 CSST screws 6mm – 20mm (40 in total)
- 5 x 2.0 CSST screws 6mm – 20mm (40 in total)
- 1 x DCP 4 – 8 hole (5 in total)
- 2 x T Plates
- 2 x Cuttable and cuttable/malleable plate
- 1 x Cuttable plate with spaces
- 2 x Cortical tap – dental fit
- 2 x Tap handle
- 1 x Cortical tap
- 5 x 2.4 CSST screws 6mm – 30mm (65 in total)
- 1 x DCP 4 – 14 hole (10 in total)
- Premium equipment/screwbox with insert trays



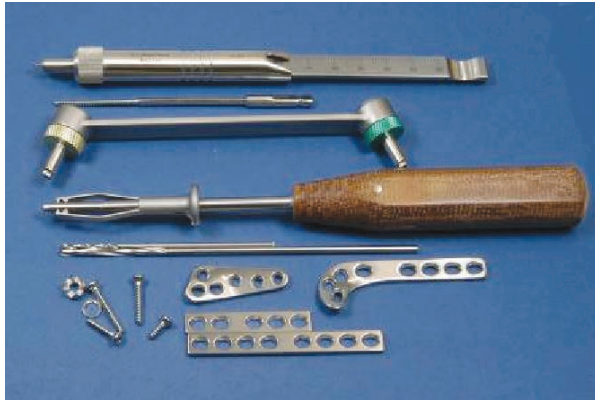

**2.7mm Cortical Screw and Equipment.**

- J0412b** Hex Screwdriver for 2.7-4.0mm screws with sleeve.
- J0409b** 2.7mm Tap.
- J0372b** 2.0mm Pilot Drill Bit. Round shaft.
- J0372d** 2.7mm Clearance Drill Bit. Round shaft.
- J0410** Depth Gauge. 2.7-4mm.
- J0413** Tap Handle for 2.7-4.5mm screws.

**2.7mm Cortical Screw.** Use with 2.7mm compression and 2.7mm reconstruction plates to obtain compression at a fracture site. 6/pk.

- |                              |                              |
|------------------------------|------------------------------|
| <b>J0419a</b> Screw. 6mm L.  | <b>J0419j</b> Screw. 24mm L. |
| <b>J0419b</b> Screw. 8mm L.  | <b>J0419k</b> Screw. 26mm L. |
| <b>J0419c</b> Screw. 10mm L. | <b>J0419l</b> Screw. 28mm L. |
| <b>J0419d</b> Screw. 12mm L. | <b>J0419m</b> Screw. 30mm L. |
| <b>J0419e</b> Screw. 14mm L. | <b>J0419n</b> Screw. 32mm L. |
| <b>J0419f</b> Screw. 16mm L. | <b>J0419o</b> Screw. 34mm L. |
| <b>J0419g</b> Screw. 18mm L. | <b>J0419p</b> Screw. 36mm L. |
| <b>J0419h</b> Screw. 20mm L. | <b>J0419q</b> Screw. 38mm L. |
| <b>J0419i</b> Screw. 22mm L. | <b>J0419r</b> Screw. 40mm L. |

Cortical screws now available with self-tapping threads. Sold in single packs. (Add the letter "S" after each code.)

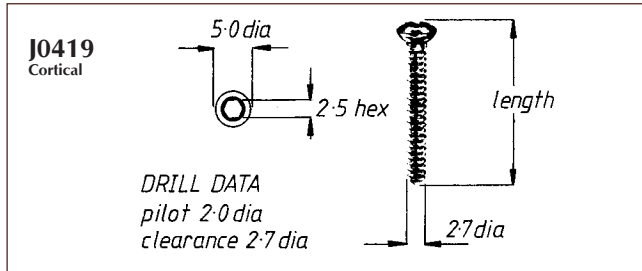

**2.7mm Compression Plate.** Use with 2.7mm cortical screws to produce fracture-site compression.

- |                              |          |
|------------------------------|----------|
| <b>J0420a</b> Plate. 2-hole  | 20mm L.  |
| <b>J0420b</b> Plate. 4-hole  | 36mm L.  |
| <b>J0420c</b> Plate. 5-hole  | 44mm L.  |
| <b>J0420d</b> Plate. 6-hole  | 52mm L.  |
| <b>J0420e</b> Plate. 7-hole  | 60mm L.  |
| <b>J0420f</b> Plate. 8-hole  | 68mm L.  |
| <b>J0420g</b> Plate. 9-hole  | 76mm L.  |
| <b>J0420h</b> Plate. 10-hole | 84mm L.  |
| <b>J0420i</b> Plate. 12-hole | 100mm L. |

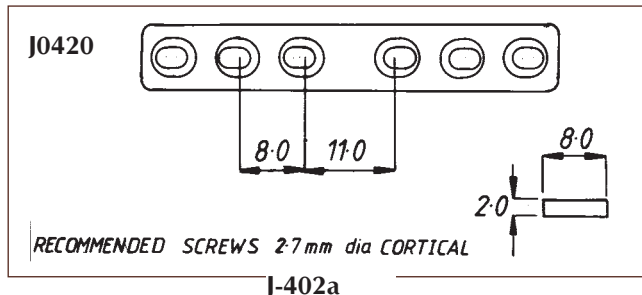

**3.0mm Cancellous Screw.** 2mm pilot. 2.5 hex head. Self-tapping. Single pack.

- |                               |                               |
|-------------------------------|-------------------------------|
| <b>J0419dc</b> Screw. 12mm L. | <b>J0419kc</b> Screw. 26mm L. |
| <b>J0419ec</b> Screw. 14mm L. | <b>J0419lc</b> Screw. 28mm L. |
| <b>J0419fc</b> Screw. 16mm L. | <b>J0419mc</b> Screw. 30mm L. |
| <b>J0419gc</b> Screw. 18mm L. | <b>J0419nc</b> Screw. 32mm L. |
| <b>J0419hc</b> Screw. 20mm L. | <b>J0419oc</b> Screw. 34mm L. |
| <b>J0419ic</b> Screw. 22mm L. | <b>J0419pc</b> Screw. 36mm L. |
| <b>J0419jc</b> Screw. 24mm L. |                               |

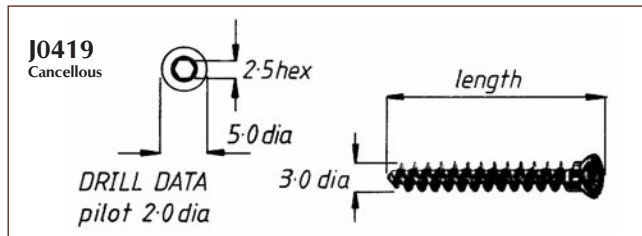

**3.5mm Screw and Equipment.**

- J0409f** 3.5mm Cortical Tap.
- J0413** Tap Handle. 2.7-4.5mm.
- J0372c** 2.5mm Pilot Hole Drill Bit.
- J0372f** 3.5mm Clearance Drill.
- J0411c** Load/Neutral Guide.
- J0410** Depth Gauge. 2.7-4.0mm.
- J0409c** 3.5mm Cancellous Tap.
- J0414bb** Insert Sleeve.
- J0412b** Hex Screwdriver and sleeve for 2.7-4.0mm cortical screws



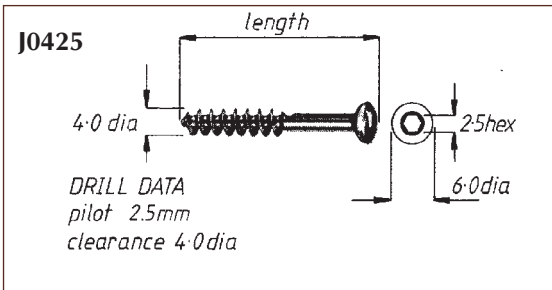
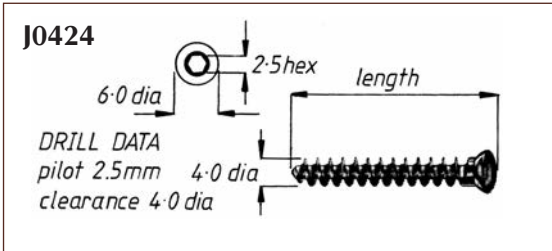
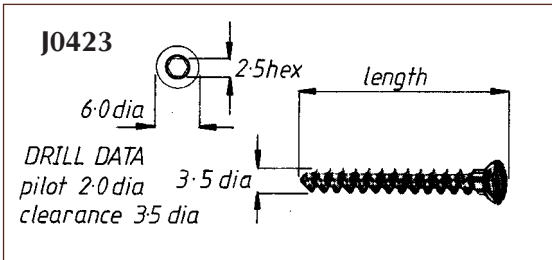
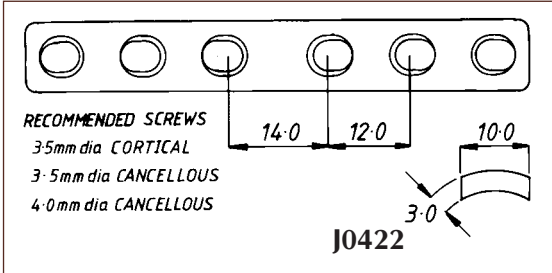
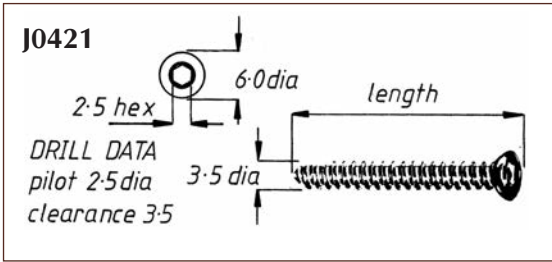

Self-Tapping Cortical Screws

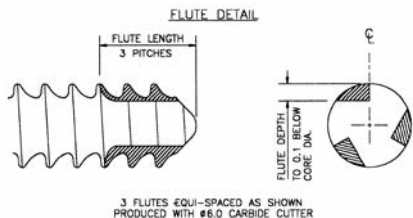

**3.5mm Cortical Screw.** 1.25 Pitch. Din 58812. Use with 3.5mm compression plates to obtain fracture-site compression. 6/pkg.

- |               |        |         |               |        |         |
|---------------|--------|---------|---------------|--------|---------|
| <b>J0421a</b> | Screw. | 10mm L. | <b>J0421k</b> | Screw. | 30mm L. |
| <b>J0421b</b> | Screw. | 12mm L. | <b>J0421l</b> | Screw. | 32mm L. |
| <b>J0421c</b> | Screw. | 14mm L. | <b>J0421m</b> | Screw. | 34mm L. |
| <b>J0421d</b> | Screw. | 16mm L. | <b>J0421n</b> | Screw. | 36mm L. |
| <b>J0421e</b> | Screw. | 18mm L. | <b>J0421o</b> | Screw. | 40mm L. |
| <b>J0421f</b> | Screw. | 20mm L. | <b>J0421p</b> | Screw. | 45mm L. |
| <b>J0421g</b> | Screw. | 22mm L. | <b>J0421q</b> | Screw. | 50mm L. |
| <b>J0421h</b> | Screw. | 24mm L. | <b>J0421r</b> | Screw. | 55mm L. |
| <b>J0421i</b> | Screw. | 26mm L. | <b>J0421s</b> | Screw. | 60mm L. |
| <b>J0421j</b> | Screw. | 28mm L. |               |        |         |

Cortical screws now available with self-tapping threads.  
Sold in single packs. (Add the letter "S" after each code.)

**Self-Tapping Screws.** Self-Tapping screws save time and work extremely well in most circumstances especially in the proximal tibia for TPLO and TTO. Available in 2.0, 2.4, 2.7 and 3.5mm diameters.

**3.5mm Compression Plate.** Use with 3.5mm cortical or 3.5mm cancellous screws to produce fracture compression.

- |               |        |                 |               |        |                   |
|---------------|--------|-----------------|---------------|--------|-------------------|
| <b>J0422a</b> | Plate. | 2-hole, 26mm L. | <b>J0422f</b> | Plate. | 7-hole, 86mm L.   |
| <b>J0422b</b> | Plate. | 3-hole, 38mm L. | <b>J0422g</b> | Plate. | 8-hole, 98mm L.   |
| <b>J0422c</b> | Plate. | 4-hole, 50mm L. | <b>J0422h</b> | Plate. | 10-hole, 122mm L. |
| <b>J0422d</b> | Plate. | 5-hole, 62mm L. | <b>J0422i</b> | Plate. | 12-hole, 146mm L. |
| <b>J0422e</b> | Plate. | 6-hole, 74mm L. |               |        |                   |

**3.5mm Broad Compression Plate.** Uses the larger width 4.5mm compression plate with holes for 3.5mm cortical screws. A heavy-duty compression plate for bigger dogs.

- |                |        |                   |                |        |                   |
|----------------|--------|-------------------|----------------|--------|-------------------|
| <b>J0422ba</b> | Plate. | 6-hole, 74mm L.   | <b>J0422bf</b> | Plate. | 11-hole, 134mm L. |
| <b>J0422bb</b> | Plate. | 7-hole, 87mm L.   | <b>J0422bg</b> | Plate. | 12-hole, 146mm L. |
| <b>J0422bc</b> | Plate. | 8-hole, 98mm L.   | <b>J0422bh</b> | Plate. | 13-hole, 158mm L. |
| <b>J0422bd</b> | Plate. | 9-hole, 110mm L.  | <b>J0422bi</b> | Plate. | 14-hole, 170mm L. |
| <b>J0422be</b> | Plate. | 10-hole, 122mm L. |                |        |                   |

**3.5mm Cancellous Screw.** 1.75 Pitch. The coarser thread has a much bigger "bite" into the bone. Use on metaphyseal or other cancellous bone. The screw needs its own tap. (J409c)

- |               |        |         |               |        |         |
|---------------|--------|---------|---------------|--------|---------|
| <b>J0423a</b> | Screw. | 10mm L. | <b>J0423k</b> | Screw. | 30mm L. |
| <b>J0423b</b> | Screw. | 12mm L. | <b>J0423l</b> | Screw. | 32mm L. |
| <b>J0423c</b> | Screw. | 14mm L. | <b>J0423m</b> | Screw. | 34mm L. |
| <b>J0423d</b> | Screw. | 16mm L. | <b>J0423n</b> | Screw. | 36mm L. |
| <b>J0423e</b> | Screw. | 18mm L. | <b>J0423o</b> | Screw. | 40mm L. |
| <b>J0423f</b> | Screw. | 20mm L. | <b>J0423p</b> | Screw. | 45mm L. |
| <b>J0423g</b> | Screw. | 22mm L. | <b>J0423q</b> | Screw. | 50mm L. |
| <b>J0423h</b> | Screw. | 24mm L. | <b>J0423r</b> | Screw. | 55mm L. |
| <b>J0423i</b> | Screw. | 26mm L. | <b>J0423s</b> | Screw. | 60mm L. |
| <b>J0423j</b> | Screw. | 28mm L. |               |        |         |

**4mm Cancellous Screw, Full Thread.** Use as cancellous screws where greater screw-bone interface is desirable. 6/pkg.

- |               |        |         |               |        |         |
|---------------|--------|---------|---------------|--------|---------|
| <b>J0424a</b> | Screw. | 10mm L. | <b>J0424h</b> | Screw. | 24mm L. |
| <b>J0424b</b> | Screw. | 12mm L. | <b>J0424i</b> | Screw. | 26mm L. |
| <b>J0424c</b> | Screw. | 14mm L. | <b>J0424j</b> | Screw. | 28mm L. |
| <b>J0424d</b> | Screw. | 16mm L. | <b>J0424k</b> | Screw. | 30mm L. |
| <b>J0424e</b> | Screw. | 18mm L. | <b>J0424l</b> | Screw. | 35mm L. |
| <b>J0424f</b> | Screw. | 20mm L. | <b>J0424m</b> | Screw. | 40mm L. |
| <b>J0424g</b> | Screw. | 22mm L. | <b>J0424n</b> | Screw. | 45mm L. |

**4mm Cancellous (Part Threaded) Lag Screw.** For use as a lag screw without over-drilling of proximal fragment. 1/pkg.

- |               |        |         |               |        |         |
|---------------|--------|---------|---------------|--------|---------|
| <b>J0425a</b> | Screw. | 10mm L. | <b>J0425h</b> | Screw. | 24mm L. |
| <b>J0425b</b> | Screw. | 12mm L. | <b>J0425i</b> | Screw. | 26mm L. |
| <b>J0425c</b> | Screw. | 14mm L. | <b>J0425j</b> | Screw. | 28mm L. |
| <b>J0425d</b> | Screw. | 16mm L. | <b>J0425k</b> | Screw. | 30mm L. |
| <b>J0425e</b> | Screw. | 18mm L. | <b>J0425l</b> | Screw. | 35mm L. |
| <b>J0425f</b> | Screw. | 20mm L. | <b>J0425m</b> | Screw. | 40mm L. |
| <b>J0425g</b> | Screw. | 22mm L. | <b>J0425n</b> | Screw. | 45mm L. |





**4.5mm Cortical Screw and Equipment.**

- J0412c **Hex Screwdriver** for 4.5mm screws.
- J0412cs **Sleeve** for above hex screwdriver.
- J0409e **4.5mm Cortical Tap.**
- J0413 **Tap Handle.**
- J0372e **3.2mm Pilot Hole Drill bit.**
- J0372h **4.5mm Clearance Drill Bit.**
- J0411d **Load/Neutral Drill Guide.**
- J0414g **Insert sleeve.** 3.2-4.5mm

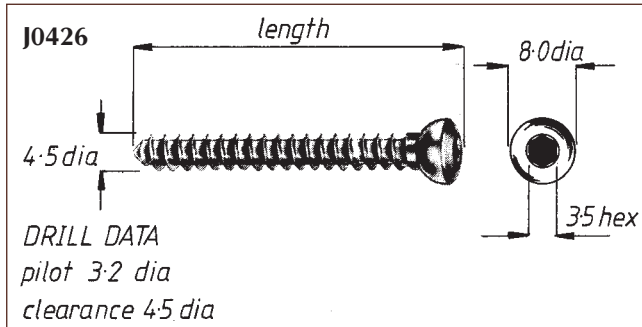

**4.5mm Cortical Screw.** This cortical screw is suitable for very large dogs and equine patients.

- |        |                       |        |                       |
|--------|-----------------------|--------|-----------------------|
| J0426a | <b>Screw.</b> 14mm L. | J0426g | <b>Screw.</b> 38mm L. |
| J0426b | <b>Screw.</b> 18mm L. | J0426h | <b>Screw.</b> 42mm L. |
| J0426c | <b>Screw.</b> 22mm L. | J0426i | <b>Screw.</b> 46mm L. |
| J0426d | <b>Screw.</b> 26mm L. | J0426j | <b>Screw.</b> 50mm L. |
| J0426e | <b>Screw.</b> 30mm L. | J0426k | <b>Screw.</b> 54mm L. |
| J0426f | <b>Screw.</b> 34mm L. | J0426l | <b>Screw.</b> 58mm L. |

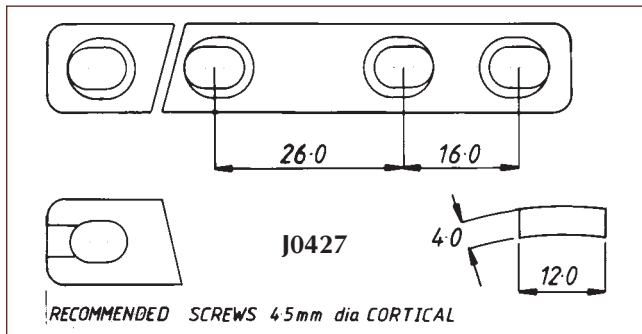

**4.5mm Compression Plate.** Use with 4.5mm cortical screws to produce fracture-site compression.

- |        |                        |          |
|--------|------------------------|----------|
| J0427a | <b>Plate.</b> 2-hole.  | 39mm L.  |
| J0427b | <b>Plate.</b> 3-hole.  | 55mm L.  |
| J0427c | <b>Plate.</b> 4-hole.  | 71mm L.  |
| J0427d | <b>Plate.</b> 5-hole.  | 87mm L.  |
| J0427e | <b>Plate.</b> 6-hole.  | 103mm L. |
| J0427f | <b>Plate.</b> 8-hole.  | 135mm L. |
| J0427g | <b>Plate.</b> 9-hole.  | 151mm L. |
| J0427h | <b>Plate.</b> 10-hole. | 167mm L. |
| J0427i | <b>Plate.</b> 11-hole. | 183mm L. |
| J0427j | <b>Plate.</b> 12-hole. | 199mm L. |

**4.5mm Broad Plates.** This is the strongest plate available for small animal orthopedics.

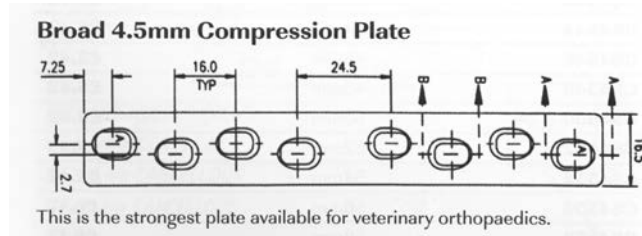

- |         |                       |          |
|---------|-----------------------|----------|
| J0427db | <b>Plate.</b> 5 hole  | 87mm L   |
| J0427eb | <b>Plate.</b> 6 hole  | 103mm L  |
| J0427fb | <b>Plate.</b> 7 hole  | 119mm L  |
| J0427gb | <b>Plate.</b> 8 hole  | 135mm L  |
| J0427hb | <b>Plate.</b> 9 hole  | 151mm L  |
| J0427ib | <b>Plate.</b> 10 hole | 167mm L  |
| J0427jb | <b>Plate.</b> 12 hole | 199mm L  |
| J0427kb | <b>Plate.</b> 13 hole | 215 mm L |
| J0427lb | <b>Plate.</b> 14 hole | 231mm L  |
| J0427mb | <b>Plate.</b> 15 hole | 247mm L  |
| J0427nb | <b>Plate.</b> 16 hole | 263mm L  |
| J0427ob | <b>Plate.</b> 17 hole | 279mm L  |
| J0427pb | <b>Plate.</b> 18 hole | 295mm L  |

J0374 series



**Reconstruction Bone Plates (cuttable and malleable).** Jorvet is pleased to introduce a full range of cuttable plates from 1.5mm through to 3.5mm. The holes are round and spaced to offer the maximum number of screws per bone fragment. Plates are contoured longitudinally for extra strength. Simply cut off as many holes as you need. The 2.0mm plates are available as cuttable/malleable versions and function as easily contoured reconstruction plates.

**Cuttible Bone Plates, 3.5mm and 2.7mm**

- J0374a** 2.7mm holes, 6mm spacing, 24 holes malleable
- J0374b** 2.0mm holes, 5mm spacing, 30 holes malleable
- J0374c** 2.0/2.4/2.7mm holes, 6mm spacing, 50 holes
- J0374d** 2.4mm holes, 5.5 spacing, 27 holes
- J0374e** 2.4mm holes, 5.5 spacing, 27 holes malleable
- J0374f** 2.0mm holes, 5mm spacing, 30 holes
- J0374g** 2.7mm holes, 6mm spacing, 25 holes
- J0374h** 1.5/2.0mm, 4mm spacing, 30 holes

**3.5mm Reconstruction Plates.**

	Holes	Length in mm
<b>J0374m</b>	5	58
<b>J0374n</b>	6	70
<b>J0374p</b>	7	82
<b>J0374q</b>	8	94
<b>J0374r</b>	10	118
<b>J0374s</b>	12	142

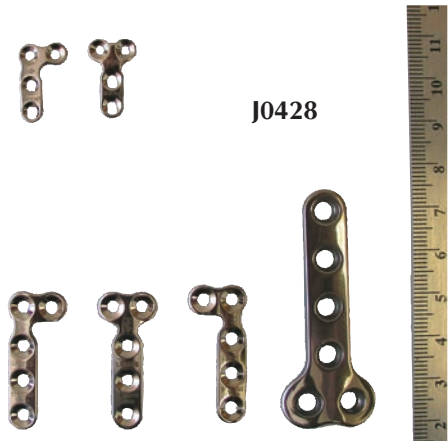

J0428

**“T” Plate.** Available for 3.5, 2.7, and 2.0mm screws, either cortical or self-tapping. “T” plates are used almost exclusively for the repair of fractures of the distal radius. In addition, they also may be used in a partial carpal arthrodesis.

- J0428a** “T” Plate. 2.0mm. 4-hole. 18mm.
- J0428b** “T” Plate. 2.0mm. 4-hole. Left angle. 18mm.
- J0428c** “T” Plate. 2.0mm. 4-hole. Right angle. 18mm.
- J0428d** “T” Plate. 2.7mm. 5-hole. 32mm.
- J0428e** “T” Plate. 2.7mm. 5-hole. Left angle. 32mm.
- J0428f** “T” Plate. 2.7mm. 5-hole. Right angle. 32mm.
- J0428g** “T” Plate. 3.5mm. 6-hole. 55mm.

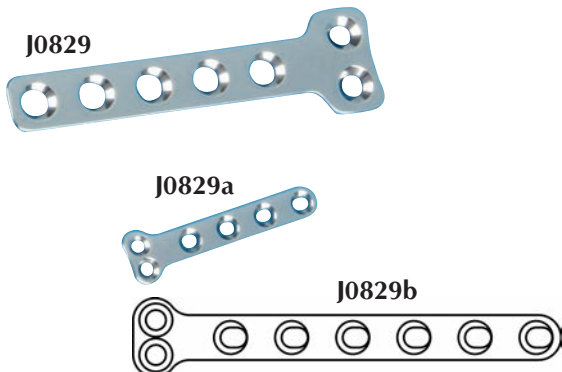

J0829

J0829a

J0829b

**Hybrid “T” Plates.** The problem with many distal radius fractures is the distal segment is so small that it is difficult to place sufficient screws. A “T” plate can help but often the head of the plate is too wide. Hybrid “T” plates can provide a solution.

- Screw holes in the head are smaller and closer together than those in the shaft
- Plate will accept same size screw in the head as in the shaft, but with reduced screw angulations.

- J0829** Hybrid “T” Plate. 2.7 or 3.5mm head  
3.5mm shaft 62mm length of shaft
- J0829a** Hybrid “T” Plate. 1.5 or 2mm head  
2mm shaft 32mm length of shaft
- J0829b** Hybrid “T” Plate. 1.5 or 2mm head  
2mm shaft 50mm length of shaft

*Note: J-829a and J-829b are especially suitable for distal radius fractures in cats and miniature dogs.*



J0428p & J0428q



J1076 series

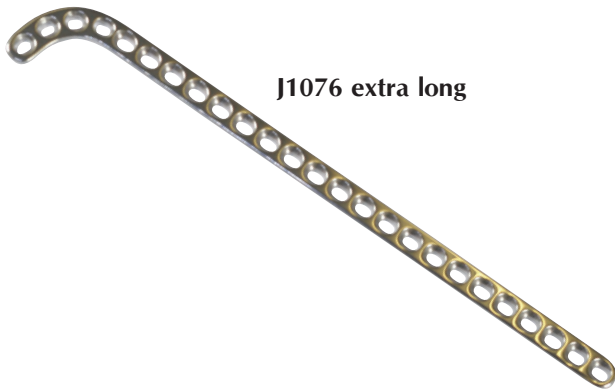
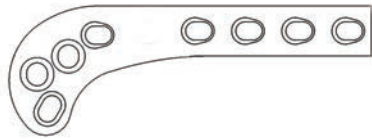

J1076 extra long



J0373a-f



**Distal Femur Plate.** Fracture repair in the Supracondylar femur region can be challenging, particularly in medium to large dogs. Forces acting on this region are complex and must be neutralized. In addition, the bone shape makes the use of standard plates virtually impossible.

JorVet supracondylar plates are designed to fit the distal femur with a minimum of further contouring. These plates are curved on the distal end to follow the natural bone curvature. The plate thickness tapers distally from 1.5mm to 1mm on 2mm plates.

In cats and small dogs supracondylar fractures are usually simple and transverse, hence the 2mm plates are relatively lightweight. Medium and larger dogs typically have more complex fractures at this site with multiple fragments, requiring much more plate support. Our 2.7 and 3.5 plate's shape and strength reflect this. Apply the plate when possible to the lateral surface of the femur.

J0428q	<b>2.0mm Supracondylar Plate.</b> Right.	50mm L.
J0428p	<b>2.0mm Supracondylar Plate.</b> Left.	50mm L.
J0428r	<b>2.7mm Supracondylar Plate.</b> Right.	70mm.
J0428s	<b>2.7mm Supracondylar Plate.</b> Left.	70mm.
J0428t	<b>3.5mm Supracondylar Plate.</b> Right.	170mm.
J0428u	<b>3.5mm Supracondylar Plate.</b> Left.	170mm.

**Supra Condylar Osteotomy Plates (SCOP).** Osteotomy of the distal femur is now a recognized technique for the management of patella luxation in medium and larger dogs with added femoral abnormality. The use of straight plates is difficult due to hole positioning and plate contouring. These supra condylar plates are computer designed to fit this area. Pre-contoured to minimize intra operative adjustments. For complex supra condylar fractures use our large supra condylar plates or distal femoral plates (see above).

J1076	<b>Supra condylar osteotomy plate</b> 2.7mm right
J1076a	<b>Supra condylar osteotomy plate</b> 2.7mm left
J1076b	<b>Supra condylar osteotomy plate</b> 3.5mm right
J1076c	<b>Supra condylar osteotomy plate</b> 3.5mm left
J1076d	<b>Supra condylar osteotomy plate</b> 2.4mm left
J1076e	<b>Supra condylar osteotomy plate</b> 2.4mm right

**Supra Condylar Plates.** Supracondylar femoral fractures in mature animals can be very difficult to repair. Small fragment size makes placement or sufficient implants a challenge. In medium and large dogs there are often multiple small fragments in the supracondylar area. The forces acting on the distal femur are complex requiring a special plate to neutralize them. The 2.7 and 3.5mm plates were developed by Mark Glyde using finite element analysis. Available in a range of sizes and lengths. 2.0, 2.7, 3.5 narrow and 3.5 broad (two lengths). Use bending templates to pre-contour plates.

**J1076f** **Extra Long Cuttable Supracondylar Plate 2.0mm,** 120mm extra long cuttable right shaft, width 5.5mm, shaft thickness 2mm.

**J1076g** **Extra Long Cuttable Supracondylar Plate 2.0mm,** 120mm extra long cuttable left shaft, width 5.5mm, shaft thickness 2mm

**Acetabular Bone Plates** are pre-contoured for a 3-dimensional fit.

J0373a	<b>Bone Plate.</b> Very small. Uses 2.0mm screws. 4 hole
J0373b	<b>Bone Plate.</b> Small. Uses 2.0mm screws. 4 hole
J0373c	<b>Bone Plate.</b> Medium. Uses 2.7mm screws. 6 hole
J0373d	<b>Bone Plate.</b> Large. Uses 2.7mm screws. 6 hole
J0373e	<b>Bone Plate.</b> X-Large. Uses 3.5mm screws. 6 hole
J0373f	<b>Bone Plate.</b> XX-Large. Uses 3.5mm screws. 6 hole



**Locking TPO and DPO Plates.** Triple Pelvic Osteotomy (TPO) and Double Pelvic Osteotomy (DPO) remain effective techniques for the management of hip dysplasia. Use of diverging, locking screws increases plate security as does the slightly larger footprint of our plates. Available in both 2.7 and 3.5 locking screw sizes at the following angles: 20, 25 and 30 degrees. Extra long locking drill guides are available.

- J1211L 3.5mm TPO/DPO Locking Plate 20 Left.
- J1211R 3.5mm TPO/DPO Locking Plate 20 Right.
- J1211La 3.5mm TPO/DPO Locking Plate 25 Left.
- J1211Ra 3.5mm TPO/DPO Locking Plate 25 Right.
- J1211Lb 3.5mm TPO/DPO Locking Plate 30 Left.
- J1211Rb 3.5mm TPO/DPO Locking Plate 30 Right.
- J1212L 2.7mm TPO/DPO Locking Plate 20 Left.
- J1212R 2.7mm TPO/DPO Locking Plate 20 Right.
- J1212La 2.7mm TPO/DPO Locking Plate 25 Left.
- J1212Ra 2.7mm TPO/DPO Locking Plate 25 Right.
- J1212Lb 2.7mm TPO/DPO Locking Plate 30 Left.
- J1212Rb 2.7mm TPO/DPO Locking Plate 30 Right.

**Triple Pelvic Osteotomy Plate (TPO).** The plates are supplied either flat or pre-bent. Thirty degrees rotation is most widely accepted.

- J0216 **Triple Osteotomy Plate.** 6-hole plate with 2 holes allowing compression designed specifically for triple osteotomy procedures. For use with 3.5mm x 4.0mm screws. Easily bend plate into desired angle. 4.5cm L. Flat.
- J0216a **Large TPO pre-bent,** 30-degrees left side, length 48mm
- J0216b **Large TPO pre-bent,** 30-degrees right side, length 48mm
- J0216c **Small TPO pre-bent,** 30-degrees left side, length 35mm
- J0216d **Small TPO pre-bent,** 30-degrees right side, length 35mm

**2.4 Locking Screws and Plate.** Jorvet 2.4 twin start locking screws (**J-1220 series**) are fully compatible with the industry standard. The 2.4 locking plates (**J1220 series**) are available in 4 to 18 hole sizes.

- J1220 **2.4mm Locking Screw** 2.4 head 6mm long
- J1220a **2.4mm Locking Screw** 2.4 head 8mm long
- J1220b **2.4mm Locking Screw** 2.4 head 10mm long
- J1220c **2.4mm Locking Screw** 2.4 head 12mm long
- J1220d **2.4mm Locking Screw** 2.4 head 14mm long
- J1220e **2.4mm Locking Screw** 2.4 head 16mm long
- J1220f **2.4mm Locking Screw** 2.4 head 18mm long
- J1220g **2.4mm Locking Screw** 2.4 head 20mm long
- J1220h **2.4mm Locking Screw** 2.4 head 22mm long
- J1220i **2.4mm Locking Screw** 2.4 head 24mm long
- J1220j **2.4mm Locking Screw** 2.4 head 26mm long
- J1220k **2.4mm Locking Screw** 2.4 head 28mm long
- J1220l **2.4mm Locking Screw** 2.4 head 30mm long
- J1220m **2.4mm Locking Screw** 2.4 head 32mm long
- J1220n **2.4mm Locking Screw** 2.4 head 34mm long
- J1220o **2.4mm Locking Screw** 2.4 head 36mm long
- J1220p **2.4mm Locking Screw** 2.4 head 38mm long
- J1220q **2.4mm Locking Screw** 2.4 head 40mm long
- J1220br **2.4 Locking Screw Premium Box with Insert.**
- J1220bk **Complete 2.4mm Locking Screw and Plate Kit in Premium Box.**



- J0438dgL 3.5mm Locking Screw Drill Guide.
- J1133dgR 3.5mm Locking Screw Drill Guide.

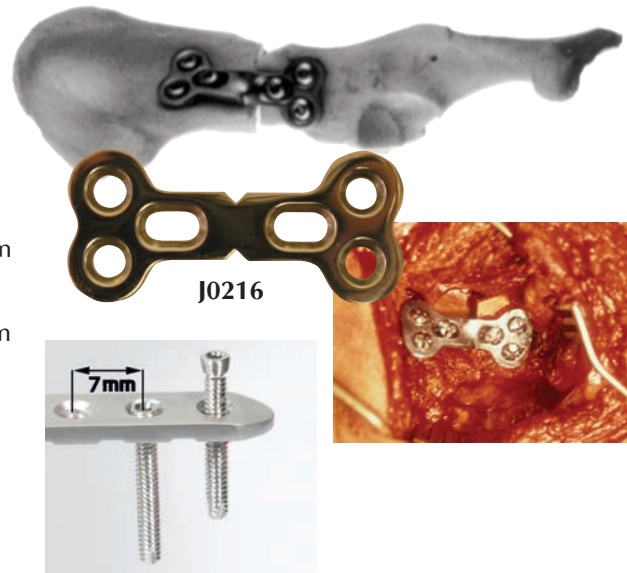

**2.4 Locking Hole Plate.** Jorvet 2.4 locking plates have stacked locking holes as is the case with our 2.7 plates. The twin start hole in the plate is the same size as the 2.7 screws, cortical 2.4, cortical 2.7, and cancellous 3.0. Hole spacing is 7mm.

- J1221 **Locking Hole Plate** 4 hole 31mm long
- J1221a **Locking Hole Plate** 5 hole 38mm long
- J1221b **Locking Hole Plate** 6 hole 45mm long
- J1221c **Locking Hole Plate** 7 hole 52mm long
- J1221d **Locking Hole Plate** 8 hole 59mm long
- J1221e **Locking Hole Plate** 9 hole 66mm long
- J1221f **Locking Hole Plate** 10 hole 73mm long
- J1221g **Locking Hole Plate** 11 hole 80mm long
- J1221h **Locking Hole Plate** 12 hole 87mm long
- J1221i **Locking Hole Plate** 13 hole 94mm long
- J1221j **Locking Hole Plate** 14 hole 101mm long
- J1221k **Locking Hole Plate** 15 hole 108mm long
- J1221l **Locking Hole Plate** 16 hole 115mm long
- J1221m **Locking Hole Plate** 17 hole 122mm long
- J1221n **Locking Hole Plate** 18 hole 129mm long
- J1220br **2.4 Locking Screw Premium Box with Insert.**
- J1220bk **Complete 2.4mm Locking Screw and Plate Kit in Premium Box.**

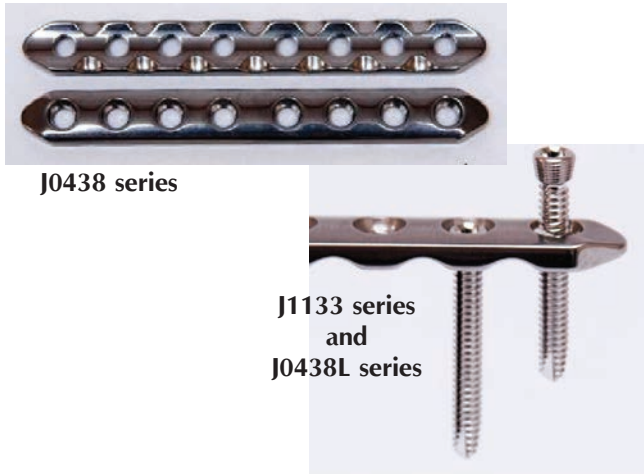

J0438 series

J1133 series  
and  
J0438L series



J0438L

**J0438L 3.5mm locking plate/screw starter kit.** This kit provides everything to get started with 3.5mm locking screws and plates.

- Included are one of each size plate (11 total)
- Locking screws (92 total) (J0438L screw series)

**Screws:**

3 x 12mm	4 x 26mm
3 x 14mm	4 x 40mm
3 x 16mm	4 x 42mm
3 x 18mm	4 x 44mm
3 x 20mm	4 x 46mm
3 x 50mm	4 x 48mm
3 x 52mm	5 x 28mm
3 x 54mm	5 x 30mm
3 x 56mm	5 x 32mm
3 x 58mm	5 x 34mm
4 x 22mm	5 x 36mm
4 x 24mm	5 x 38mm

- 5 x 3.5mm locking plugs
- 2.5mm pilot bone drill
- 3.5 locking screw drill guide
- Stainless case for screws and instruments 11" x 5.5" x 3.5"

**J1133s 2.7mm Locking Plug.**

Use to protect locking holes during contouring.

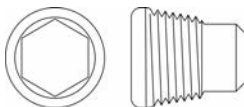

**J0438p 2.7/3.5mm Locking plug.** Used to protect locking holes while contouring plate (not pictured).

**Locking Screws and Plates.** A construct using locking plates and screws acts as an internal/external fixator. The construct is stiffer than conventional plates and screws and will require less contouring as it is not essential that the plate contacts the bone. Locking plates and screws are particularly popular in TPLO where significant savings in time (and morbidity) can be made. Also useful in fracture work in situations where contouring and rigidity is a challenge. The head of Jorvet locking screws engages the plate in the standard format using a twin start fine thread. Jorvet screws are an exact fit for standard locking plates but utilize the conventional hex screwdriver rather than a star screwdriver.

Locking screws are available in both 2.7 and 3.5 screw diameters. Each size requires its own dedicated drill guide. Jorvet locking plates have 'stacked' locking holes which allow more screws per bone fragment compared with dual hole type plates.

**Locking Plates 3.5mm**

Code	Screw hole	Plate length	Code	Screw hole	Plate length
J0438LHP-5	5	52	J0438LHP-10	10	102
J0438LHP-6	6	62	J0438LHP-11	11	112
J0438LHP-7	7	72	J0438LHP-12	12	122
J0438LHP-8	8	82	J0438LHP-13	13	132
J0438LHP-9	9	92	J0438LHP-14	14	142

**Locking Plates 2.7mm**

J1132a	4 hole
J1132b	5 hole
J1132c	6 hole
J1132d	7 hole
J1132e	8 hole
J1132f	9 hole
J1132g	10 hole
J1132h	11 hole
J1132i	12 hole
J1132j	13 hole
J1132k	14 hole

**Locking Screws 3.5mm**

J0438La	12mm
J0438Lb	14mm
J0438Lc	16mm
J0438Ld	18mm
J0438Le	20mm
J0438Lf	22mm
J0438Lg	24mm
J0438Lh	26mm
J0438Lj	28mm
J0438Lk	30mm
J0438Lm	32mm
J0438Ln	34mm
J0438Lp	36mm
J0438Lq	38mm
J0438Lr	40mm
J0438Ls	42mm
J0438Lt	44mm
J0438Lu	46mm
J0438Lv	48mm
J0438Lw	50mm
J0438Lx	52mm
J0438Ly	54mm
J0438Lz	56mm
J0438Lzz	58mm
J0372d	2.7mm pilot drill

**Locking Screws 2.7mm**

J1133a	6mm
J1133b	8mm
J1133c	10mm
J1133d	12mm
J1133e	14mm
J1133f	16mm
J1133g	18mm
J1133h	20mm
J1133i	22mm
J1133j	24mm
J1133k	26mm
J1133L	28mm
J1133m	30mm
J1133n	32mm
J1133o	34mm
J1133p	36mm
J1133q	38mm
J1133r	40mm
J0372b	2.0mm pilot drill

**J0438dg 3.5mm locking screw drill guide.** The locking screw requires precise drilling to match threaded screw head to plate. It is essential to screw the guide into the plate prior to drilling the pilot hole.

**J1133dg 2.7mm locking screw drill guide.**



**NEW**

**Evolox™ Bone Plate System.** Plates with threaded locking screws at a fixed angle are now widely used. The Evolox™ system is the next logical progression to allow the surgeon freedom on the angular placement of fixation screws.

- Can use either conventional non-locking screws or compatible locking screws (JorVet, Synthes)
- Both screw types can be positioned up to 10° of angulation
- Plate bending: greatly reduced need for anatomical form of plate as screw head is locked onto the plate
- Fragment reduction: aids individual fragment fixation by allowing screws to angle and lock towards the core of the bone rather than be limited to straight perpendicular present screws must follow.
- Crumple zones: plates in the Evolox™ range that require bending have crumple zones. They control the movement of material and direct distortion away from the locking hole. Locking plugs should be used for added protection.

**Evolox™ Reconstruction Plate (string of pearls) 3.5mm screw holes**

<b>J1330a</b>	4 holes x 45mm	<b>J1330h</b>	11 holes x 129mm
<b>J1330b</b>	5 holes x 57mm	<b>J1330i</b>	12 holes x 141mm
<b>J1330c</b>	6 holes x 69mm	<b>J1330j</b>	13 holes x 153mm
<b>J1330d</b>	7 holes x 81mm	<b>J1330k</b>	14 holes x 165mm
<b>J1330e</b>	8 holes x 93mm	<b>J1330m</b>	15 holes x 177mm
<b>J1330f</b>	9 holes x 105mm	<b>J1330n</b>	16 holes x 189mm
<b>J1330g</b>	10 holes x 117mm		



**NEW**

**Evolox™ Biological healing plate: Buttress plate**

- Uses Evolox™ design 3.5mm screws
- Can use either standard or locking screws
- Can position at 15° angulation

<b>J1332a</b>	8 holes x 154mm	<b>J1332c</b>	7 holes x 130mm
<b>J1332b</b>	8 holes x 142mm	<b>J1332d</b>	7 holes x 120mm

**NEW**

**Headless Lag Screws.** These screws have a threaded head that allows them to be driven below the surface of the bone. Two different thread patterns on the shaft and the screw head. They pull the fracture together in lag fashion.

<b>J1334a</b>	2.0mm x 10mm	<b>J1334f</b>	2.7mm x 25mm
<b>J1334b</b>	2.0mm x 15mm	<b>J1334g</b>	3.5mm x 20mm
<b>J1334c</b>	2.0mm x 20mm	<b>J1334h</b>	3.5mm x 25mm
<b>J1334d</b>	2.7mm x 15mm	<b>J1334i</b>	3.5mm x 30mm
<b>J1334e</b>	2.7mm x 20mm		

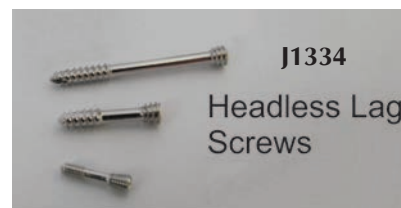

**NEW**

<b>J1336a</b>	<b>Mini H plates 2.0mm cuttable</b>
<b>J1336b</b>	<b>Mini H plates 2.0mm cuttable</b>
<b>J1337a</b>	<b>Mini T plates 2.0mm</b>
<b>J1337b</b>	<b>Mini T plates 2.0mm</b>

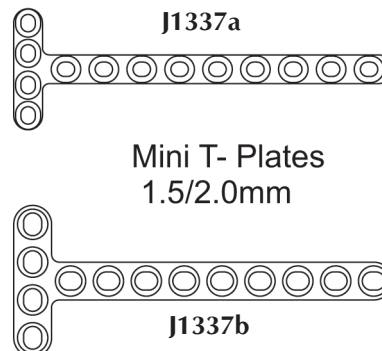
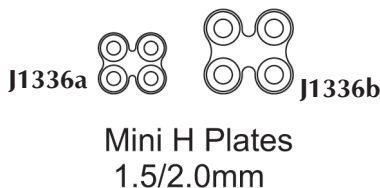



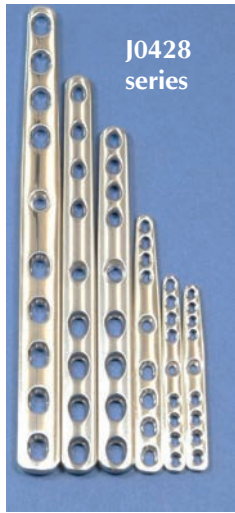

**Carpal Arthrodesis Plates.**

- J0428j**    **Compression.** 2.7mm/3.5mm. 112mm.
- J0428jL**    **2.7/3.5mm Pancarpal Locking Plate** 115mm length.
- J0428jxL**    **Carpal Arthrodesis Compression.** Extended length to increase over metacarpals. 2.7mm/3.5mm. 118mm.
- J0428h**    **Round-Hole.** 2.7mm/3.5mm. 112mm.
- J0428k**    **Compression.** 2.0mm/2.7mm. 75mm.
- J0428L**    **Round-Hole.** 2.0mm/2.7mm. 75mm.
- J0428m**    **Broad Compression.** 3.5mm/3.5mm. 140mm.
- J0428n**    **Broad Round-Hole.** 3.5mm/3.5mm. 140mm.
- J0428y**    **Compression.** 2.0mm/2.0mm. (not pictured) 55mm.
- J0428w**    **Carpal Arthrodesis** 1.5/2.0mm DCP, 54mm

***Problem:** In a carpal arthrodesis the distal screws are often too large on a standard plate for the metacarpal bone.*

*The proximal four holes are larger and the distal four holes are smaller. The middle hole will take either size screw. The plate narrows and has a slight 4° bevel at the distal end.*

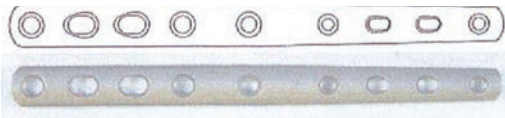

**J0428x**

**J0428x**    **2./3.5 Locking/Carpal Arthrodesis plate.** 2./3.5mm double hybrid. This plate includes both locking and DCP holes of both 2. and 3.5 screw sizes. The DCP holes on either side of the radial carpal bone screw allow compression and the locking screws offer angular security. The length is extended to give 50% plus coverage of the metacarpals. The radial carpal bone will accept both locking and regular screws according to surgeon preference.

**J0428z**    **Intertarsal Arthrodesis Compression Plate** is slightly wider and the holes are positioned to cover the metatarsal more completely. Middle hole picks up the central tarsal bone and T4. 2.0mm/2.7mm (sheltie size). (not pictured) 55mm.



**Partial Carpal Arthrodesis** Where the instability lies in the intercarpal or carpometacarpal joints and the radiocarpal joint is undamaged, partial carpal arthrodesis offers an outcome with a relatively normal range of movement. The problem is that the normal radiocarpal joint is capable of such a degree of extension that the distal radius tends to impinge on any implant placed onto the radial carpal bone. Partial carpal arthrodesis plates have been engineered to have an extremely low profile and the proximal screw holes are very close to the proximal border of the plate thereby minimizing the implant profile on the radial carpal bone. The proximal part of the plate is precontoured for best possible fit and to allow best position and angles of screws.

- J1223**    **Partial Carpal Arthrodesis Plate.** 2.7/3.5 x 65mm
- J1223a**    **Partial Carpal Arthrodesis Plate.** 2.0/2.4/2.7 x 50mm
- J1223b**    **Partial Carpal Arthrodesis Plate.** 1.4/2.0



**J0822d**

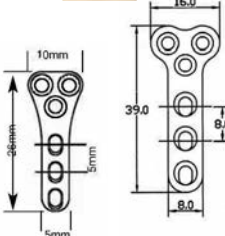

**J0822d**

**J0822a**

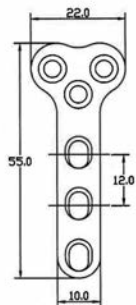

**J0822b**

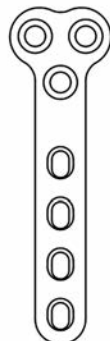

**J0822c**

**Tibial Wedge Osteotomy (TWO) Plates/Triple Tibial Osteotomy (TTO) plates.** These "T" plates are designed with 3 round holes in the top of the "T" and compression holes along the length of the shaft.

- J0822a**    **Tibial Wedge Plate.** 6-holes. 39mm L. Uses 2.7mm screws.
- J0822b**    **Tibial Wedge Plate.** 6-holes. 55mm L. Uses 3.5mm screws.
- J0822c**    **Tibial Wedge Plate.** 7-holes. 79mm L. Uses 3.5mm screws.
- J0822d**    **Tibial Wedge Plate.** 6-holes. 26mm L. Uses 2.0mm screws.

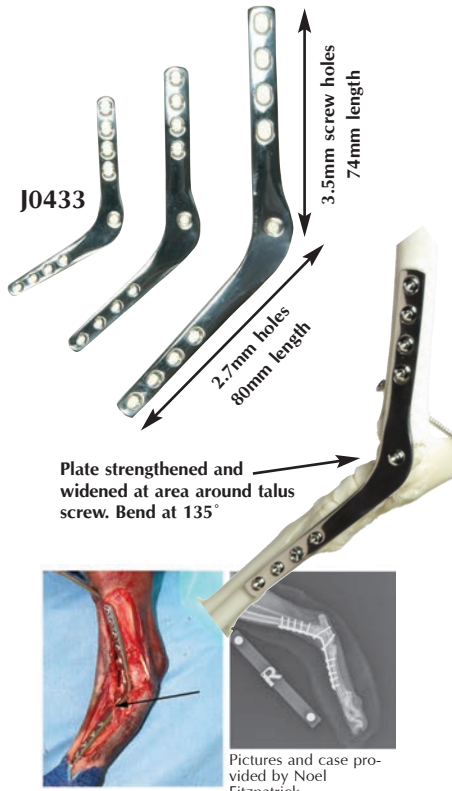

**Pantarsal Arthrodesis Plate.** The surgical immobilization of the hock joint can be difficult. A medially applied plate appears to best neutralize the effect of the long lever arm created by arthrodesis. Data from the manufacture of 50 custom plates has enabled JorVet to create a pantarsal plate which fits most medium and large dogs. The proximal portion is standard 3.5mm DCP, broadening over the vulnerable calcaneoquartal region, and finally tapering out over the metatarsals as a 2.7mm DCP.

- J0433** 2.7/3.5 Pantarsal Arthrodesis Plate. Right.
- J0433a** 2.7/3.5 Pantarsal Arthrodesis Plate. Left.

For small dogs. Overall length 100mm. 2.7mm/2.0mm screws.

- J0433bL** Left
- J0433br** Right

Our **Pantarsal Plate** is 135° with the middle screw placed in the center of the talus or the center of motion of the joint. This is not a one size fits all, but the only alternative is a custom plate. For cats. Overall length 78mm. 120° angle, better to match feline anatomy especially useful for severe shearing injuries. 2.7mm/2.0mm screws.

- J0433cr** Right
- J0433cl** Left

**Medial Pantarsal Plates with T4 Slot.** The original series of custom pantarsal plates which resulted in the original 'off the shelf plates' always included a screw hole between the metatarsals and the talus so that a screw could be placed to pick up the central tarsal bone plus T4 laterally. When we made a study prior to producing the 'off the shelf' pantarsal plate we found that the position of this hole was not predictable and if the surgeon was unlucky the screw placed could find itself in a joint space. We took the view that this screw was not essential and omitted it. We are unaware of any arthrodesis failures as a consequence.

However, cadaver studies by Loic Dejardin have shown that the placement of the additional screw adds significantly to the stiffness of the construct. Surgeons requesting custom plates seem to prefer plates with the extra hole. We are pleased to be able to offer a new series of pantarsal plates which have a slot over the T4 region which will allow the surgeon to collect the central tarsal bone and T4. After looking at all our custom pantarsal plates we have also taken the opportunity to add a smaller 2.7/3.5 plate.

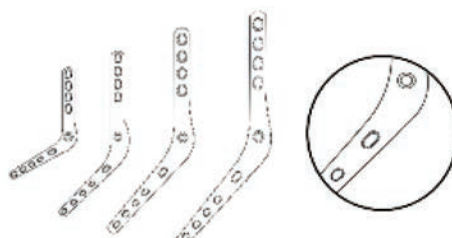

**J0433 Medial Plates with T4 Slot**

- J0433p** 2.7/3.5 Canine Pantarsal Plate with T4 Slot - Right Hand
- J0433q** 2.7/3.5 Canine Pantarsal Plate with T4 Slot - Left Hand
- J0433r** 2.7/3.5 Medial Pantarsal Arthrodesis Plate with T4 Slot - Right short
- J0433s** 2.7/3.5 Medial Pantarsal Arthrodesis Plate with T4 Slot - Left short
- J0433t** 2.0/2.7 Feline Pantarsal Plate with T4 Slot - 120°Right
- J0433u** 2.0/2.7 Feline Pantarsal Plate with T4 Slot - 120°Right
- J0433v** 2.7/3.5 Canine Pantarsal Plate with T4 Slot - Right Short
- J0433w** 2.7/3.5 Canine Pantarsal Plate with T4 Slot - Left Short



**J0433ys**

**Dorsal Pantarsal Arthrodesis Plates.** The latest version of the dorsal pantarsal arthrodesis plate, again developed by Noel Fitzpatrick includes some new important features. The possible angulation for the calcaneal screw has been increased. There are now two slots proximal to the bend to maximize screw options. The overall size is smaller making it suitable for medium. Both proximal and distal tips have been tapered down to ease introduction and to reduce the stress risers at the interface between plate and bone.

- J0433ys** 2.7/3.5 Dorsal Pantarsal Arthrodesis Plate Mid Size

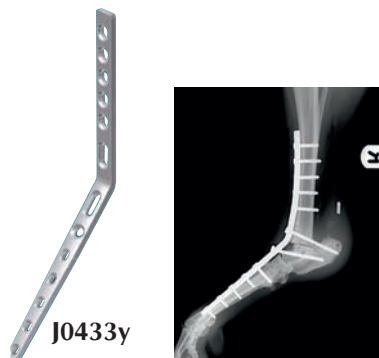

**J0433y**

- J0433x** 1.5/2.0 Cranial Pantarsal Plate (feline). Although requiring a little more dissection, application of the cranial plate permits the placement of stabilizing screws through the body of the talus into the calcaneus. Slotted holes on either side of the bend offer extensive screw angulation. Use of a cranial plate makes it easier to preserve the important perforating metatarsal artery (arrowed).

- J0433y** 2.7/3.5 Canine Cranial pantarsal plate. Although requiring more initial dissection than the medial approach, the cranial plate makes alignment easier and does not involve screwing metatarsals to each other. Stability across the talocrural joint is achieved by a screw which passes through the plate and crosses the joint into the calcaneus.

**Biological Healing Plates.** These plates are designed to bridge a section of shattered long bone. It effectively acts as a buttress plate. No attempt is made to reconstruct. The fracture site is not disturbed to minimize de-vitalization and contamination. The plate maintains the length and permits weight bearing. Use of these plates avoids leaving empty screw holes over the fracture site. Empty holes significantly weaken the construct. Use when proximal and distal sections are intact and the body of the femur are un-reconstructable. All plates have round holes as there is no need for compression.

<b>J0433d</b>	2.0mm	8 hole	65mm long – 6mm wide
<b>J0433e</b>	2.7mm	6 hole	68mm long – 7mm wide
<b>J0433f</b>	2.7mm	7 hole	67mm long – 7mm wide
<b>J0433g</b>	2.7mm	8 hole	75mm long – 7mm wide
<b>J0433h</b>	3.5mm	7 hole	120mm long – 10mm wide
<b>J0433j</b>	3.5mm	8 hole	130mm long – 10mm wide
<b>J0433k</b>	4.5mm	7 hole	138mm long – 10mm wide
<b>J0433m</b>	4.5mm	8 hole	150mm long – 10mm wide
<b>J0433n</b>	3.5mm	8 hole (Broad)	130mm long – 10mm wide



**Bone Plate Clip.** The storage of plates in an orderly fashion is desirable. This inexpensive clip allows plate storage with quick access while making proper plate selection easier.

- Holds up to eight plates
- ID tag identifies each plate size

<b>J0430pc</b>	<b>Plate Clip.</b>	3.5mm.
<b>J0430pca</b>	<b>Plate Clip.</b>	2.7mm.
<b>J0430pcb</b>	<b>Plate Clip.</b>	2.0mm.



**J0372m**

**J0372m Orthopedic Punched Hole Gauge.** Punched gauge allows accurate measurement of IM pins, orthopedic ruler/gauge and drill (Imperial).

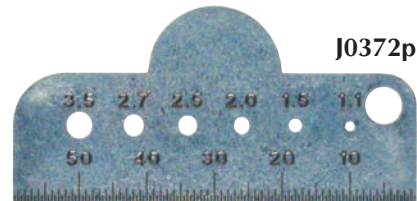

**J0372p**

**J0372p Bone Screw and Drill Bit Gauge.** (Metric)

**Cortical Nut.** Occasionally tapped threads strip and a larger screw is inappropriate. Lag screws are particularly vulnerable, as only one cortex is available for tapping. A cortical nut manufactured from implant grade nylon can give the screw purchase to allow normal tightening. The thread form is designed to grip the screw to minimize backing out. Sterile.

<b>J0375a</b>	<b>Cortical Nut.</b>	2.7mm.
<b>J0375b</b>	<b>Cortical Nut.</b>	3.5mm.
<b>J0375c</b>	<b>Cortical Nut.</b>	4.5mm. Stainless steel.

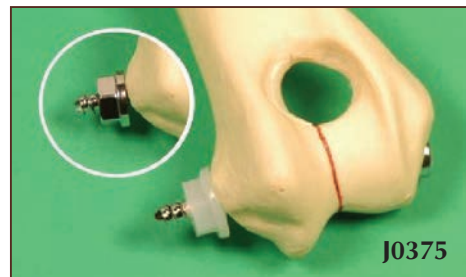

**J0375**

**J0912q Bone Wax.** This natural wax will control the seepage of blood from cut/cancellous bone, which obscures the visual field. The wax acts as a physical barrier. Sterile. 2.5gm packets. 10 packets/box.



**J0912q**



**Orthopedic Power Driver.** A power driver with features making it the best on the market. The power source is a high quality cordless reversible driver drill.

- 12 Volt  $\frac{3}{8}$ " drill
- Includes 2 Lithium Ion batteries
- AC charge base
- Torque Adjustment Collar
- Variable speed 2000-20,000RPM
- 30-60 minutes recharge time
- Dual Range Gears
- Weight 4.55 lbs
- Includes J0238s Drill shroud
- Includes J0238d1 Power drill extension with chuck and key.
- LED work light

**J0238m Orthopedic Drill set.**

**J0238d1 Power Drill Adapter with Chuck.** Converts any standard  $\frac{3}{8}$ " drill into your power driver. Features a  $3\frac{1}{2}$ " cannulated stainless steel shaft and stainless steel Jacobs chuck with  $\frac{1}{4}$ " capacity.

**J0238d1d Chuck Extension, only.** (chuck not included)

**J0238pdm Orthopedic Drill only.**

**J0238s Autoclavable Drill Shroud** with Velcro closure. Will fit any standard size drill.

**J0238sd Disposable Drill Shroud** fits any size drill. Special material has impervious inner layer. Provides full fluid repellency; top side has adhesive strip. Sterile. 5/pk. (not pictured)

**J0214 Small Jacobs Chuck.** Lightweight blue anodized aluminum. 120g. 14cm.

- Much finer, more delicate, and less than half the weight of standard chucks
- Ideal for small dogs and cats when using "k" wires and small pins up to  $\frac{5}{32}$ "
- Handle not slotted as **J0214L**

**J0214L Jacobs IM Pin Chuck.** Unique design on the standard instrument for introducing bone pins. An open slot cut into the handle permits visibility of the pin resting in the chuck, saving time by allowing the surgeon to check pin depth without having to remove the chuck. The stainless steel Jacobs accepts K-wires as small as 0.035" and pins as large as  $\frac{1}{4}$ ". The handle and extension piece are lightweight, blue anodized aluminum alloy. Key and extension piece included.  $10\frac{1}{2}$ "L.

**J0214Ld1 Jacobs Chuck & Key** only.

**J0214Ld2 Key** only.

**J0214Ld4 Handle** only.

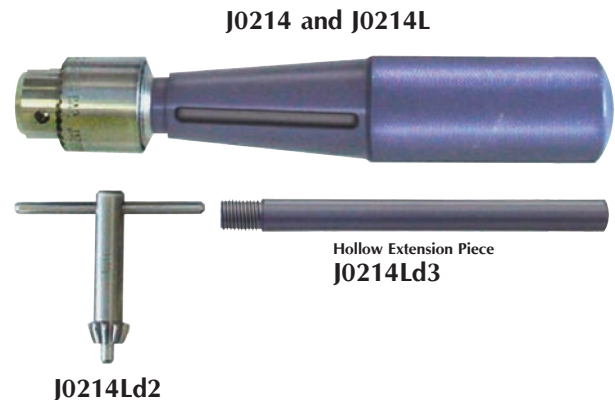

**J0866mr Cordless Power Saw with 2 Cast Cutting Blades.**

- 12 Volt
- 5,000-20,000 rpm
- Oscillation angle 3.2 degrees
- Battery charging time 30 minutes
- Lithium battery (2 included)
- 2 year limited warranty
- LED work light
- Weight 2.2 lbs
- Clear Plastic case for storage
- **J0866emr** included



**J0866kmr Cordless Orthopedic Power Saw Kit.**

- **J0866mr** Power Saw and accessories plus
- **J0866b** Sagittal Blade
- **J0866c** Sagittal Blade
- **J0866ex** Extension for Saw Blade
- **J0866s** Cloth Shroud



**J0866w Same as above without battery.** Plug-in wire for 110v AC.

This model also has a variable speed control knob.

**Accessories:**

**J0866a Cast Cutter Blade.**

**J0866b Sagittal Section Saw Blade.** Stainless steel. Best for TPO procedures. 1.2mm x 12mm x 70mm.

**J0866c Sagittal Section Saw Blade.** Stainless steel. 0.9mm x 12mm x 45mm.

**J0866f Multisaw blade.** 0.8mm cut thickness, 19.5mm width, 41mm length. Great blades for TTA or TTO procedure

**J0866g Multisaw blade.** 0.8mm cut thickness, 9mm wide, 41mm length. Great blades for TTA or TTO procedure.

**J0866e Extension Piece** for orthopedic saw blades.

**J0866s Cloth Shroud** (autoclaveable).

**J0866x TPLO Saw Blade Adapter.** This extension converts the multi-saw to allow the use of the triangular Stryker fit blades, including TPLO blades. 8mm wrench included. 4° oscillation

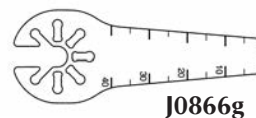
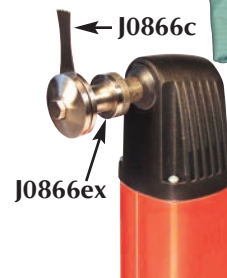

*NOTE: J0866x saw attachment will drive the blade at right angles to the long axis of the saw body. The blade may be positioned at any point around the perpendicular axis.*

**J0866y TPLO saw blade adapter.** Allows the triangular fitting on TPLO saws to take less expensive orthopedic saw blades that fit the Multimaster cordless. These blades would be the **J0866b** and **J0866c** sagittal saw blades shown above.



**J0094 Engel Cast Cutter.** Stainless steel blade. 5<sup>3</sup>/<sub>4</sub>".

**J0094h Beeson Cast Spreader.** Stainless steel. 12".

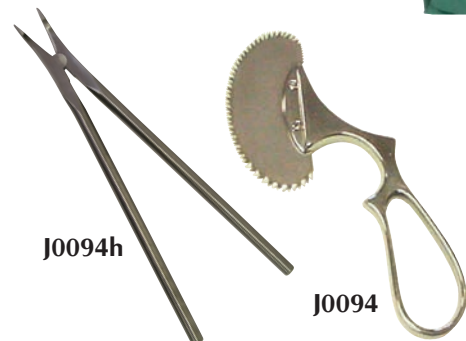

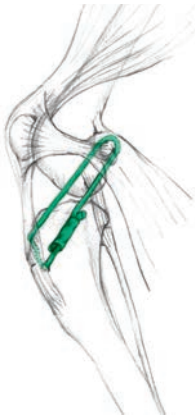

**Cranial Cruciate Ligament Lateral Suture System.** Treatment of Cranial Cruciate Ligament (CCL) rupture by placement of a lateral nylon suture has gained popularity among veterinary surgeons. The relatively quick procedure results are comparable to other techniques. Post operative strength of the repair is immediately good. Risks to intra-articular structures are minimal.

Method: Heavy monofilament nylon is first placed on the lateral side of the stifle. A metal crimp tube replaces the large knot normally required. Appropriate tension is placed on the suture. Then a crimp tube applied over the suture ends is held in place by the crimping forceps. The lateral nylon is placed behind the lateral fabella bone and then through the tibial tubercle.

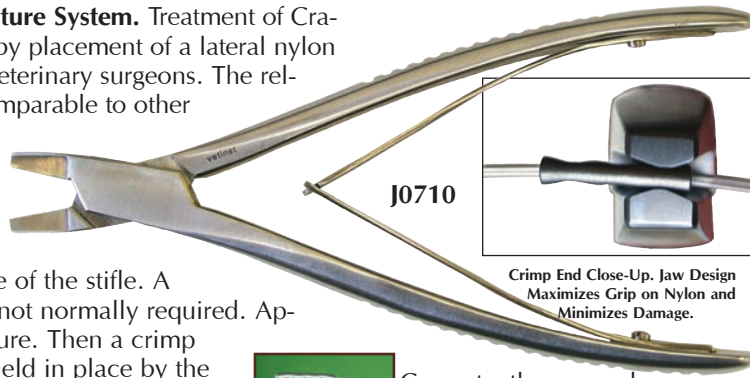

Crimp End Close-Up. Jaw Design Maximizes Grip on Nylon and Minimizes Damage.

**J0710 Crimping Forceps.** Designed with a flattened area on the forcep jaws that crimps the metal tubes evenly without risk of cutting the nylon suture. 7 1/2" L.



J0710xa series



Correct - three evenly spaced crimps.

Incorrect - not enough crimps.

Incorrect - crimps too close to the end of the tube.

**J0710xa Double Action Crimper.** 7 1/2" L. The double action gives a powerful precise crimp with ease. They will work on most crimp tubes, but are required for crimping LigaFiba. Tungsten carbide inserts with gold plated handles.

Heavy duty action works best on LigaFiba crimps (J0448a). Does not work with 10mm nylon crimp.



**Crimp Tube and Nylon "Ande" Leader Line Configurations:**

**Crimp Tube** only. Non-sterile.

**J0710b 10mm Crimp Tube.** For 50 lb. nylon leader line.

**J0710a 12mm Crimp Tube.** For 80 and 100 lb. nylon leader line.

**Crimp Tube with Nylon Line.** Sterile packed.

**J0710d 10mm Crimp Tube.** Plus 500mm 50 lb. (0.7mm) nylon leader line.

**J0710c 12mm Crimp Tube.** Plus 800mm 80 lb. (0.9mm) nylon leader line.

**J0710cg 12mm Crimp Tube.** Plus 800mm 100 lb. (1.0mm) nylon leader line.

**Nylon Line** only. Sterile packed.

**J0710f 500mm 50 lb. Nylon Leader Line.**

**J0710e 800mm 80 lb. Nylon Leader Line.**

**J0710g 800mm 100 lb. Nylon Leader Line.**

**Bulk Nylon Line.** Non-sterile. Ande brand.

**J0710eb 80 lb. Nylon Leader Line.** 50 yd. reel.

**J0710fb 50 lb. Nylon Leader Line.** 50 yd. reel.

**J0710gb 100 lb. Nylon Leader Line.** 50 yd. reel.



**Cruciate Training**

- Learn more at [www.JorVet.com](http://www.JorVet.com)
- A color pictorial step by step guide
- FAQ of the technique
- Videos of the procedure
- Free DVD of this procedure and other CCL repair techniques is available.

**Cruciate Suture Needle.** Designed for use with heavy nylon in the lateral suture repair method for cranial cruciate ruptures. Needles are specially curved along with a heavier body, making passage around the femur/fabella area much easier. Stainless steel.

**J0710w Cruciate Suture Needle.** X-Small. 15mm dia. 6/pk. (not pictured)

**J0710x Cruciate Suture Needle.** Small. 6/pk.

**J0710y Cruciate Suture Needle.** Medium. 6/pk.

**J0710z Cruciate Suture Needle.** Large. 6/pk.

**Cruciate Needle.** Swaged onto nylon suture. Includes crimp tube. Sterile.

**J0710k 15mm X-Small Cruciate Needle.** Swaged onto 50 lb. nylon leader line with 10mm crimp tube. 500mm L.

**J0710m 20mm Small Cruciate Needle.** Swaged onto 80 lb. nylon leader line with 12mm crimp tube. 800mm L.

**J0710p 25mm Medium Cruciate Needle.** Swaged onto 100 lb. nylon leader line with 12mm crimp tube. 800mm L.



J0710b



J0710a

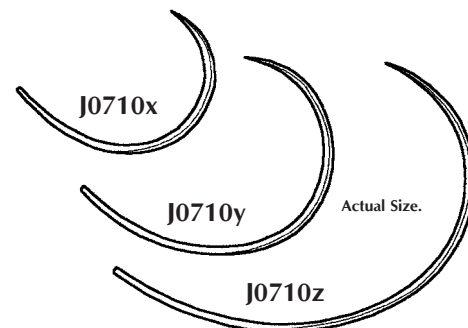

Actual Size.



**CCL Lateral Suture System Double Swaged-On Line and Needle.** Some CCL deficient patients benefit from the use of double sutures. This is particularly true of very large dogs and 100 lb line. Passing a second needle behind the fabella risks damaging the first line and the peri-fabellar structures which ultimately will hold the nylon sutures.

Double line, Swaged-on sutures allow the placement of two lines with one pass of the needle. Available as single sterile packs with or without crimps. The double line is supplied Swaged on as a loop and will, therefore, be of interest to those surgeons using the self-locking McKee/Miller knot (VCOT 1999/12:78-80)

**Double Line and Needle** without crimp tube.

**J0710md 800mm x 2 Line.** 80 lb. / Small Needle.

**Double Line, Needle and Crimps (2).**

**J0710ke 500mm x 2 Line.** 50 lb. / X-Small Needle, Plus 10mm Crimps.

**J0710me 800mm x 2 Line.** 80 lb. / Small Needle, Plus 12mm Crimps.

**J0710pe 800mm x 2 Line.** 100 lb. / Medium Needle, Plus 12mm Crimps.

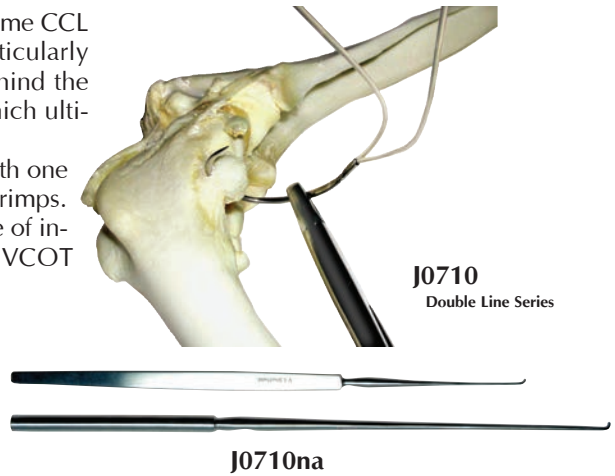

**JorVet offers two crimping systems and nylon line.** The original JorVet system designed around the Ande brand of nylon line is the J-710 series. The Mason brand nylon line and crimp tubes are the J-1070 series. These crimp tubes are designed to work with the Mason brand of nylon line. Both line and tubes are comparable to the Securos® system. Tubes are implant grade steel made with polished seamless tubing.

**Mason Line Crimp Tubes.** These crimp tubes are specifically designed to be compatible with Mason brand of nylon line also used in the Securos® brand crimp tube range. All stainless implants grade with polished seamless tubing.

**J1070 40# crimp tube 15pk**

**J1070a 80# crimp tube 15pk**

**J1070b 100# crimp tube 15pk**

These 3 crimp tubes (J1070, J1070a, and J1070b) all require the Jorvet J010XA crimper or the Securos brand crimper.

Mason line swaged on various special sterile cruciate needles.

**J1070kb 40lb double nylon line with medium cruciate needle**

**J1070mb 80lb nylon with small cruciate needle**

**J1070mf 80lb double nylon line with small needle**

**J1070pd 100lb double Mason line with medium needle**

Mason nylon line 100yd spools.

**J0714 20lb**

**J0714a 40lb**

**J0714c 80lb**

**J0714d 100lb**

Securos® Corp., Charleton, MA

**Lateral Button Suture.** During the placement of standard lateral sutures there is a tendency for the proximal strand of the suture to drift up the straight patella ligament. This reduces the isometry of the suture and the suture can become intra-articular which is undesirable. Use of a toggle button at the proximal tibia hole keeps both strands of suture at the hole. Application is very simple. The suture is passed around the fabella using the swaged on curved cruciate needle. The suture is then passed through the hole from lateral to medial and then back through the hole from medial to lateral. The suture is swaged onto a straight needle to facilitate this part of the procedure. The toggle button is placed into the loop on the medial surface and retained into position by pulling the loop tight from the lateral side. The button prevents the suture from pulling through. The LigaFiba suture is then tensioned and crimped in the usual way.

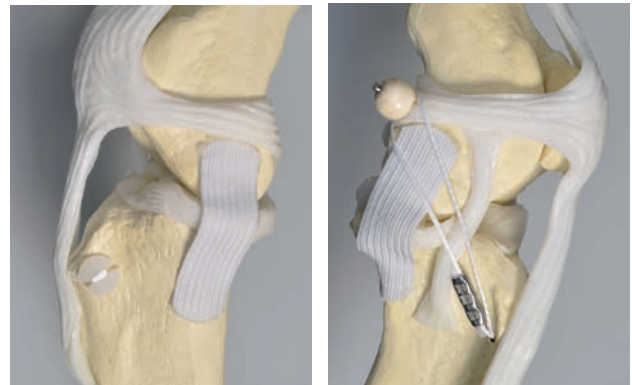

**J0444m 150lb LigaFiba lateral button suture with needles.**

**J0444ma 250lb LigaFiba lateral button suture with needles.**

**J0444mb 500lb LigaFiba lateral button suture with needles.**

**CCL Suture System Starter Kit.**

- J0710sx Deluxe Starter Kit.** Includes:
- Crimping forceps - **J0710xa**
  - 5 pkg. crimp tubes and 80 lb. line, sterile
  - 5 pkg. crimp tubes and 50 lb. line, sterile
  - Bone tunnel borer - **J0236t**
  - Small-eyed graft passer - **J0236se**
  - Procedure instructions on CD-ROM

- J0710sax Starter Kit.** Includes:
- Crimping forceps - **J0710xa**
  - 2 pkg. of **J0710m** 80 lb nylon suture with swaged on needle.
  - 4 pkgs of **J0710p** 100 lb nylon suture with swaged on needle
  - Sterile.
  - Procedure instructions on DE-ROM (**J0710v**)

- J0236se Small-Eyed Graft Passer.** Instrument with handle and thin 3cm radius curved tip with small eye. The small eye will hold the large nylon suture used in cruciate repair. The curved end is used to access tight areas (i.e., between the fabella and femoral condyle). Stainless steel. 6"L. (not pictured)

- J0236t 2.7mm Bone Tunnel Borer.** The borer is a small handle with an attached drill bit. This hand instrument is used to create a bone tunnel quickly and easily without having to set up a complete orthopedic drill (i.e., CCL repair through tibial tuberosity). Stainless steel. 18cm.

- J0236tc 2.7mm Bone Tunnel Borer with Counter Sink.** Same as **J-236t**, with additional counter sink. Counter sink reduces any possible sharp edges left from drilling into tibial crest that could fray nylon line.

- J0710r Tensioning Clamp.** These small stainless steel clamps feature knurled knobs that lock onto the nylon suture. After that, they are attached to a standard Gelpi or Weitlaner retractor and tension applied to the proper level. No need to throw away crimp tubes or purchase expensive tensioning instruments. Pair.

- J0710q Heavy-Duty Needle Driver.** Tungsten carbide jaws. Especially designed to grip cruciate needle and ease passage around tough fabella tissue. 7"L.

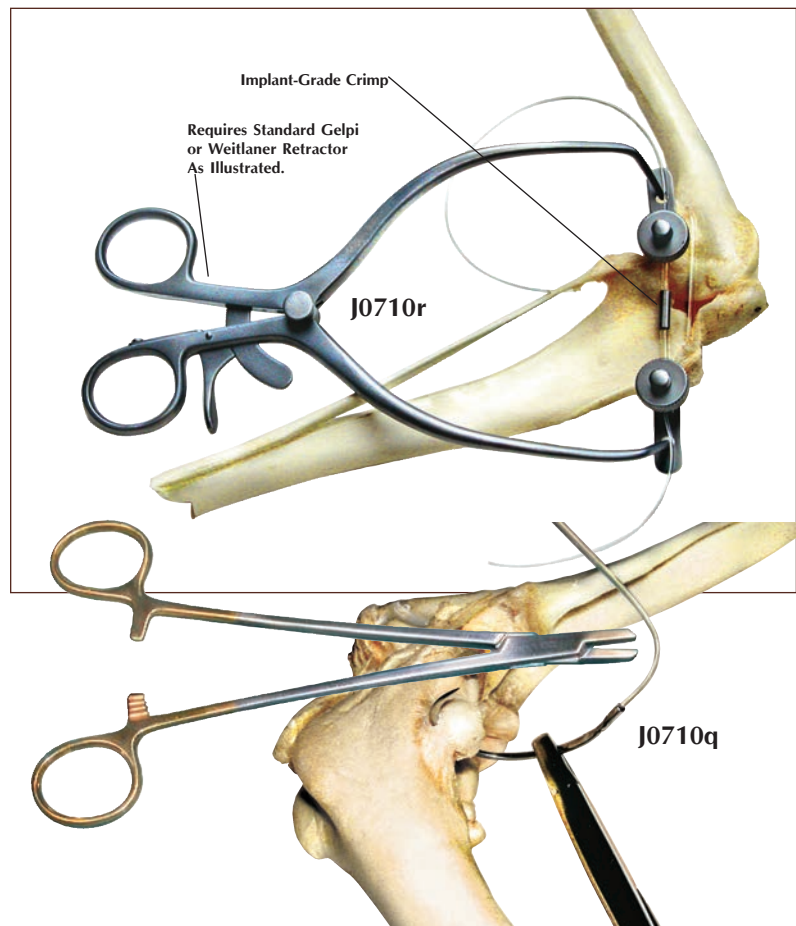
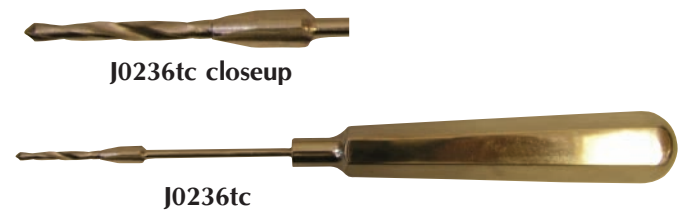
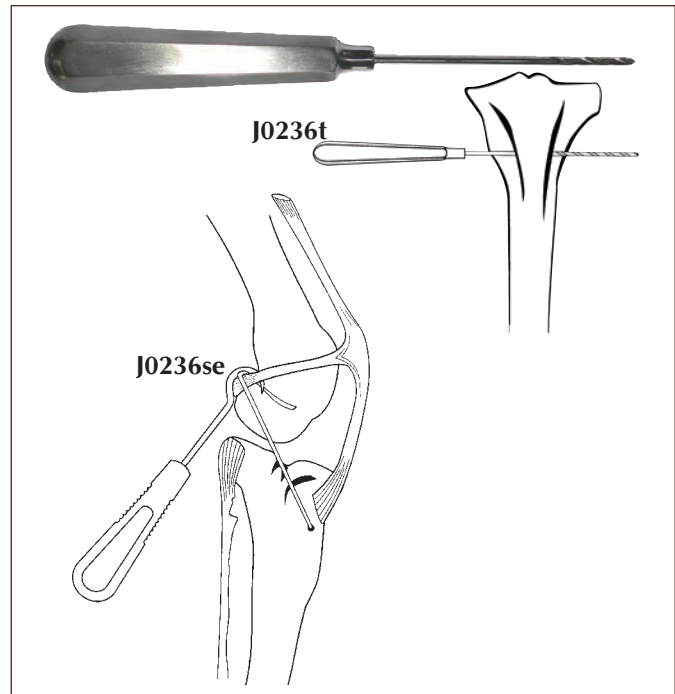

**J0710t Meniscus Surgery Kit.** Failure to manage meniscus injuries can seriously compromise recovery from any cruciate surgery. Identification of meniscus tears are greatly facilitated by a range of specialty instruments including the meniscus probes. A torn meniscus may look normal until examined with a probe.

Meniscus surgery kit includes

- Meniscus probe 1mm tip (**J0710na**)
- Hohman retractor 12mm (**J0235a**)
- Super Mini Hohman retractor 4mm (**J0235ma**)
- Stifle retractor (**J0240wm**)
- Small stifle retractor (**J0240wa**)
- Microtooth meniscus clamp (**J0236h**)
- Microscalpel scalpel handle (**J0890**)
- 5 ea Microscalpel scalpel blade #65 (**J0891a**)
- 5 ea Microscalpel scalpel blade #64 (**J0891**)
- Surgery tray with silicone pegs
- Cloth wrapper for sterilization



J0710t



**J0710n Meniscus Probes.** Visualization of the caudal horns of the meniscus can be a challenge. Often the process of exposing the caudal horn can result in distortions. A normal meniscus can look damaged or a "bucket handle" tear can sit back and look normal. It is helpful to gently probe the meniscus to establish its true condition. Dimensions refer to length of tip. Use 1mm in dogs <30kg and for dogs >30kg use a 2mm.

<b>J0710n</b>	<b>2mm probe</b>	9"
<b>J0710na</b>	<b>1mm probe</b>	7½"

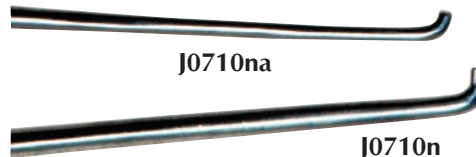

**Femoral Head Disarticulator.** This totally unique instrument is designed to disarticulate the head of the femur from the acetabulum. It is particularly useful in cases of femoral neck fracture and femoral head excision, where manipulation of the femur is difficult. The curved blade slides around and between the head of the femur and acetabulum. The sharpened notch at the tip locates and cuts through the round ligament. The femoral head now can be elevated by the disarticulator and removed. 14 cm (5½").

**J0233 Disarticulator.** Small. Use to engage and sever the round ligament during total head and neck excision. Remember if you cannot see the severed insertion of the round ligament of the femoral head you probably have not completely cut it. 5½".

**J0233b Disarticulator.** Large. 7¾".

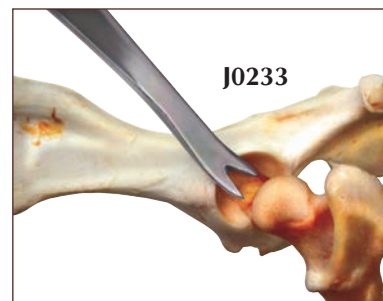



**LigaFiba.** After “fiber” an extremely strong surgical suture material. It is composed entirely of ultra high molecular weight polyethylene. It is the same hard wearing material that is used for acetabular cups in hip replacements. Weight for weight it is 15 times stronger than steel and 2.5 times stronger than nylon. It has very good abrasion characteristics which are important in hostile environments such as lateral sutures and hip toggles.

**LigaFiba braided polyethylene fiber.** Sutures may be threaded through bone tunnels positioned at isometric points. The LigaFiba Iso Toggle systems uses bone tunnels and is described in detail in a separate brochure and CD. Available for viewing at [www.JorVet.com](http://www.JorVet.com).

The isometric points used are as follows:

- Femur: just cranial to and just distal to the lateral fabella close to the caudal border of the femoral condyle. The tunnel is drilled from lateral to medial from the isometric point.
- Tibia: tubercle of Gurdy just cranial to the Long Digital Extensor. The tibial bone tunnel is drilled from lateral to medial from the tubercle of Gurdy. The suture is pulled through the tunnels from the medial tibia and tied over toggle buttons creating a very strong lateral suture between two isometric points.

It is suggested that 250lb LigaFiba is appropriate for dogs less than 50lb and that 500lb LigaFiba is suitable for dogs greater than 50lb. The 250lb LigaFiba is 2.5 times as strong as the heaviest 100lb nylon lateral suture. Use 2.5mm bone tunnels for 250lb and a 3.5mm bone tunnel for 500lb.

**LigaFiba suture material only.** Sterile package.

- J0444a** 150 lb test (0.6mm diameter) x 500mm length
- J0444b** 250 lb test (1.0mm diameter) x 600mm length
- J0444c** 500 lb test (1.6mm diameter) x 600mm length

**LigaFiba lateral suture.** LigaFiba lateral suture with swaged on needles one end has attached cruciate needle for fabella ligament passage. The other end a straight needle for passing through tibial crest. The LigaFiba ties easily but also can be crimped (requires JorVet fiber crimper instrument **J0710xa**) and JorVet fiber crimp **J0448 series**. Sterile package.

- J0444da** 150 lb test, x 500mm length (use **J0448c** crimp tube)
- J0444d** 250 lb test, x 600mm length (use **J0448a** crimp tube)
- J0444e** 500 lb test, x 600mm length (use **J0448b** crimp tube)

- J0710xa** JorVet Compound Action Crimper
- J0372fxL** 3.5mm AntiSkid Drill 180mm
- J0444s** LigaFiba Scissor. LigaFiba is very difficult to cut. This special scissors will give you a clean cut edge.

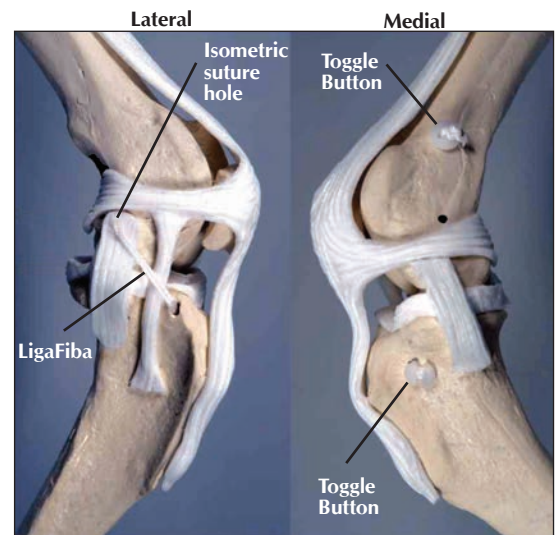
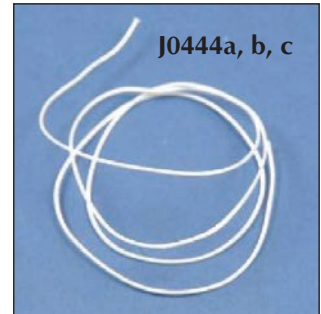

**CAUTION:** As is the case with all braided materials surgeons may have problems with drainage that they did not have with monofilament.

**LigaFiba Crimps.** LigaFiba ties very well, but many surgeons prefer the low profile, security and speed of crimps to complete lateral sutures. Crimps are available for all sizes of LigaFiba. Please note that only the LigaFiba crimper (**J0710xa**) is powerful enough for LigaFiba Crimps.

- J0448c** Crimp Tube for 150lb LigaFiba
- J0448a** Crimp Tube for 250lb LigaFiba
- J0448b** Crimp Tube for 500lb LigaFiba

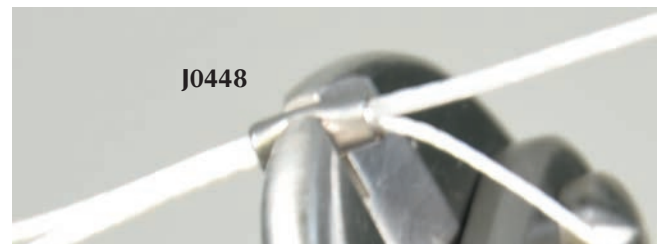

**LigaFiba Iso toggle suture.** A newer technique for extra capsular repair of CCL damage uses a bone tunnel between isometric point on the femur. A set of small toggles are used instead of passage through the fabella ligament. The LigaFiba is passed through the bone tunnel with an attached straight needle.

- If two points, one on the distal femur and one on the proximal tibia are isometric, as the stifle is flexed and extended the distance between the two points remains constant.
- The location points we use for the lateral suture system are not isometric but are very convenient for suture placement. Lack of isometry contributes to early loop failure. Using bone tunnels and the research of Simon Roe (VCOT 2008) we can place a LigaFiba suture across the stifle in an isometric position.

LigaFiba Suture is also available as a hip toggle suture and as sterile pre-cut length for ligament repairs, e.g. collaterals.

- J0444fa** **LigaFiba Iso toggle suture 150 lb test** (dogs up to 25lbs)  
Bone tunnel use **J-372bx** 2.0mm drill.
- J0444f** **LigaFiba Iso toggle suture 250 lb test** (dogs up to 50lbs)  
Bone tunnel use **J-372cx** 2.5mm drill.
- J0444g** **LigaFiba Iso toggle suture 500 lb test** (dogs over 50lbs)  
Bone tunnel use **J-372fx** 3.5mm x 180mm drill.

- J0444k** **IsoToggle Starter Kit includes:**  
  - J-444f** LigaFiba IsoToggle suture 250 lbs (2)
  - J-444g** LigaFiba IsoToggle suture 500 lbs (2)
  - J-372cx** 2.5mm drill x 120mm
  - J-372fxl** 3.5mm drill x 180mm

*Priced so **J-444g** 500lb IsoToggle system is free!*

Step by step guidelines available. The LigaFiba can be readily tied by the toggle button. Toggle buttons also available separately.

**Isotoggle Buttons.** Non sterile. Can be safely autoclaved.

- J0444n** **Toggle Button** large 11mm
- J0444p** **Toggle Button with slots** large 11mm
- J0863x** **Toggle Button** medium 8mm
- J0863y** **Toggle Button with slots** medium 8mm

**LigaFiba Isotoggle Locking Interference Screw.** An alternative to using toggle buttons with LigaFiba is using these interference screws. They give a low profile alternative to tying over a button. The screw has tapered soft profile thread which jams the LigaFiba into the bone tunnel without damaging it. The screw may be partially introduced then the joint checked for stability. If satisfied, the screw is driven to lock the suture. Hex Head.

- J0444v** 3.5mm titanium
- J0444r** 3.5mm stainless
- J0444t** 4.5mm stainless
- J0444u** 4.5mm titanium

**J1143** **Push Pull Suture Passer.** Passing soft suture material such as LigaFiba through bone tunnels can be a challenge likened to pushing a piece of string. The Push Pull suture passer hooks onto suture material and may then either be pushed through a bone tunnel or pulled back through one. Diameter is 2.0mm.

**J0822f** **TPLO Rotation Gauges.** Eleven rotation gauges simplify the TPLO rotation procedure. Correct millimeter measurement readings from the table assists selecting an appropriate gauge. Then mark the bone using the **J0822f** scriber or an osteotome. No more need to work with cumbersome rulers. These 5–15mm gauges are on a handy “key ring.”

**J0232c** **TPLO Caliper Gauge.** Very fine caliper with set screw, for measurement of 0-20mm. German-made. Stainless steel. Used to determine amount of mm rotation of proximal tibia piece in TPLO surgery.

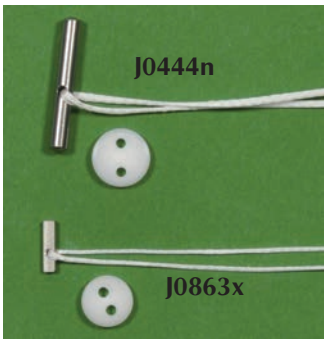
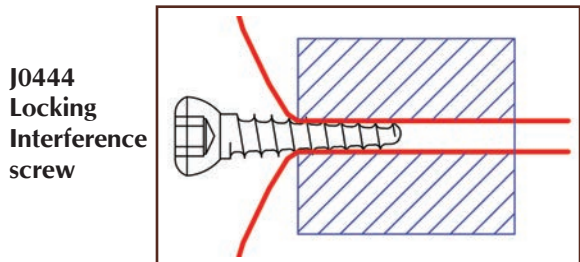
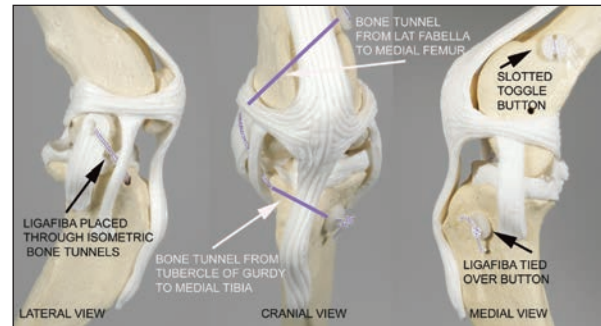
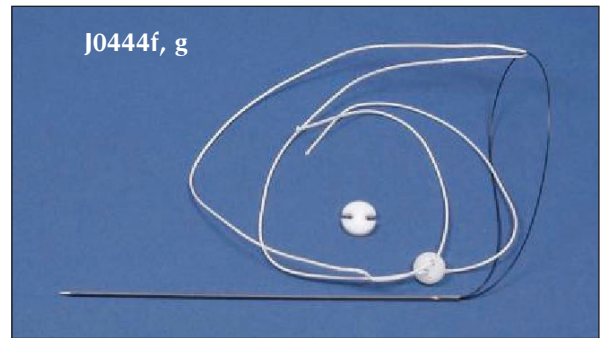

**Standard TPLO Plates.** JorVet version of the original TPLO plates. Made of 316LVM implant grade stainless steel. Milled, not cast.

The JorVet plate has been modified in the head region to make contouring easy while retaining the stiffness of 316LVM elsewhere for stability and rapid healing. The lower profile makes closure easier.

- J0438** TPLO plate 3.5mm left
- J0438a** TPLO plate 3.5mm right
- J0438b** TPLO plate 2.7mm left
- J0438c** TPLO plate 2.7mm right



**Standard TPLO precontoured plates.** Made of 316LVM milled material that is precontoured for easy application.

- J0438ac** TPLO plate 3.5mm precontoured right
- J0438bc** TPLO plate 3.5mm precontoured left
- J0438gp** TPLO Guide Pin. End threaded negative pin. Drive directly into tibia for attachment of TPLO jig 3.2mm (1/8") diameter with 25mm thread lengths. Will work with other brands of TPLO jigs.
- J0438j** TPLO jig.
- J0439** Delta Style TPLO Plates, precontoured. These precontoured triangular TPLO plates keep additional bending to a minimum. Available in a wide range of sizes.
- J0439** 3.5mm standard left
- J0439a** 3.5mm standard right
- J0439b** 2.7mm left
- J0439c** 2.7mm right
- J0439d** 3.5mm broad left
- J0439e** 3.5mm broad right
- J0439f** 2.4mm left
- J0439g** 2.4mm right

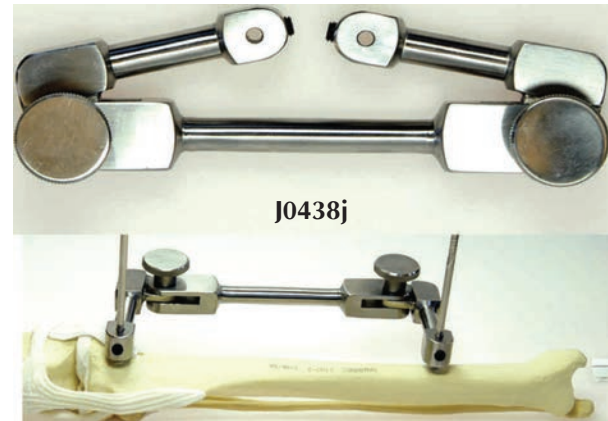

**Mini/small TPLO Plates**

- J0438ma** TPLO plate 2.0mm left
- J0438mb** TPLO plate 2.0mm right
- J0438mc** TPLO plate 2.4mm left
- J0438md** TPLO plate 2.4mm right



**J0438tpc** **Stainless Steel Gauge.** The rotation data for blades 18mm, 21mm, 24mm, 2mm, and 30mm are displayed on this double sided, laser marked, stainless steel gauge. The gauge also incorporates a drill gauge and a ruler for measuring screws and rotation.

For 5 degrees of Tibial Slope			
Tibial Angle	24mm	27mm	30mm
10	2.00	2.50	2.75
11	2.50	3.00	3.25
12	3.00	3.50	3.75
13	3.50	4.00	4.25
14	3.75	4.50	4.75
15	4.25	5.00	5.50
16	4.50	5.50	5.75
17	5.00	5.75	6.25
18	5.50	6.25	6.75
19	6.00	6.75	7.50
20	6.25	7.25	8.00
21	6.75	7.75	8.50
22	7.00	8.25	9.00
23	7.50	8.75	9.50
24	8.00	9.25	10.00
25	8.25	9.75	10.50
26	8.75	10.25	11.00
27	9.00	10.75	11.50
28	9.50	11.25	12.25
29	10.00	11.75	12.75
30	10.25	12.25	13.25
31	10.75	12.75	13.75
32	11.00	13.25	14.25
33	11.50	13.75	14.75
34	12.00	14.25	15.25
35	12.25	14.75	16.00
36	12.75	15.25	16.50
37	13.00	15.75	17.00
38	13.50	16.25	17.50
39	14.00	16.75	18.00
40	14.25	17.25	18.50
41	15.00	17.75	19.00
42	15.50	18.25	19.50
43	16.00	18.75	20.00
44	16.50	19.00	20.50
45	16.75	19.50	21.25

J0438tpc



**Locking TPLO Plates.** The three screws in the head of the standard TPLO locking plate are concentrated into a relatively small area. The screws of the locking TPLO plate are more widely spread out along the osteotomy offering better support of the proximal tibial segment. The two outlying screws converge and the central screw angles into a different plane for maximum resistance. The osteotomy based plate means that the osteotomy may be place high relative to standard locking TPLO plates.

Available in 3.5 broad, 3.5 narrow and 2.7mm. Plates are pre-contoured.

- J0438aLa** 2.7mm Locking TPLO Left
- J0438aLb** 2.7mm Locking TPLO Right
- J0438aL** 3.5mm Locking TPLO Left
- J0438bL** 3.5mm Locking TPLO Right
- J0438aLc** 3.5mm Broad Locking TPLO Left
- J0438aLd** 3.5mm Broad Locking TPLO Right

**Locking screws 3.5mm** (uses 2.7 mm pilot drill bit)

- |                     |                     |
|---------------------|---------------------|
| <b>J0438Ld</b> 18mm | <b>J0438Lm</b> 32mm |
| <b>J0438Le</b> 20mm | <b>J0438Ln</b> 34mm |
| <b>J0438Lf</b> 22mm | <b>J0438Lp</b> 36mm |
| <b>J0438Lg</b> 24mm | <b>J0438Lq</b> 38mm |
| <b>J0438Lh</b> 26mm | <b>J0438Lr</b> 40mm |
| <b>J0438Lj</b> 28mm |                     |
| <b>J0438Lk</b> 30mm |                     |

**J0438dg** **Locking screw drill guide.** The locking screw requires precise drilling to match threaded screw head to plate. It is essential to screw the guide into the plate prior to drilling the pilot hole.

**J0438p** **Locking plug.** Used to protect locking holes while contouring plate (not pictured). Holes 4, 5, and 6 are for locking screws. Holes 1, 2 and 3 are for standard cortical screws.

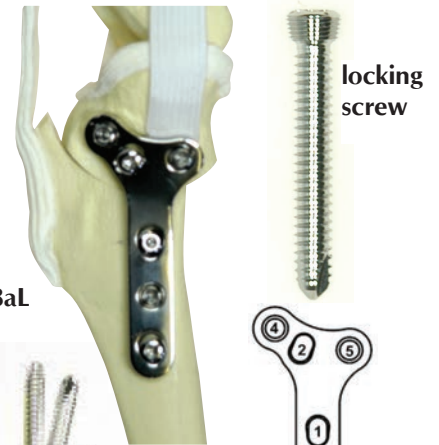

**TPLO Wire Guide and Reduction Forceps.** Once the osteotomy has been performed and the proximal segment rotated it is essential that the construct is stabilised prior to plate application. As is often the case the ideal position for the initial, temporary, stabilisation and the semi-permanent wire are one and the same. The new TPLO reduction forceps are designed to stabilise and compress across the osteotomy site. At the tip is a wire guide tube which allows a stabilising wire to be driven across the osteotomy at exactly the correct position without skidding or slippage at start up. The action is spinlock allowing the surgeon full flexibility on positioning and compression. The forceps are handed and significantly cheaper when purchased as a set.

- J1272** **TPLO Wire Guide and Reduction Forceps** Right 215mm
- J1272a** **TPLO Wire Guide and Reduction Forceps** Left 215mm
- J1272s** **TPLO Wire Guide and Reduction Forceps Set**

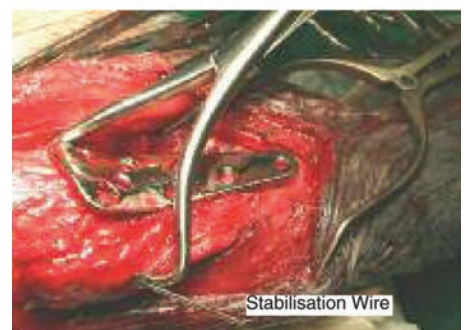

**Osteophyte Rasp.** Most stifles requiring cruciate repair will exhibit some osteophytes. In some cases they may become very bulky necessitating removal. The osteophyte rasp is a small yet very effective rasp to keep in the cruciate set.

- J0209r** **Osteophyte Rasp**



**TTA (Tibial Tuberosity Advancement).** TTA is preferred by some surgeons. Further details on the actual surgery can be seen on [www.JorVet.com](http://www.JorVet.com) or the instructional DVD provided. This system is available in either titanium or stainless steel; titanium is more expensive but offers better biocompatibility and fatigue strength.



**TTA Instrumentation**

J1072a	1.8mm Drill Bit Hard
J1072b	TTA Plate Bender
J1072c	TTA Drill Guide
J1072d	1.9mm pins (set of 2)
J1072e	TTA Fork Holder
J1072f	TTA Spreader with 6, 9 & 12mm inserts
J0412ch	TTA 2.4 Cross Head Screwdriver (Titanium kit only)
J0412b	Hex S'driver for 2.7 and 3.5mm screws
J0410	Depth Gauge for 2.4, 2.7 & 3.5mm screws
J0212m	Small fragment forceps 13.5cm (2 per kit)
J0372bh	2.0mm Drill Bit Hard
J0372ch	2.5mm Drill Bit Hard
J1072g	Combined Drill, Tap & Insert Sleeve for 2.7mm screws
J1072h	Combined Drill, Tap & Insert Sleeve for 3.5mm screws
J1072pfo	TTA Plate and Fork Overlay

**TTA Cages, Plates & Forks**

Titanium	Stainless Steel	Description
J1072jat	J1072ja	Cage 6 x 16mm
J1072jbt	J1072jb	Cage 6 x 19mm
J1072jct	J1072jc	Cage 6 x 22mm
J1072kat	J1072ka	Cage 9 x 19mm
J1072kbt	J1072kb	Cage 9 x 22mm
J1072kct	J1072kc	Cage 9 x 25mm
J1072mat	J1072ma	Cage 12 x 22mm
J1072mbt	J1072mb	Cage 12 x 25mm
J1072mct	J1072mc	Cage 12 x 28mm
J1072nat	J1072na	Plate 3 hole x 42mm
J1072nbt	J1072nb	Plate 4 hole x 52mm
J1072nct	J1072nc	Plate 5 hole x 65mm
J1072ndt	J1072nd	Plate 6 hole x 78mm
J1072net	J1072ne	Plate 7 hole x 91mm
J1072nft	J1072nf	Plate 8 hole x 104mm
J1072pat	J1072pa	Fork 3 prong
J1072pbt	J1072pb	Fork 4 prong
J1072pct	J1072pc	Fork 5 prong
J1072pdt	J1072pd	Fork 6 prong
J1072pet	J1072pe	Fork 7 prong
J1072pft	J1072pf	Fork 8 prong

**2.4mm screws.** Uses 1.8mm pilot drill. Titanium screws have cruciate head. Stainless screws have small hex (same as 2.0mm)

Titanium	Stainless Steel	Description
J1073at	J1073a	2.4 self-tapping Cortical 10mm
J1073bt	J1073b	2.4 self-tapping Cortical 12mm
J1073ct	J1073c	2.4 self-tapping Cortical 14mm
J1073dt	J1073d	2.4 self-tapping Cortical 16mm
J1073et	J1073e	2.4 self-tapping Cortical 18mm
J1073ft	J1073f	2.4 self-tapping Cortical 20mm
J1073gt	J1073g	2.4 self-tapping Cortical 22mm
J1073ht	J1073h	2.4 self-tapping Cortical 24mm
J1073it	J1073i	2.4 self-tapping Cortical 26mm
J1073jt	J1073j	2.4 self-tapping Cortical 28mm
J1073kt	J1073k	2.4 self-tapping Cortical 30mm
J1073Lt	J1073L	2.4 self-tapping Cortical 32mm
J1073mt	J1073m	2.4 self-tapping Cortical 34mm
J1073nt	J1073n	2.4 self-tapping Cortical 36mm
J1073pt	J1073p	2.4 self-tapping Cortical 38mm
J1073qt	J1073q	2.4 self-tapping Cortical 40mm

**2.7mm screws** hex head 2.0mm pilot

Titanium	Stainless Steel	Description
J1072et	J0419es	2.7 self-tapping Cortical 14mm
J1072ft	J0419fs	2.7 self-tapping Cortical 16mm
J1072gt	J0419gs	2.7 self-tapping Cortical 18mm
J1072ht	J0419hs	2.7 self-tapping Cortical 20mm
J1072it	J0419is	2.7 self-tapping Cortical 22mm
J1072jt	J0419js	2.7 self-tapping Cortical 24mm
J1072kt	J0419ks	2.7 self-tapping Cortical 26mm

**3.5mm screws** hex head 2.5mm pilot

Titanium	Stainless Steel	Description
J1074at	J0421ds	3.5 self-tapping Cortical 16mm
J1074bt	J0421es	3.5 self-tapping Cortical 18mm
J1074ct	J0421fs	3.5 self-tapping Cortical 20mm
J1074dt	J0421gs	3.5 self-tapping Cortical 22mm
J1074et	J0421hs	3.5 self-tapping Cortical 24mm
J1074ft	J0421is	3.5 self-tapping Cortical 26mm
J1074gt	J0421js	3.5 self-tapping Cortical 28mm
J1074ht	J0421ks	3.5 self-tapping Cortical 30mm

**Boxes for TTA screws and equipment**

J1072sb	TTA Screwbox for 2.4, 2.7 & 3.5 screws
J1072q	Stainless Case for TTA equipment
J1072r	Silicone Insert for TTA Equipment Case

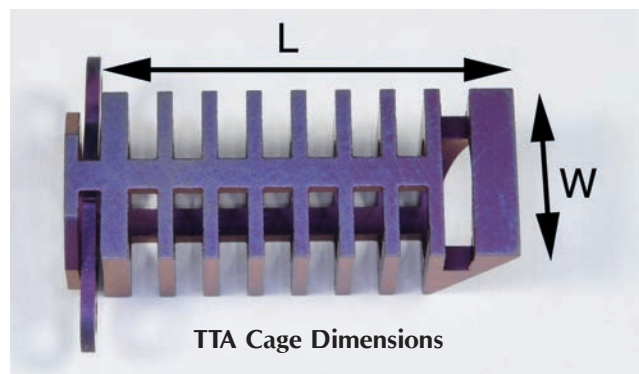

**Cuttable Cages.** As additional sizes of cages become available it is becoming increasingly difficult to manage and store the full inventory of cages. The expense of keeping the current 24 cage sizes in stock is considerable. Use of cuttable cages means that less cages need to be stocked (particularly the short uncommon sizes), cage length can be adjusted quickly and easily for each patient during the procedure. Cages may be trimmed by 2mm increments using the dedicated cutters..

- J1072gatc **Cuttable TTA Cage Titanium 3mm x 16mm**
- J1072hctc **Cuttable TTA Cage Titanium 4.5mm x 18mm**
- J1072jbtc **Cuttable TTA Cage Titanium 6mm x 22mm**
- J1072Lctc **Cuttable TTA Cage Titanium 7.5mm x 22mm**
- J1072kctc **Cuttable TTA Cage Titanium 9mm x 26mm**
- J1072rctc **Cuttable TTA Cage Titanium 10.5mm x 26mm**
- J1072mctc **Cuttable TTA Cage Titanium 12mm x 28mm**
- J1072sctc **Cuttable TTA Cage Titanium 15mm x 32mm**



Cuttable Cages

J1072xz **Cuttable TTA Compound Cutters.**

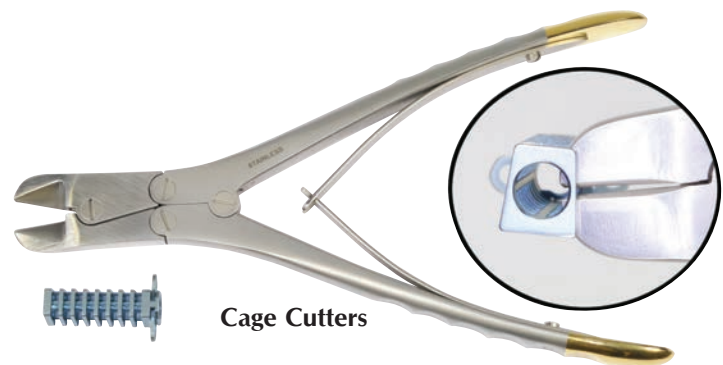

Cage Cutters

**Spacers.** Where there is concurrent CrCL failure and patella sub luxation. It is possible to adjust the quadriceps mechanism by moving the tibial tubercle laterally or medially. Titanium washers may be used but the dedicated TTA spacer has a larger footprint, a better interlock with the cage and are available in a range of preset widths.

- J1072xh **10.5mm Spacer**
- J1072xj **12mm Spacer**
- J1072xk **15mm Spacer**
- J1072xL **3mm Spacer**
- J1072xm **4.5mm Spacer**
- J1072xn **6mm Spacer**
- J1072xz **7.5mm Spacer**

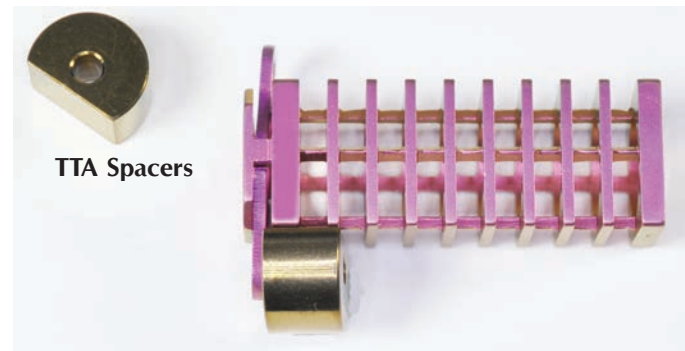

TTA Spacers

**TTA Washers.** The standard TTA procedure assumes that there is no co-existing patella issues. The tibial tubercle is simply advanced. In cases where there is patella luxation in addition to cranial cruciate rupture, it is possible to move the tibial tubercle either laterally or medially to help re-align the quadriceps mechanism. this is achieved by adding washers to either the cranial screw or the caudal cage screw. The washers are placed between the cage and the tibia to effectively push the tibial tubercle laterally (cranial screw) or push the tibial tubercle medially (caudal screw). It is suggested that the tibial tubercle is moved a maximum of 50% of its width.

Each washer adds 1.0mm of translation.

J1072w **TTA Washer Titanium.**

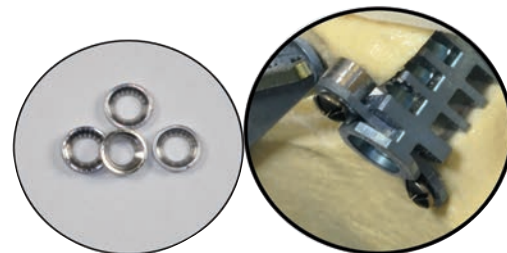

J1072w TTA washers



**TTA Instrument and Implant Case.** The TTA Kit comprises three different screw sizes, at least seven plate and fork sizes, five cage sizes plus a wide selection of instruments. Our TTA case has locations for all implants and all instruments in one premium case. The case will house all TTA equipment regardless of manufacturer.

- J1073fp** **TTA Cage Forceps**
- J1072q** **TTA Implant and Equipment Case only.** Stainless Steel. (Does not include inserts case and 3 inserts - **J1072qc**)

**TTA Instrument Kits** Includes all relevant instruments listed above in a stainless steel case.

- J1072tk** **TTA Instrument Case and Instruments, Titanium.**
- J1072k** **TTA Instrument Case and Instruments, Stainless Steel.**

**TTA Complete Instrument and Implant Kits** Kit contains all the TTA instruments listed plus two of each implant. Instruments supplied in a free stainless autoclave case.\*

- J1072t** **Titanium.** High biocompatibility, fast healing
- J1072** **Stainless Steel.** Great value

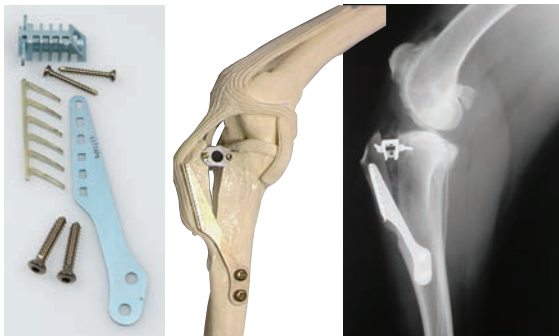

**J1072QC**  
\*This case is for display only or available separately.

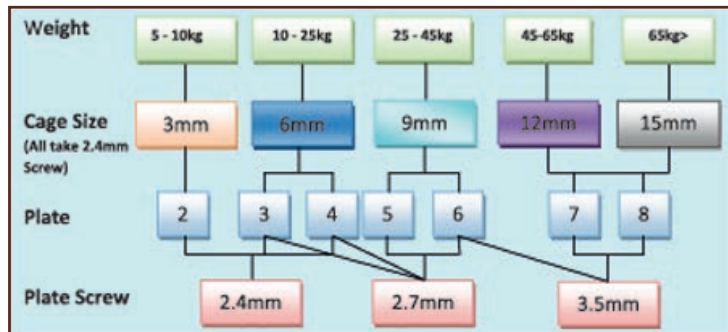

**J0822s** **Wedge Osteotomy Gauge Set.** These 14 wedge gauges (8–22°) simplify marking and cutting of an appropriate wedge. Parallel marks on each gauge allow the surgeon to mark and cut a wedge having equal proximal and distal borders. Borders the same length result in a better closure both functionally and cosmetically.

**J0822t** **Bone Scriber.** A very sharp marking point with an easy-to-hold handle enables marking bones prior to cutting or rotating.

**J1073fp** **TTA Cage Forceps.** This forcep is very useful when doing a TA cruciate repair for grasping the small TTA cage as it is inserted into the tibial crest osteotomy in a very tight fit. The forceps can grasp the cage firmly along its spine while stiff in the storage case.

**J0436g** **TTA Saw Guide.** Creating the TTA osteotomy freehand is something of a challenge. The position and plane of the saw cut are critical to the rest of the procedure. The TTA saw guide is a useful assistant to the surgeon in that the guide may be positioned securely in the correct place so the surgeon can concentrate on the saw without having to constantly worry about the cut.

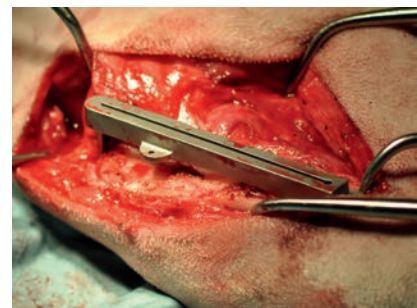
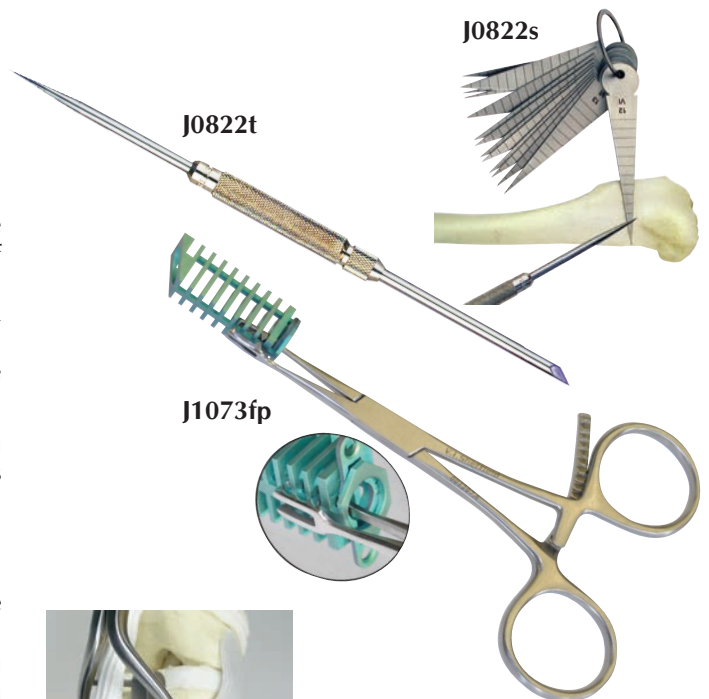

**Forkless TTA Plate.** Standard TTA plates rely on a barbed for system for attachment onto the tibial crest. Many surgeons consider that the hardest part of the TTA procedure is preparing for and placing the fork. Forkless TTA plates are screwed onto the tibial crest using 2.4 screws. The distal part of the forkless plate is secured using 2.7 or 3.5mm screws as appropriate. The rest of the procedure is as per the standard technique..

- J1072tf3 Forkless TTA Plate.** 42mm
- J1072tf4 Forkless TTA Plate.** 52mm
- J1072tf5 Forkless TTA Plate.** 65mm
- J1072tf6 Forkless TTA Plate.** 78mm
- J1072tf7 Forkless TTA Plate.** 91mm
- J1072tf8 Forkless TTA Plate.** 104mm



**J1072tf**

**J1218a Plate Holding and Drill Guide Forceps** are very useful during the positioning and drilling of the pilot holes

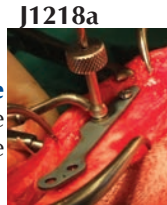

**J1218a**

**The Modified Maquet Technique (MMT)**

The Modified Maquet Technique(MMT) is a variation on the TTA and TTO techniques of cruciate management in that it aims to bring the tibial plateau to sit at right angles to the straight patella ligament. By creating an incomplete tibial crest osteotomy the placement of a TTA advancement cage alone creates sufficient post operative stability for rapid healing to occur. The technique preserves soft tissue, requires a minimum of implants and saves time and morbidity. The Maquet technique is described in man as a technique to reduce patellofemoral pressure. The MMT technique described here is that presented by Sebastien Etchepareborde to ECVS in 2010 and published in VCOT 2011.3. *Please see the actual procedure and all instructions at [www.JorVet.com](http://www.JorVet.com)*



**TTA Plates and Cages Titanium**

- J1072gat** Cage 3 x 10mm titanium 2.4mm screw
- J1072gbt** Cage 3 x 13mm titanium 2.4mm screw
- J1072gct** Cage 3 x 16mm titanium 2.4mm screw
- J1072hat** Cage 4.5 x 12mm titanium 2.4mm screw
- J1072hbt** Cage 4.5 x 15mm titanium 2.4mm screw
- J1072hct** Cage 4.5 x 18mm titanium 2.4mm screw
- J1072jat** Cage 6 x 16mm titanium 2.4mm screw
- J1072jbt** Cage 6 x 19mm titanium 2.4mm screw
- J1072jct** Cage 6 x 22mm titanium 2.4mm screw
- J1072Lat** Cage 7.5 x 13mm titanium 2.4mm screw
- J1072Lbt** Cage 7.5 x 16mm titanium 2.4mm screw
- J1072Lct** Cage 7.5 x 19mm titanium 2.4mm screw
- J1072kat** Cage 9 x 19mm titanium 2.4mm screw
- J1072kbt** Cage 9 x 22mm titanium 2.4mm screw
- J1072kct** Cage 9 x 25mm titanium 2.4mm screw
- J1072rat** Cage 10.5 x 19mm titanium 2.4mm screw
- J1072rbt** Cage 10.5 x 22mm titanium 2.4mm screw
- J1072rct** Cage 10.5 x 25mm titanium 2.4mm screw
- J1072mat** Cage 12 x 22mm titanium 2.4mm screw
- J1072mbt** Cage 12 x 25mm titanium 2.4mm screw
- J1072mct** Cage 12 x 28mm titanium 2.4mm screw
- J1072sat** Cage 15 x 25mm titanium 2.4mm screw
- J1072sbt** Cage 15 x 28mm titanium 2.4mm screw
- J1072sct** Cage 15 x 31mm titanium 2.4mm screw

**TTA Spinlock Reduction Forceps.** Regardless of the style of plate preferred it is desirable to compress the distal part of the osteotomised tibial tubercle against the tibial shaft while applying the plate. This will increase stability of the repair and reduce healing times. ‘Soft ratchet’ type forceps are very nice but very expensive and prone to wear. The spinlock reduction forceps are the right size and have the correct degree of spread for most TTA procedures.



Also useful as a fracture reduction forceps in trauma orthopedics.

**J0212kL TTA Spinlock Reduction Forceps.** (180mm)

**Titanium Screws 2.4mm Cruciate Head 1mm Pilot**

- J1073at** Titanium 2.4mm Self Tapping Screw 10mm
- J1073bt** Titanium 2.4mm Self Tapping Screw 12mm
- J1073ct** Titanium 2.4mm Self Tapping Screw 14mm
- J1073dt** Titanium 2.4mm Self Tapping Screw 16mm
- J1073et** Titanium 2.4mm Self Tapping Screw 18mm
- J1073ft** Titanium 2.4mm Self Tapping Screw 20mm
- J1073gt** Titanium 2.4mm Self Tapping Screw 22mm
- J1073ht** Titanium 2.4mm Self Tapping Screw 24mm
- J1073it** Titanium 2.4mm Self Tapping Screw 26mm
- J1073jt** Titanium 2.4mm Self Tapping Screw 28mm
- J1073kt** Titanium 2.4mm Self Tapping Screw 30mm
- J1073Lt** Titanium 2.4mm Self Tapping Screw 32mm
- J1073mt** Titanium 2.4mm Self Tapping Screw 34mm
- J1073nt** Titanium 2.4mm Self Tapping Screw 36mm
- J1073pt** Titanium 2.4mm Self Tapping Screw 38mm
- J1073qt** Titanium 2.4mm Self Tapping Screw 40mm

**MMT Instrumentation**

- J0412ch** 2.4 Screwdriver (crosshead)
- J1072a** 1.8mm Pilot Drill for 2.4 screw
- J0372fx** 3.5mm Drill for hinge hole
- J0226s** Periosteal Elevator 6mm AO Type 180mm
- J0226q** Freer Periosteal Elevator
- J1072f** TTA Spreader and 3, 6, 9, 12 & 15mm Inserts
- J0866k** MultiSaw Surgical Kit
- J0436h** MMT Saw Guide
- J0436w** ‘Wedgie’ Osteotomy Spreader
- J1073fp** TTA Cage Forceps
- J0410** Depth Gauge for 2.4mm
- J1072pfo** Traditional TTA/MMT Advancement Overlay
- J1072pao** Common Targent TTA/MMT Advancement Overlay

- Complete surgery overview at [www.JorVet.com](http://www.JorVet.com)
- Uses TTA titanium cage as seen on page 237 and 238
- Uses titanium 2.4mm screws

Other suggested equipment for MMT

- J0372fx** 3.5mm drill bit for hinge hole
- J0866kmr** Multimaster saw kit
- J0436h** MMT saw guide
- J1073ep** TTA cage forceps

**Stifle Retractor.** The examination of the meniscus and intra-articular structure during anterior cruciate repair is a real necessity. This visualization often is difficult even in the largest of dogs. The stifle retractor allows gentle retraction between the femur and tibia, exposing the entire stifle joint to a thorough exam without damaging the joint surface. Stainless steel.

**J0240wm Modified Stifle Retractor.** 7<sup>1</sup>/<sub>2</sub>". Designed for medium and large dogs (the group with the highest incidence of meniscal damage), this improved model has longer jaw tips which are self protecting when the instrument is in the closed position. Once inserted atraumatically into the stifle, distraction exposes the longer tips for maximum grip. The best instrument to examine the caudal horn of the medial meniscus. (15-50 Kg)

**J0240wa Small Stifle/Joint Retractor.** 5" length. 6mm profile. The small overlapping tips allow atraumatic entry into small arthrotomies and small stifles. (5-50 Kg)

**J0240wb X-Small Joint Retractor.** 5" length. Tips differ by the smaller 3mm versus 6mm profile of J-240wa. (<50 Kg)

**J0240ws Wallace Stifle Retractor.** 5" length.

**J0240 Spinlock stifle distractor.** The working tips or our spinlock are the same as the ratchet version. The spinlock offers more secure distraction as it is less likely to slip. The spinlock also offers an infinite range of position versus the ratchet.

**J0240was** small stifle retractor spinlock.  
**J0240wbs** x-small stifle retractor spinlock.

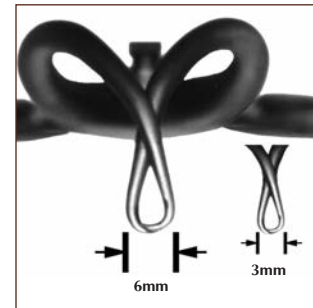
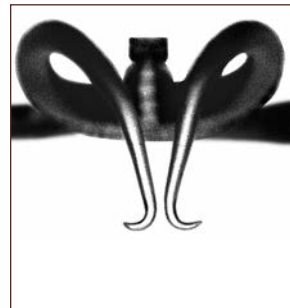

J0240wa

J0240wb



Jaws Closed

Jaws Slightly Open

J0240wa



J0240was and J0240wbs



**Miniature Stifle Distractor.** Although the tips on our very small stifle distractor are very small, the rest of the instrument remains too bulky for very small and miniature dogs. The miniature stifle retractor has been scaled down all round making it ideal for smaller breeds. Small breeds get meniscal injuries too. As is the case with all our stifle distractors, the retaining tips are overlapping creating a low profile, atraumatic entry into the joint.

**J0240q Miniature Stifle Distractor.** 100mm.



J0240q



**External Stifle Distractor.** Osteoarthritic stifles can be very tight making examination and treatment of meniscal lesions difficult. Distraction of the articular surfaces using intra-articular instruments clutters the operative field. Originally developed for arthroscopic use, the extra articular distractor works very well in open surgery.

Pins are placed above and below the stifle approximately along the line of the medial collateral ligament. The standard distractor uses 2.5mm pins. For those TPLO surgeons who wish to use the proximal tibial pin as their proximal jig pin, a version is available which takes 3.2mm (1/8") pins. Turning the thumb screw distracts the joint from the medial side exposing the medial meniscus. For better view of the caudal horn, the pins may be twisted relative to each other which brings the tibial plateau forward.

**J0240x External stifle distractor** 2.5mm pins

**J0240xa External stifle distractor** 3.2mm pins

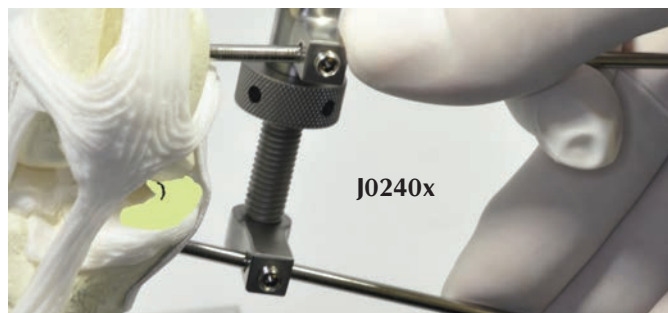

**Cruciate Staples.** Spikes under the head trap the autografts. Barbs on the legs prevent pull out.

Cruciate staples provide very secure fixation of fascial autografts behind the femoral condyle. Any mallet can be used to drive the staple into the bone.

*NOTE: Dimension is width under head.*

**J0838 Staple Introducer.** Jaws of staple introducer engage grooves in head of staple giving a very firm grip allowing accurate staple placement.

**J0838a Staple.** 6mm W.

**J0838b Staple.** 8mm W.

**J0838c Staple.** 11mm W.

**J0838d Staple.** 16mm W.

**J0838k CCL Staple Kit in Stainless Steel Box.** Includes introducer plus 8 staples.



**J0838 Series**

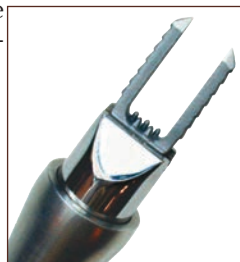

**Stainless Steel Goniometers.** For pre-operative planning or postop physiotherapy our plastic goniometers are fine. However, for intra operative use a more robust autoclavable version is desirable.

**J0752x Goniometer** 340mm stainless

**J0752y Femoral neck/head goniometer** 120mm

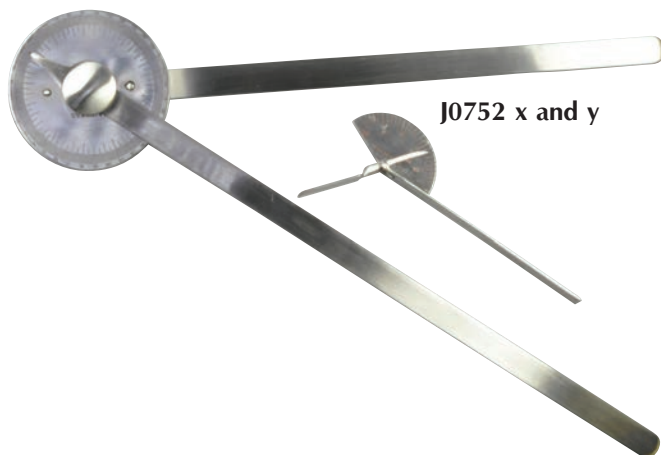

**J0752 x and y**



J0236m

**J0236m Meniscus Knife.** A specially-designed knife for use in the limited space of the canine stifle. 15cm.



J0235

**Hohman Retractor** greatly improve exposure and access in the small surgical field of joint surgery. Stainless steel.



J0235ma

**J0235a Hohman Retractor.** 12mm W x 24cm L (9"). Medium breeds.

**J0235b Hohman Retractor.** 18mm W x 24cm L (9 1/2"). Large breeds.

**J0235m Mini Hohman Retractor.** 6 1/4" with narrow 6mm blade.

**J0235ma Super Mini Hohman retractor.** 4mm tips. Developed for use with miniature breeds and cats. 6 1/2" (170mm) length.

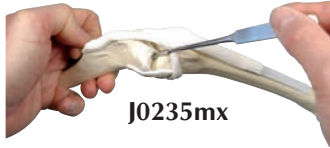

J0235mx

**J0235mx 4mm Micro Hohman arthroscopic style.** The micro 4mm blade is attached to a slender shaft which may be introduced arthroscopically through instrument portals for manipulation of intra-articular structures.



**Hip Hohman.** Originally developed as a Hohman specifically for Total Hip Replacement (THR) this style has proved useful in elevating the head of the femur for other hip procedures including toggling and total head and neck excision (THNE). The multiple small teeth at the tip set securely on the femoral neck outside the zone of articular cartilage.

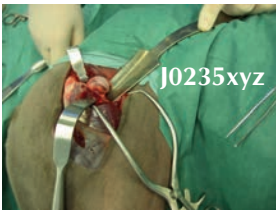

J0235xyz

J0235s

**J0235x Hip Hohman - Large.** 255mm x 25mm x 36mm blade.

**J0235y Hip Hohman - Medium.** 175mm x 13mm x 18mm blade.

**J0235z Hip Hohman - Small.** 125mm x 8mm x 12mm blade.

**Stifle Lever.** Examination and management of meniscal injuries is made extremely difficult by the limited access to the medial meniscus during routine approaches. Exposure of the medial meniscus is typically achieved by either use of a stifle distractor or by a Hohman retractor. Hohman retractors are not designed for levering against articular cartilage in that the blade does not "fit" the trochlea. The stifle lever is designed to substitute the Hohman. The caudal surface of the stifle lever is contoured to fit the trochlea of large dogs. The load is dissipated over a large area minimising trauma. The ring style handle is convenient for retraction by the surgeon using the thumb. The tip atraumatically hooks behind the caudal aspect of the tibial plateau. 9" (225mm) length.

**J0235sa small stifle lever.** The original stifle lever (J-235S) was designed for use in large and medium dogs 30-100lbs. This smaller lever is suitable for dogs 10-35lb. The caudal aspect is designed to fit the femoral trochlear groove without causing damage. 6 1/2" (170mm).

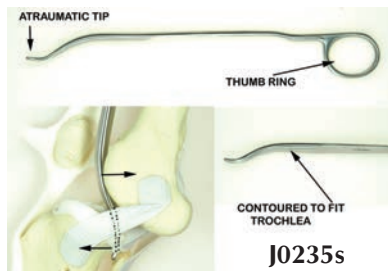

J0235s

**J0236c Ligament Meniscus Clamp.** Specially designed clamp used for clamping and removing torn meniscus pieces. Intra-articular structures are very difficult to grip in the presence of synovial fluid. The micro-serrations on this clamp make the task easier.



**Curved Graft Passer.** Used in anterior cruciate repairs such as the "over the top procedure." Using the Graft Passer lessens the risk of damage to joint surfaces and ancillary structures. Stainless steel.

**J0236xs Curved Graft Passer.** X-Small. 2.0cm dia. head.

**J0236s Curved Graft Passer.** Small. 3.0cm dia. head. 15cm L.

**J0236 Curved Graft Passer.** Large. 4.5cm dia. head. 17cm L.

**J0236L Curved Graft Passer.** X-Large. 6.0cm dia. head.

**J0236xL Curved Graft Passer.** XX-Large. 8.0cm dia. head.

**J0236h Micro-toothed meniscus clamp.** Management of meniscal injuries is very important. In medium and small dogs space limits access. The toothed mini-meniscus forceps are designed to grasp damaged meniscus tissue to facilitate removal using micro blades.

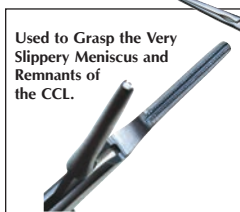

Used to Grasp the Very Slippery Meniscus and Remnants of the CCL.

J0236c



J0236

Slot Cut Into Head



J0236h



J0375

**Stainless Steel Spike Washer.** Used for ligament attachment or fixation to spread load or retain wire or sutures. Autoclavable.

**J0375wc Spike Washer** for use with 2.7mm screw.

**J0375wd Spike Washer** for use with 3.5mm screw.

**J0375we Spike Washer** for use with 4.5mm screw.

**Arthroscopy Hand Instrument Set.** Useful set of three arthroscopy instruments for examination and intra-articular surgery. The two hand held knives can deal with most meniscal tears. The black shaft of the hook probe minimizes reflection.

- J0444x** **Meniscus Push Knife**
- J0444y** **Meniscus Pull (hook) Knife** 4mm
- J0444ys** **Smaller meniscus pull (hook) knife** 3mm
- J0444z** **Hook Probe** 2.2mm with stainless handle, black shaft
- J0444w** **Set of all 3 instruments**

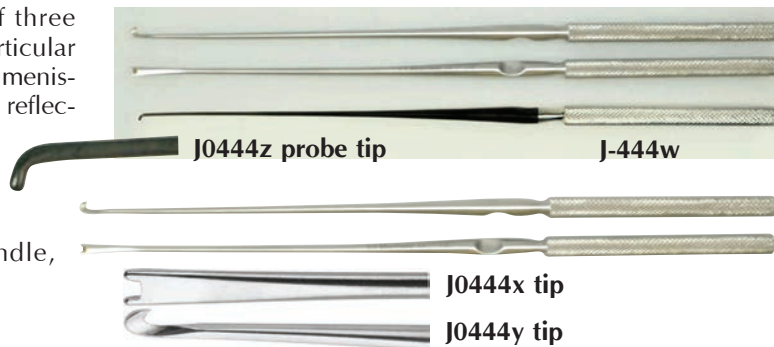

**J0444q** **Vetura Stifle Thrust Lever.** Exposure of the medial meniscus for examination and treatment is never easy. Many instruments have been developed for the purpose. The original technique required a Hohman to advance the tibia. Standard Hohmans are not designed for the purpose and can cause trauma to both tibia and trochlea. The original stifle lever addresses these issues but is a little bulky for arthroscopic use. The arthroscopic version is finer, longer, and has a substantial Teflon handle allowing better manipulation of the joint.



**Suture Screw.** Suture anchors have many uses, particularly reattachment of a ligament to bone. A screw is placed into bone and the head of the screw has an eyelet for suture placement. The screws are self-tapping after placement of a smaller pilot hole. A special driver is used to insert the screw. Suggested uses include: • Coxo femoral luxations • Shearing injuries • Collateral ligament repairs • Anchor for CCL lateral sutures

<b>J0836d</b>	<b>Cortical Screw.</b>	2.0mm.	6mm L.	1.0mm eyelet dia.	1.5mm pilot hole.
<b>J0836</b>	<b>Cortical Screw.</b>	2.0mm.	10mm L.	1.0mm eyelet dia.	1.5mm pilot hole.
<b>J0836e</b>	<b>Cortical Screw.</b>	2.7mm.	8mm L.	1.5mm eyelet dia.	2.0mm pilot hole.
<b>J0836a</b>	<b>Cortical Screw.</b>	2.7mm.	14mm L.	1.5mm eyelet dia.	2.0mm pilot hole.
<b>J0836f</b>	<b>Cortical Screw.</b>	3.5mm.	12mm L.	2.0mm eyelet dia.	2.5mm pilot hole.
<b>J0836b</b>	<b>Cortical Screw.</b>	3.5mm.	20mm L.	2.0mm eyelet dia.	2.5mm pilot hole.
<b>J0836g</b>	<b>Cancellous Screw.</b>	4.0mm.	16mm L.	2.0mm eyelet dia.	2.0mm pilot hole.
<b>J0836c</b>	<b>Cancellous Screw.</b>	4.0mm.	24mm L.	2.0mm eyelet dia.	2.0mm pilot hole.



**Suture Screw Anchor Set.** Used together with LigaFiba, suture screws offer a solution to joint stabilisation. Sizes range from 2.0 up to 4.0mm to cover the full range of patients. Suture screws are now available as a boxed set including 2 of each suture screw (16) together with the new universal introducer which fits all the screws. Also included in the kit is one of each LigaFiba sterile suture packs: 150lb, 150lb and 500lb.

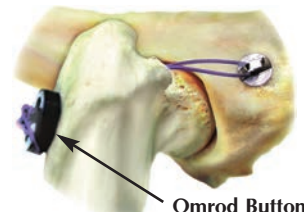

**J0836k** **Suture screw kit** (Includes stainless case, introducer, 16 suture screws and 3 sterile LigaFiba packs)

Also required:

- J0837u** **Universal Insertion Tool** for 2mm, 2.7mm, 3.5mm and 4mm suture anchor.
- J0863x** **Omrod Button.** (optional)
- J0444b** **250lb LigaFiba sterile pack** 24" for ligament replacement.

For tendon repair:

- J0444db** **150 lb LigaFiba tendon suture** with 2 straight needles.



**Suture Anchor Pin.** A threaded suture anchor is machined into the tip of a trochar pin. Immediately proximal to the suture anchor is a narrow break off point. The construct is stable during axial drilling of the pin into bone. Once in position with the hole of the anchor just above the surface of the bone, the shaft of the pin is rocked to and fro. The stainless steel undergoes work hardening and become very brittle, ultimately breaking off leaving the anchor in position ready for placement of sutures. The suture anchor pin is extremely easy to position and place without pre-drilling.

- J0836x** **Suture Anchor Pin** 2.5mm diameter x 0.7mm hole
- J0836y** **Suture Anchor Pin** 3.0mm diameter x 1.0mm hole
- J0836z** **Suture Anchor Pin** 4.0mm diameter x 2.0mm hole

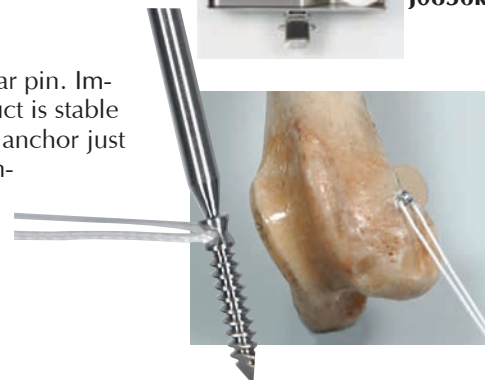



**J0049hd Ear Clamp.** Straight. 14cm. (5")

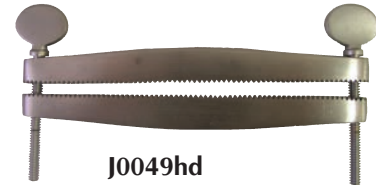

**J0049b Behney Ear Instrument.** Helps to avoid the problems associated with external bracing of cropped ears. Also very effective for getting problem ears to stand. Detailed literature and pictures available on request. Instrument consists of trocar, push rod, cannula, and wire implants. Two of each size. Stainless steel.

**J0049w Behney Wire Implant.** Sizes 2", 2 1/2", 3", 3 1/2", and 4". 6/pk.

- J-49wa 2"
- J-49wb 2 1/2"
- J-49wc 3"
- J-49wd 3 1/2"
- J-49we 4"

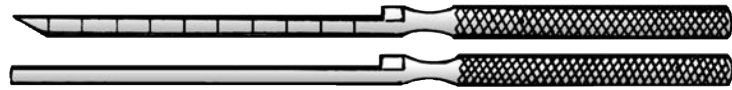

**J0045 Gowlland's Mayfield Veterinary Diagnostic Set.**

Includes:

- Medium battery handle. Uses 2 "C" batteries (not included).
- Otoscope head, 4x magnification
- 3 veterinary long specula: 80mm x 6mm, 80mm x 4mm, 58mm x 5mm.
- 1 spare bulb
- 1 ophthalmoscope head
- Case



J0045



J0045a

**J0045a Otoscope** with veterinary-length specula. Magnifies 4x. Uses 2 "C" batteries (not included).

**J0049f Buck Ear Curette.** Straight. Stainless steel. 6".  
**J0049fg Buck Ear Curette.** Straight. German-made. 6".  
**J0049g Buck Curette.** Curved head. 6".

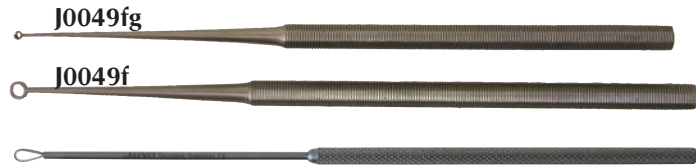

**J0049p Billeau Loop Ear Curette.** German-made. 6".



**J1059 Double Ended Disposable Ear Curettes.** These curettes are great for cleaning and help in examining ears. Three different configurations in a single pack. All three are 7.5" (19cm) long.

- Double-ended: efficiency and cost savings
- Position indicators – tells the location of the loop when out of view. This facilitates guidance and positioning.
- Flexible tips-allows for comfortable insertion
- Non-sterile

Shapes: Mini loop (for hardened wax), curve-loop, and small loop

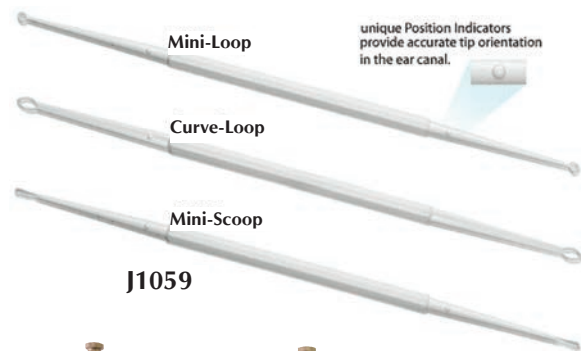

J1059

**J1059 Set of all three** (9 total)  
**J1059a Small scoop double ended** 3pk  
**J1059b Curve loop double ended** 3pk  
**J1059c Mini loop double ended** 3pk

**Ear Trim Clamp.** These clamps are specially designed for the individual shape of each breed. This allows for better cosmetic and more consistent ear trims. Directions included.

**J0049ma Schnauzer Pattern.** 12cm. 4.8"  
**J0049mb Boxer Pattern.** 13.5cm. 5.4"  
**J0049mc Doberman Pattern.** 15 cm. 6"  
**J0049md Great Dane Pattern.** 18.5cm. 7.4"  
**J0049me Boston Terrier Pattern.** 12cm. 4.8"  
**J0049ms Set of Five Clamps.**



J0049m series

**J0049s Earcrop Cartilage Scissors.** Heavy-duty scissors with one serrated edge. Stainless steel. 6 1/2".

**J0049x Martin Cartilage Scissors.** Heavier blades with one serrated edge. Useful for trimming ears. German-made. 8" (20cm).



**Vet Cam Video Scope.** The portability, high-resolution imaging and video recording make clinical diagnosis simple and practical. It educates the client in understanding the process resulting in increased compliance. This one of a kind video otoscope has multi-use capabilities. Designed with precision and cutting edge technology.

- Updated software makes it easier to capture and save pictures and video
- More specula options
- A specula with a SEPARATE working channel for unobstructed view
- More options for editing pictures and video — i.e. pen icon to draw lines on captured image, erase icon to erase lines that were drawn, pen color icon to provide a variety of color choices and aid in identification
- Full screen, half screen and quarter screen options for quick and easy side by side comparisons
- Separate image control icon for brightness, contrast, hue, saturation and sharpness provides overall enhanced picture quality
- Image management menu allows captures images to be saved in folder automatically

**Features:**

- **Portable.** This device is lightweight, allowing for single hand use.
- **Power.** No batteries or external power source is needed. It is powered through the USB port.
- **Light Source.** 6 LED bulbs allow 10,000 working hours.
- **High Resolution Imaging and Video Capture.** The VetCam with a quad VGA of 1280H x 960V, 15fps creates sharp and accurate imaging for easy diagnosis. The **Vet Cam** also records real-time video through live capture.
- **Multi Usage.** With its live capture, easy one-touch record and focus functions, the VetCam allows before and after imaging. It is capable of being used for multiple diagnosis as in skin lesions, dental tartar, ear infections and more.
- **Interchangeable Speculum.** Interchangeable disposable speculums offer medical professionals more flexibility for diagnosing.

*Product Specifications*

Parameter	Typical Value
Optical Format	1/4.5 inch VGA CMOS
Sensor Resolution	660H X 507V, 334,620 pixel
Effective Pixles	640H x 480V,307,200 pixel
Camera Function	Live & capture, record, focus
Sensor Pixel Size	3.6 m x 3.6 m

*One Year Limited Warranty on Parts & Labor.*

**J1100m VetCam**

- Includes software
- Interchangeable speculums (5)
- 1 speculum with working operating channel

**Vet Cam Pro** Includes:

- J1100d1s** **Set of 4 interchangeable speculum** (small, medium, large, and extra-large)
- J1100d1** **Speculum** - Small. (3mm x 32mm)
- J1100d2** **Speculum** - Medium. (4mm x 53mm)
- J1100d3** **Speculum** - Large. (5mm x 45mm)
- J1100d3xL** **Speculum** - Extra Large. (7mm x 52mm)
- J1100d8** **Separate Operating Channel Speculum** (7mm x 52mm)
- J1100d9** **Extension Cable.** 15'
- J1100d5** **Speculum** - 5mm x 70mm



- Otoloscope
- Dental
- Nasal
- Vaginal



**J1100m**



**J1100d1s**



**J1100d1**



**J1100d2**



**J1100d3**



**J1100d8**

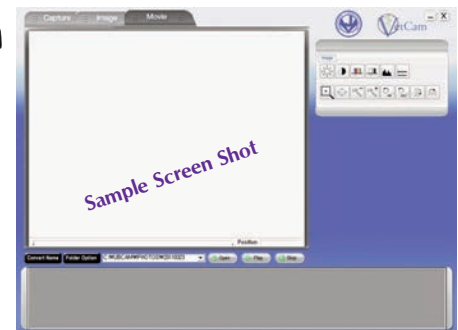

**More VetCam Accessories**

**Disposable speculums.** Useful in case where a single use product is preferred, i.e. pseudomonas infection. Speculums are green.

- J1100d12** 3mm x 36mm 50pk, green
- J1100d12a** 3mm x 36mm 100pk, green
- J1100d13** 4.6mm x 45mm 50pk, green
- J1100d13a** 4.6mm x 45mm 100pk, green
- J1100d14** 6mm x 50mm 50pk, green
- J1100d14a** 6mm x 50mm 100pk, green

**J1100d15** **Flexible stainless ear loop curette** (cats/small dogs)

**J1100d15a** **Flexible stainless ear loop curette** (med/large dogs)

This curettes can be passed down the slotted working channel to help remove debris/wax.



**J1100d16** **Malleable alligator grasping forceps** with 5" shaft. Works well for grabbing foreign bodies i.e. foxtail/grass awns deep in the ear canal.

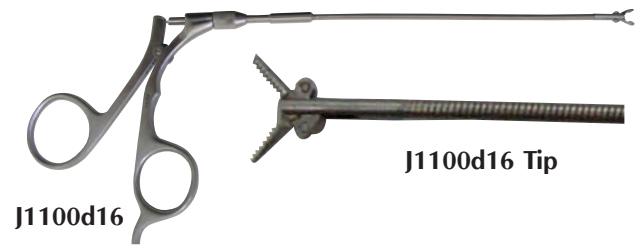

**J1100d17** **Malleable alligator biopsy forceps** 5" (14.5cm) shaft used as a grasper to take biopsies down deep in the ear canal. 2mm cup.

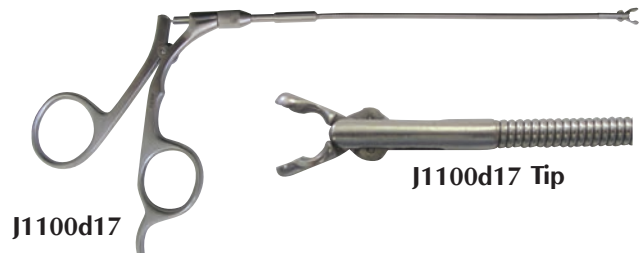

**Wax Eater. Ear Speculum Cleansing Device.** Any ear examined with an otoscope is going to result in a contaminated ear cone speculum. Wax or sebum tend to cling readily to the ear speculum. This can transfer bacteria, i.e. Psuedomonas, yeast, mites, and other microbes to the next patient. This speculum needs to be cleaned or disinfected between patients.

The **Wax Eater** uses specially designed cleaning brushes in a disinfectant solution to accomplish this job. A **Wax Eater** should be readily available in every exam room or anywhere an otoscope is used.

Weekly cleaning is recommended and suggest attaching a piece of tape with last cleaning date to base of Wax Eater. Brushes should be replaced after showing signs of heavy wear.

Warranty: Limited two year warranty against defects in manufacturing or materials from date of purchase, 3 months on brush components.

- J1184** **Wax Eater**
- J1184d1** **Wax Eater replacement brushes**  
(Brushes are compatible with other brands.)

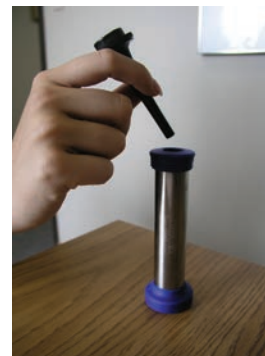



**Jor Vet AbsorbENT™ Ear Wick.** Ear Wicks have been utilized for a long time in human medicine. Recent improvements have made them a valuable adjunct to treating otitis externa for veterinarians. AbsorbENT™ sponges consist of a polyvinyl alcohol (PVA) with interconnecting open cells that are extremely soft and pliable. The interconnected cell structure produces a packing that is exceptionally strong, highly absorbent and virtually lint and fiber free. AbsorbENT™ is designed as an aid in treatment of otitis externa. When liquid medication is applied to the sterile, compressed sponge, it gently and evenly expands to fill the ear canal dispersing the medication and applying gentle pressure to the tissue.

- Expands rapidly for effective distribution of liquid medication
- Soft, pliable sponges enhance patient comfort while applying gentle pressure
- Compressed and sterile for rapid patient insertion and treatment
- Suture can be laced around the end for easy retrieval

Ear Wicks are perfect for:

- Clients who cannot readily treat their animal at home
- Refractory or challenging cases that are not responding to other treatment

Suggested use: Insert Ear Wick and infuse appropriate antibiotic or corticosteroid into sponge. Leave in place for a few days (probably no more than 4 days). The resulting reduction in edema or swelling will cause Ear Wick to be easily removed.

Note: Ear Wicks are designed for Glycol or aqueous otic solutions. They will not work with oil based emulsions such as Panalog® (Ft. Dodge Animal Health). Also, for large breed dogs (over 80 lbs) 2 or more Ear Wicks may be required.



**J1084 Ear Wick** 9mm diameter x 15mm length (50/pk)

**J1084a Ear Wick** 9mm diameter x 24mm length (50/pk)

**J1084sk Starter kit**, 5 of both sizes (10 total)

Ear Wicks come in individual packages of 50. Sterile.

**J1084k Absorbent Ear Wick** 9mm diameter x 15mm length (5/pk)

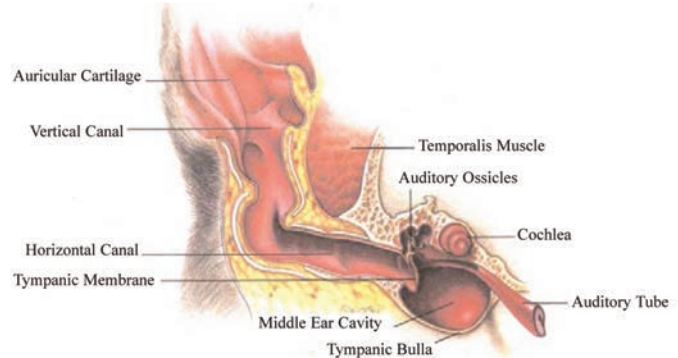

**J1339 Flushing Kit.** This kit allows controlled flushing.



- Spike hooks to IV bag with flushing medication
- Bivalve has female luerlock and male luerlock
- Connect syringe to female luerlock to either flush or aspirate
- Male luerlock: attach needle or catheter for flushing of ear, wound, joint, or other desired flush

Vented IV spike with 36" (90cm) tubing connects to bivalve connector for flushing/aspiration. Sterile.

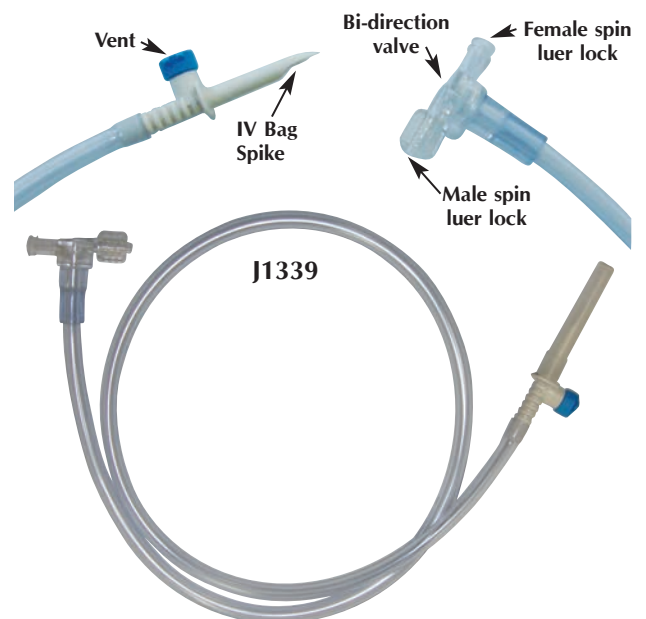

**Brown "Cling" Gauze.** Our brown "cling" gauze is 100 percent pure cotton and comes in fine 24 x 17 mesh.

- J0192a** **Brown "Cling" Gauze.** 3" x 5 yds. 12/pk. 50 pk/case.
- J0192b** **Brown "Cling" Gauze.** 6" x 5 yds. 12/pk. 25 pk/case.



J0192a & J0192b

**Sponge Gauze.** Our sponge gauze is 100 percent pure cotton and comes in a 20 x 12 mesh. It is fully bleached and meets the USP standard.

- J0193a** **Sponge Gauze.** 2" x 2". 8-ply. 200/bag. 80 bags/box.
- J0193b** **Sponge Gauze.** 3" x 3". 12-ply. 200/bag. 20 bags/box.
- J0193c** **Sponge Gauze.** 4" x 4". 8-ply. 200/bag. 20 bags/box.
- J0193d** **Sponge Gauze.** 4" x 4". 12-ply. 200/bag. 10 bags/box.



J0193a, J0193b, J0193c and J0193d

**J0195** **JorVet Cotton Tip Applicator.** Our JorVet cotton tip applicators are 6"L and come with a wooden stem and single cotton tip. 100/bag, 24 bags/box.

**J0195a** **Wood Applicator Stick.** 6" hardwood applicator stick useful for mixing and stirring compounds and lab samples. Handy zip lock bag. 100/bag, 24 bags/carton.

**Laparotomy Sponge.** Prewashed 8-ply lap sponges, radio-opaque with loops. Useful in retaining body structures during deep abdominal surgery. (Not pictured)

- J0490a** **Sponge.** 18" x 18". Non-sterile. 5/pkg.
- J0490as** **Sponge.** 18" x 18". Sterile. 2/pkg.
- J0490b** **Sponge.** 4" x 18". Non-sterile. 5/pkg.
- J0490bs** **Sponge.** 4" x 18". Sterile. 2/pkg.



J0490 series



J0195



J0195a



JorVet offers an expanded range of **White Goods** that offer the highest quality yet at affordable pricing.



J0570, 0571, 0572 & 0573

**New Weave Gauze Sponge.** Synthetic rayon and polyester non-woven fabric. These sponges are lint free, superior in strength and 50 percent more absorbable than cotton sponges.

- J0570a Gauze Sponge** 2" x 2". 4-ply. 200/pk, 40 pk/case.
- J0570b Gauze Sponge** 3" x 3". 4-ply. 200/pk, 20 pk/case.
- J0570c Gauze Sponge** 4" x 4". 4-ply. 200/pk, 20 pk/case.

**Poly Stretch Conforming Bandage.** The unique bandage pattern allows controlled stretch compared to cling gauze. It molds to any body shape to allow freedom of movement. It is also soft and light weight.

- J0571a Bandage.** 1" x 4.1 yds. 12/pk, 8 pk/case.
- J0571b Bandage.** 2" x 4.1 yds. 12/pk, 8 pk/case.
- J0571c Bandage.** 3" x 4.1 yds. 12/pk, 8 pk/case.
- J0571d Bandage.** 4" x 4.1 yds. 12/pk, 8 pk/case.

**Sensi Wrap Cling Gauze Bandage.** 2-ply high quality cotton gauze that is excellent for general bandaging.

- J0572a Bandage.** 2" x 4.5 yds. 12/pk, 8 pk/case.
- J0572b Bandage.** 3" x 4.5 yds. 12/pk, 8 pk/case.
- J0572c Bandage.** 4" x 4.5 yds. 12/pk, 8 pk/case.
- J0572d Bandage.** 6" x 4.5 yds. 6/pk, 8 pk/case.

**Superfluff Gauze Bandage.** A 6-ply 100 percent cotton gauze that is very soft with fluff dried heavy-ply for cushioning and protection

- J0573 Bandage.** 4 1/2" x 4.1 yds. 12/bag, 4 bags/case.

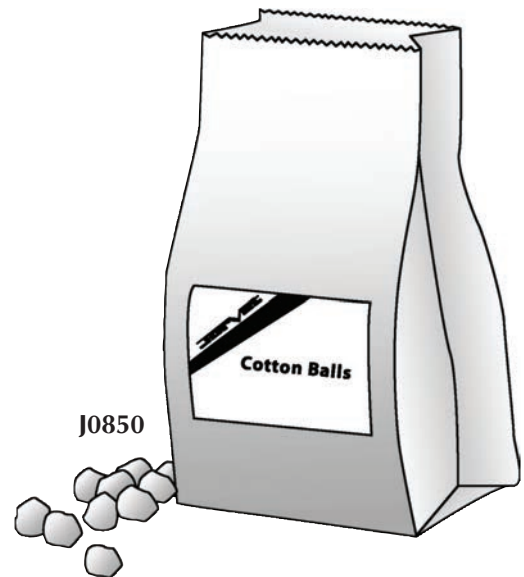

J0850

- J0850 Cotton Ball.** Medium fluffy quality cotton. 2000/paper bag.



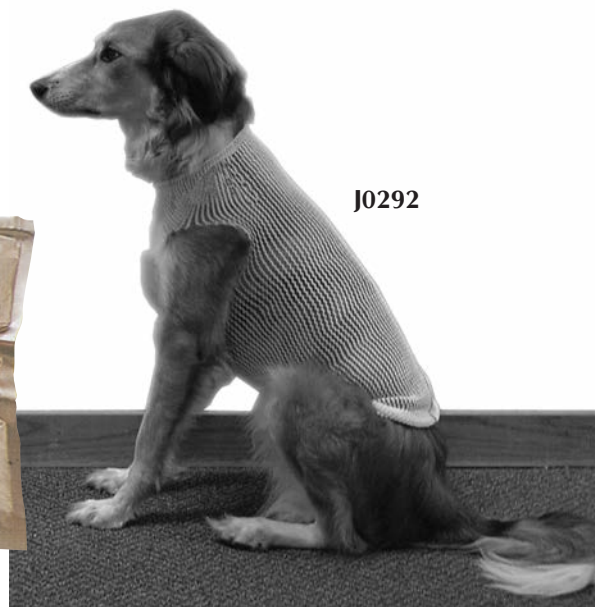

J0292

**JorVet Fiberglass Casting Tape.** A woven fiberglass mesh that is impregnated with polyurethane. It is activated by submersion in water. *Many competing tapes are only 3 yards long!*

- Lightweight yet durable
- Waterproof
- Easily shaped
- Packaged in foil pouch

<b>J0574a</b>	<b>Tape.</b> 2" x 4 yds.*	5/case.
<b>J0574b</b>	<b>Tape.</b> 3" x 4 yds.*	5/case.
<b>J0574c</b>	<b>Tape.</b> 4" x 4 yds.	10/case.

**X-Span Tubular Dressing.** This tube-shaped gauze material is designed to hold a primary dressing in place. It is excellent for use on body parts that are difficult to secure with tape (i.e., the head). The material has a remarkable amount of stretch for optimum fit. Mid-line colored stripe for orientation.

<b>J0292</b>	<b>Dressing.</b> 16mm W. Yellow.
<b>J0292a</b>	<b>Dressing.</b> 25mm W. Dark Green.
<b>J0292b</b>	<b>Dressing.</b> 32mm W. Light Green.
<b>J0292c</b>	<b>Dressing.</b> 60mm W. Turquoise.
<b>J0292e</b>	<b>Dressing.</b> 75mm W. Purple.

*NOTE: Approximate width unstretched.  
8 yd/roll=30 stretched yds.*

**Orthopaedic Stockinette.** Choice of polyester or cotton.

<b>J0291b</b>	<b>Polyester Stockinette.</b> 2" x 25 yds.
<b>J0291c</b>	<b>Polyester Stockinette.</b> 3" x 25 yds.
<b>J0291d</b>	<b>Polyester Stockinette.</b> 4" x 25 yds.
<b>J0291e</b>	<b>Polyester Stockinette.</b> 6" x 25 yds.
<b>J0291bc</b>	<b>Cotton Stockinette.</b> 2" x 25 yds.
<b>J0291cc</b>	<b>Cotton Stockinette.</b> 3" x 25 yds.
<b>J0291dc</b>	<b>Cotton Stockinette.</b> 4" x 25 yds.
<b>J0291ec</b>	<b>Cotton Stockinette.</b> 6" x 25 yds.

**J0197** **One-Pound Roll Cotton.** Great for wound care and padding. Bright white, seed-free long stem cotton. Layers in roll separated by blue paper. Outer white poly bag. 30 rolls/case.



J0292 Series



J0291 Series

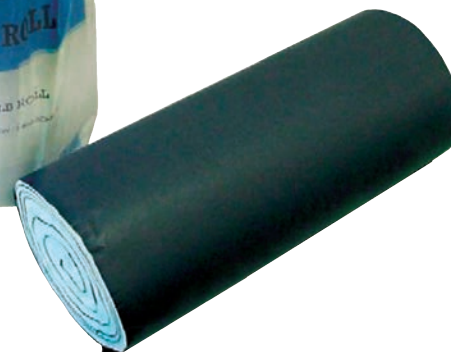

**Ace-Knitted Elastic Compression Bandages.** These are the familiar beige stretch bandages. They are very useful for long standing injuries that require a large number of bandage changes. Choice of two closure styles. Individually wrapped.

**Standard Bandage with Metal Retention Clip.**

- J0858** Bandage with Clip. 2"W. 186" L stretched.
- J0858a** Bandage with Clip. 3"W. 186" L stretched.
- J0858b** Bandage with Clip. 4"W. 186" L stretched.
- J0858c** Bandage with Clip. 6"W. 168" L stretched.

**Elastic Compression Wrap with Self-Closure Velcro.**  
Both ends have velcro for easy starting and closure.

- J0859** Bandage with Velcro. 2"W. 186" L stretched.
- J0859a** Bandage with Velcro. 3"W. 210" L stretched.
- J0859b** Bandage with Velcro. 4"W. 210" L stretched.
- J0859c** Bandage with Velcro. 6"W. 210" L stretched.

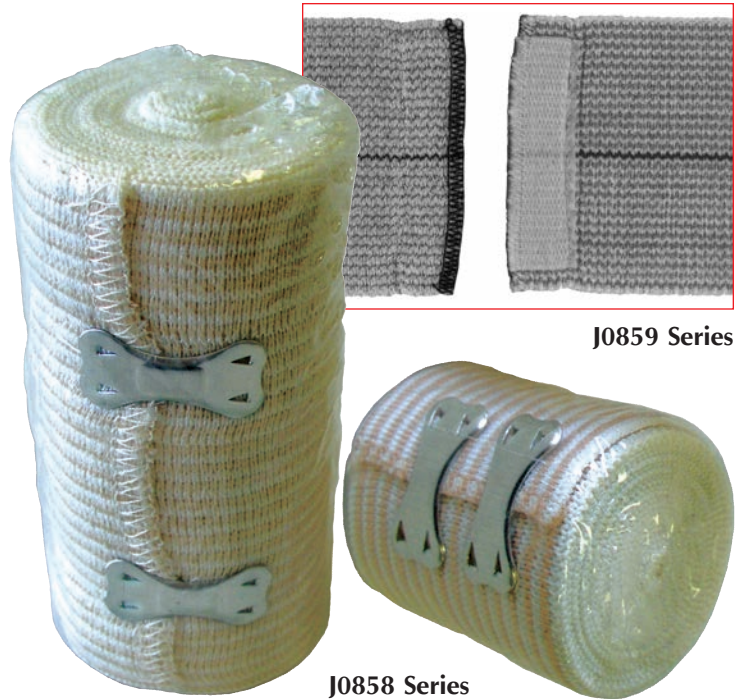

**JorVet Gauze Roll Bandage.** This single-ply cotton gauze bandage conforms to a wide range of uses around the clinic besides the normal wound bandaging. Thick 28 x 24 mesh covered in paper. 10 yd L. 12 rolls/pk.

**Applications:**

- Wrapping over primary dressings
- Simple muzzles
- Tying endotracheal tubes during intubation
- Surgical tie downs

- J0888** JorVet Gauze Roll Bandage. 1"W.
- J0888a** JorVet Gauze Roll Bandage. 2"W.
- J0888b** JorVet Gauze Roll Bandage. 3"W.
- J0888c** JorVet Gauze Roll Bandage. 4"W.



**J1079 Absorbent Wound Pads.** These pads lift and remove wound exudate in the same way that a disposable diaper works. The outer layers are a thin layer that allows moisture to pass into the thick middle absorbent layer. This keeps the wound surface dry. 5" x 9" green midline strip. It can be trimmed for sizing. Sterile package in chevron pouch. 25 pieces/ box. Less expensive and more absorbent than telfa pads.

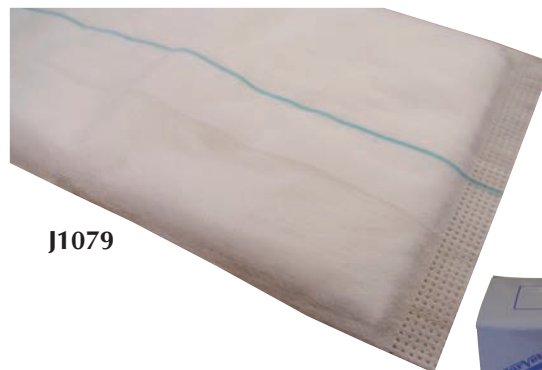

**J0196 Wooden Tongue Depressors.** Quality birch-wood tongue depressors enjoy a wide variety of uses around the veterinary clinic. 500/box 10 boxes/case, standard size 6" x 3/4".





**White Surgical Adhesive Tape.** These rolls are on a unique red plastic spool with a protective cover. Priced at considerable savings.

**J0820e Tape.** 3" W. 10 yds L. 6 rolls/box.



**J0820 Series**

**Vet Lite Casting Material.** This product was a popular product that was discontinued a few years ago in the veterinary field. It is now available once again

Constructed of thermoplastic white mesh. When heated in hot water it turns into a soft malleable material that can be shaped into any configuration. Hardens as it cools.

- Can be reheated and reshaped
- Partially used material may be retained for future use
- Waterproof
- Gloves not required
- Long shelf life

**Vet Lite Roll.**

**J0758a Roll.** 2"W x 70"L. 10 rolls/box.

**J0758b Roll.** 3"W x 70"L. 10 rolls/box.

**J0758c Roll.** 4"W x 70"L. 10 rolls/box.

**J0758d Roll.** 6"W x 70"L. 10 rolls/box.



**J0758 Series**

**Vet Lite Sheet.**

**J0758sa Sheet.** 3"W x 15"L. 15 sheets/pk.

**J0758sb Sheet.** 4"W x 15"L. 15 sheets/pk.

**J0758sc Sheet.** 6"W x 15"L. 15 sheets/pk.

**X-Lite Foam Cast Padding.** Off white, lightweight open-cell foam padding. Great for cast padding or protecting bony protuberances. (not pictured)

**J0759 Padding.** 7.5cm (3") x 2.75m (107"). 10 rolls/pk.

**J0759a Padding.** 13cm (5.2") x 2.75m (107"). 10 rolls/pk.

**J0759 & J0759a**



**Standard White Porous Tape.** High quality "athletic" white porous cloth tape that can be torn easily. Priced at considerable savings

**J0820ab Tape** 1/2" W. 10 yds L. 12 rolls/box

**J0820an Tape** 1" W. 10 yds L. 12 rolls/box

**J0820bn Tape** 2" W. 10 yds L. 6 rolls/box

**J0820dn Tape** 3" W. 10 yds L. 6 rolls/box

**J0820en Tape** 4" W. 10 yds L. 6 rolls/box



**J0820 series**

**J1030 Elastic Adhesive Bandage tape.** Similar design to Elastikon® from J & J but at considerable savings. This stretchable tan woven fabric is a very familiar looking tape with red centering line. 5yds in length

**J1030a** 2"x 6 rolls/box

**J1030b** 3"x 4 rolls/box

**J1030c** 4"x 6 rolls/ box



**J1030 series**

**Cast Padding.** Soft 100% cotton cast padding. Comfort padding for use under cast or as a protective bandage. Priced to be competitive!!

**J0293a** 2" width x 4 yds long

**J0293b** 3" width x 4 yds long

**J0293c** 4" width x 4 yds long

**J0293d** 6" width x 4 yds long





**Equine Leg Wrap.** Made of soft quality bulk cotton which is covered on both sides with a permeable thin layer of non-woven material. The wrap acts much like a diaper in that the wound exudate is lifted and absorbed into the thick middle cotton layer. A dark mark mid-line runs full length to give proper orientation during application. A wide variety of materials and sizes are now available:

- J0849 Bulk Equine Leg Wrap.** 12" x 10 yd.
- J0849a Bulk Equine Leg Wrap.** 14" x 10 yd.
- J0849b Bulk Equine Leg Wrap.** 16" x 10 yd.

- J0849an Equine Leg Wrap.** 12" x 36". Non-sterile.
- J0849bn Equine Leg Wrap.** 12" x 42". Non-sterile.
- J0849cn Equine Leg Wrap.** 14" x 42". Non-sterile.
- J0849dn Equine Leg Wrap.** 16" x 54". Non-sterile.

- J0849as Equine Leg Wrap.** 12" x 36". Sterile.
- J0849bs Equine Leg Wrap.** 12" x 42". Sterile.
- J0849cs Equine Leg Wrap.** 14" x 42". Sterile.
- J0849ds Equine Leg Wrap.** 16" x 54". Sterile.
- J0849q Equine "Army Surplus" Brown Leg Wrap.** This popular wrap was originally an army surplus product. The thick pad is brown on one side, white on the other. It is combined with two rolls of 6" brown cling gauze for a complete wrap. 18" x 22" brown gauze pad.



**Gel Cast or "Unna Boot".** This pink soft cast or bandage is useful for the management of soft tissue sprains or lower leg edema. The cast is actually a bandage material that is 100 percent cotton gauze evenly impregnated with a non-hardening zinc oxide paste. Considered a primary dressing that should be covered with a secondary bandage. Rolled and packaged in individual vacuum sealed pouches.

*Features and benefits:*

- Contain zinc oxide paste to allow bandages to stay moist and comfortable, encouraging ambulation
- Thread locking edges that prevent unraveling
- Non-gelatin. Does not cake or harden, stays soft over an extended period of time
- No preservatives that may cause allergy or hypersensitivity
- Vacuum sealed pouch prolongs shelf life.

- J0880 Gel Cast.** 3" x 10 yd.
- J0880a Gel Cast.** 4" x 10 yd.



**Equine Bandage Sheeting.** Popular "sheet" material constructed of thin sheet spun fibers. Highly absorbent material that offers excellent protection at an affordable price. Packaged in two forms. (not pictured)

- J0871 Equine Bandage Sheet.** 30" x 36" Rolled and packaged in poly bag. 12 sheets per bag, 20 bags.
- J0871b Equine Bandage Sheet.** 30" x 28" bulk in large flat bale. 240/bale.

**Tube Gauze.** Commonly used in bandaging cat declaws. Also can be used as a stockinette on cats and smaller animals. A very fine weave of 100% cotton that is knitted in a continuous seamless tube. Roll in dispensing box

- J0290a Roll** 5/8"(w)x 50 yds.
- J0290b Roll** 1"(w)x 50 yds.
- J0290ap Metal applicator cage** for 5/8" tube gauze



**Sterile Impervious Orthopedic Stockinette.** The vast majority of veterinary surgeons use the "hanging leg" technique for surgeries involving the extremities. The distal leg is wrapped with a sterilized cohesive bandage; the balance of the leg is draped. An article in "Veterinary Surgery" discusses the possibility of strike through contamination and recommends the use of impervious stockinettes. "Evaluation of wraps covering distal aspect of pelvic limbs for prevention of bacterial strike through in an ex vivo canine model." The recommended product is impervious stockinette. This product has a blue rubber Kraton® cover standard polyester stockinette with one end sealed closed. It is rolled up and provided sterile in a chevron pouch.

- J0339** 1" x 12"
- J0339a** 2" x 15"
- J0339b** 3" x 20"

**J0339 series**





**Kruise Manuka Honey Dressings.** JorVet sweetens its dressing range. “For over 2,000 years honey has been used as a topical anti-microbial agent and dressing; specifically honey derived from the nectar of the Manuka tree (*Leptospermum scoparium*) has its own unique chemical properties. Manuka honey contains glucose oxidase imparted by the bees during its collection and storage. The enzyme facilitates low level release of hydrogen peroxide when in the presence of wound exudates and thus supports cellular proliferation and metabolism through an antioxidant effect. The high sugar and low pH content creates a high osmotic potential which gives honey excellent debridement and anti-inflammatory properties.

One of the biggest difficulties with the use of honey in wound dressings is ensuring that once applied it stays over the wound area. Many attempts to coat dressings have been unsuccessful; often the active honey ingredient is left within the packaging severely reducing the effectiveness of the dressing. Kruise Manuka dressings come from a process that has successfully impregnated the active honey within the dressing. This process ensures precise and easy application even if wearing surgical gloves.

The antimicrobial potency in Manuka honey is rated by a standardized rating known as Unique Manuka Factor (UMF); the higher the UMF the better the antimicrobial effect. A minimum UMF of 10 is required to ensure sufficient effect in the wound environment; Kruise Manuka Honey Wound Dressings have a Unique Manuka Factor of 15.

There is a restricted annual supply of Manuka honey as this unique product supply is controlled by a small number of producers in New Zealand. Many current honey products available use blends of Manuka honey with other poorer quality honey, these are often less effective. JorVet Manuka uses 100% Manuka honey in all its dressings with a portion of the profits of the sale being returned directly to the Maori tribe that oversees the production of Manuka honey.

**Manuka ND.** Honey impregnated **non-adherent dressing.** Primary wound dressing. 100% *Leptospermum scoparium* honey from New Zealand impregnated into acetate gauze. The dressing promotes a moist wound environment conducive to healing. Indications:

- Traumatic and contaminated wounds
- Sloughy wounds requiring autolytic debridement
- Superficial and partial thickness burns

- J1251** **Manuka ND 5x5cm non-adherent dressing.** 10/pk, sterile.
- J1251a** **Manuka ND 10x12.5cm non-adherent dressing.** 10/pk, sterile.
- J1251b** **Manuka ND 10x100cm non-adherent dressing.** 1 roll, sterile.

**Manuka AD.** Honey impregnated **absorbent dressing** for moderate to heavy exuding wounds. 100% *Leptospermum scoparium* honey from New Zealand impregnated into a pad of super absorbent polymers. The dressing maintains a moist wound environment conducive to healing. Indications:

- J1252** **Manuka AD 5x5cm absorbent dressing.** 10/pk, sterile.
- J1252a** **Manuka AD 10x12.5cm absorbent dressing.** 10/pk, sterile.
- J1252b** **Manuka AD 10x100cm absorbent dressing.** 1 roll, sterile.

**Manuka G.** Sterile honey wound dressing **in a tube.** 100% *Leptospermum scoparium* honey from New Zealand. May be used to add honey directly to the wound and provide a moist wound environment conducive to healing. Indications:

- Traumatic and contaminated wounds including minor abrasions and lacerations
- Sloughy wounds requiring autolytic debridement
- Superficial and partial thickness burns
- Cavity wounds including abscesses
- Pressure sores
- Surgical wounds

- J1253** **Manuka G 15g tube of gel.** 10/pk, sterile.

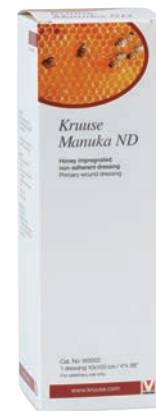

## JorVet Wound Management

Veterinarians encounter a wide range of serious open wounds from a variety of sources. The wound healing process is a predictable sequence of cellular and biochemical events. The father of advanced wound care, Dr. George Winter, demonstrated clearly in the 1960's that a moist wound healing environment was the key component in wound healing success.

JorVet has a family of wound care products that follow the well known phases of wound healing:

- Hemostasis
- Inflammation
- Proliferation
- Maturation and remodeling

JorVet wound healing products strive to maintain a moist wound environment by

- Absorbing excess exudates 'wet to dry'
- Donate moisture in cases where wounds are dry or not hydrated properly
- Antimicrobial but not cyto-toxic

### Some JorVet DON'TS on advanced wound care:

- **Dry Dressings** such as non-adherent or Telfa pads are designed for post surgical wound care and are not the best choice in moisture management of open wounds
- **Ointments and Sprays** – many commonly used ointments and sprays such as chlorhexadine and nitrofurazone are antimicrobial, but also cytotoxic to important healing cells such as fibroblasts, they can also chemically alter the wound environment rendering non-cellular wound healing factors such as cytokines ineffective. In addition, they add to the overall cost. Most wounds can be best served by simply enhancing the body's own regenerative abilities.

### Dressing for Absorption. Kruse Polyurethane Foam Dressing Pads:

- very light weight, open small pore hydrophilic foam pads
- Great absorptive capacity and can conform to wound shape
- Semipermeable outer film allows vapor to permeate through, but keeps bacteria from entering

#### Key Functions

- Absorption of fluid i.e. exudates
- Protective barrier
- Maintenance of moist wound environment
- Can be trimmed for proper sizing
- Sterile

- J1258** 5cm x 5cm 10/pack
- J1258a** 10cm x 10cm 10/pack
- J1258b** 15cm x 15cm 5/pack

**Dressings for Hydration.** Many times in the later stages of wound healing it will become dry and healing will slow. A wound will heal much faster without a heavy dried scab. Hydrogel or moisture donating gels contain high levels of water or moisture that rehydrate to maintain the moist wound environment. They consist of methylcellulose plus polyhexanide 0.04%. The hydrogel will perform best with Kruse polyurethane foam as a second dressing.

- J1259** Kruse Hydrogel 15 ml dispensing tube. 10/pack

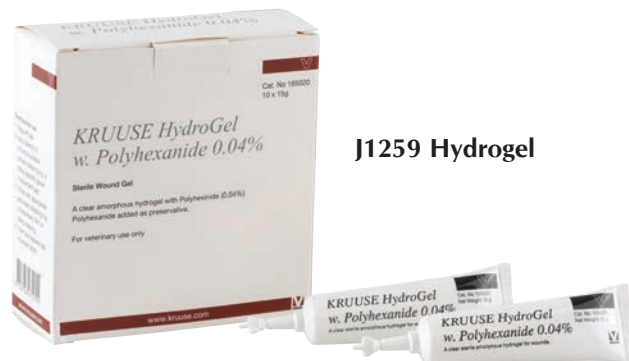
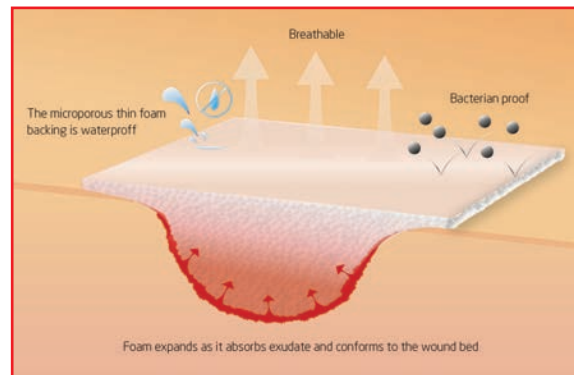
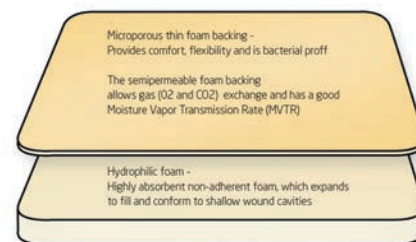

**J1259 Hydrogel**



**Buster Anti-Lick Strips.** Wound designed to stop licking, biting, and chewing for dogs and cats. A special process imbeds disagreeable flavors that immediately discourages licking when smelled or tasted. One side of the strip is standard adhesive and the other is impregnated with:

- Cayenne paper
- Oregano
- Lemon powder
- Peppermint

**Nontoxic.** Two types: one for placing directly on to skin and the other for placement on to bandage materials.

**Odor and taste deterrent for use around:**

- Surgical wounds
- Lick granulomas
- Insect bites
- IV cannula
- Anxiety licking
- Obsessive or anti-social lick behavior



**J1260 Buster Anti-LickStrip Pro**

- 245cm dispenser roll that can be trimmed to desired length
- Place above, below or around a wound site

Application will last up to 5 days

**Easy to apply** in 3 simple steps:

1. Shave or trim;
2. Degrease – alcohol wipe; and
3. Dry and apply

**J1260a Buster Anti-LickStrip Pro C**

- 245cm dispensing roll
- A stronger medical grade adhesive for use over dressings or casts

Application will last up to 5 days.



J1260a

**Absorbable Hemostatic Products**

**Equison Bio-Absorbable gelatin foam sponge.** A local hemostatic sponge for use in surgical procedures that involve venous bleeding and oozing where standard hemostats are difficult or impractical

- Achieves hemostatis rapidly in a few minutes.
- Can be trimmed to size or sutured in place
- Absorbs 50 times its own weight
- Uniform porosity
- Can use with medications and not affect its hemostatic properties
- Sterile double packaged

**J1275 125mm x 80mm x 10mm sheets**

(5" x 3.2" x 0.4")

**J1275a 80mm x 50mm x 1mm strip**

(3.25" x 2" x 0.04")



**Equicel Hemostatic absorbable dental gauze.** For use in surgical procedures to assist in control of capillary venous, or small arterial hemorrhage when ligation or other conventional methods are not practical or effective.

Equicel is a highly oxidized form of cellulose. Upon contact with the blood, it will absorb it and eventually dissolve into a gelatinous type material. By briefly applying pressure at this point, the material will adhere to the bleeding site resulting in a hemostatic effect.

Equicel is a highly oxidized form of cellulose. Upon contact with the blood, it will absorb it and eventually dissolve into a gelatinous type material. By briefly applying pressure at this point, the material will adhere to the bleeding site resulting in a hemostatic effect.

- Completely absorbed in body after one week
- Neutral pH so will not inactivate prothrombin
- Bactericidal against wide range of bacteria
- No Kaolin so can be safely buried and left
- Can be trimmed and sutured
- Sterile

*Some indications:*

- Biopsies such as liver and kidney
- Dental tooth extraction into empty socket

**J1276a 15mm x 15mm 60/pack**



J1276a

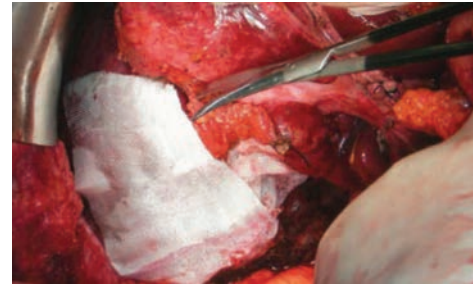
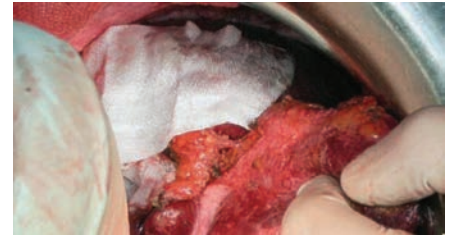

**Equicel Hemostatic powder.** 2gm in small dispensing vial. Useful where a powder hemostatic agent is preferred versus a gauze of sponge.

- Sprayed directly on the wound site
- Fully absorbed in one week
- Neutral non-reactive pH
- Bactericidal against wide range of bacteria
- Highly oxidized form of cellulose from cotton
- Sterile

*Indications*

- Dental tooth extractions
- Oozing skin wound bed
- Small areas of bleeding

**J1277 2gm Equicel powder**



J1277  
Equicel powder

**Equicel®-Silk Absorbable hemostatic gauze**

- Oxidised regenerated cellulose with hemostatic effect.
- Made from cotton / silk
- Suitable for all types of surgery
- Shelf life 3 years
- Store under 30°C
- CE Class III registered

Equicel is prepared by oxidising a suitable form of cellulose from natural cotton. This is followed by additional processes in order to obtain a pure and high-quality form of oxidised and regenerated cellulose. It is strong and although a slight discoloration may occur with age, this does not affect performance.

Equicel is immediately available for use in the operating theatre and does not require any sterilisation by dry heat or autoclaving. Equicel can be sutured or cut without fraying. The products are double packed, double sterile.

Due to its neutral pH, Equicel does not inactivate thrombin. With Equicel, hemostasis is achieved within a few minutes. Once implanted into tissue, Equicel is fully resorbed, independent of the circumstances. In addition to its local hemostatic properties, Equicel is a proven bactericide in vitro against a wide range of gram positive and gram negative organisms including aerobes and anaerobes.

**J1276 10cm x 20cm gauze, 4" x 8"**



J1276

- J0185** **Balling Gun with Spring Clip.** 2<sup>3</sup>/<sub>8</sub>"L, 1" dia. head.
- J0185p** **Plastic Head with Spring Clip.** 2<sup>1</sup>/<sub>2</sub>"L, 7/<sub>8</sub>" dia. head.
- J0185s** **Calf Balling Gun Clip.** 1<sup>1</sup>/<sub>2</sub>"L, 5/<sub>8</sub>" dia. head.

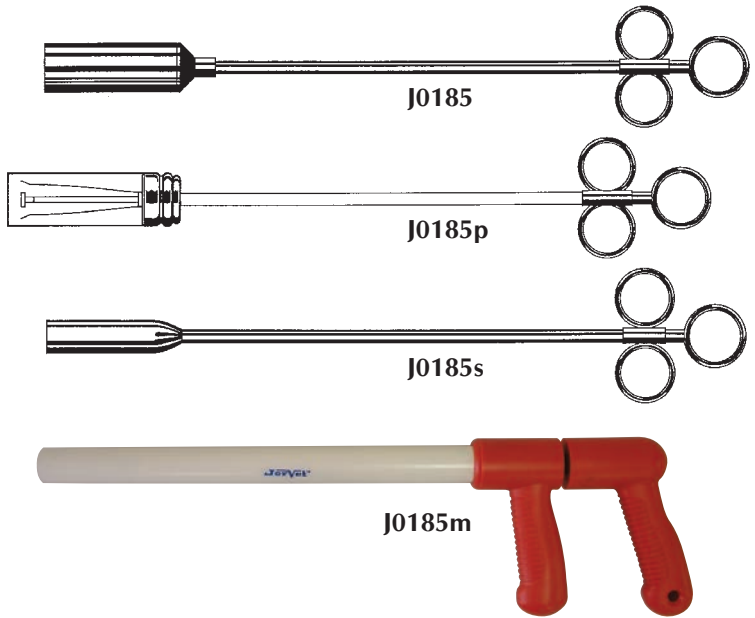

**JorVet Multi-dose Balling Gun.**

- Simplest design for ease of administration
- High impact PVC tube
- Holds enough boluses of any size for any procedure
- Lightweight, only 1.5 lbs.
- Field-tested for over 5 years at some of the country's largest feed yards

- J0185m** **Adult Balling Gun.** Holds up to six full-size boluses. 7/<sub>8</sub>" dia.
- J0185ms** **Calf Balling Gun.** Holds up to five calf-size boluses. 5/<sub>8</sub>" dia. Blue handle.

**Plastic Balling Gun.** Offers an economical alternative to standard metal balling guns.

- J0793** **Balling Gun.** Calf. 5/<sub>8</sub>" dia. head. Blue. 13<sup>1</sup>/<sub>2</sub>"L.
- J0793a** **Balling Gun.** Calf, with ribbed 5/<sub>8</sub>" dia. head. White.
- J0794** **Balling Gun.** Cow. 7/<sub>8</sub>" dia. head. Red. 17<sup>1</sup>/<sub>2</sub>"L.



- J0179** **Kant Suk Calf Weaner.**

**Lamb Nipple.** Natural feeling rubber with "X" pierced tip fits most soda type bottles. Raised ridge inside helps hold nipple onto bottle. Side tab helps pull off and on.

- J0920r** **Lamb Nipple.** Red. 4/pk.





**J0138c Oral Calf Drencher.** This familiar style of semi-rigid container has a screw-on cap with a plastic esophageal probe with a rounded end cap. Measurements are marked on the container. Holds 3 pints.

**J0138cp Oral Calf Drencher.** Same as J0138c, except stainless steel esophageal probe with a rounded end cap.

**J0138g Oral Calf Drencher.** Large 1 gallon container. Plastic esophageal probe style same as J0138c. Added air vent.

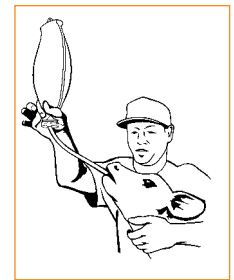

**J0138c**  
One Hand  
Operation

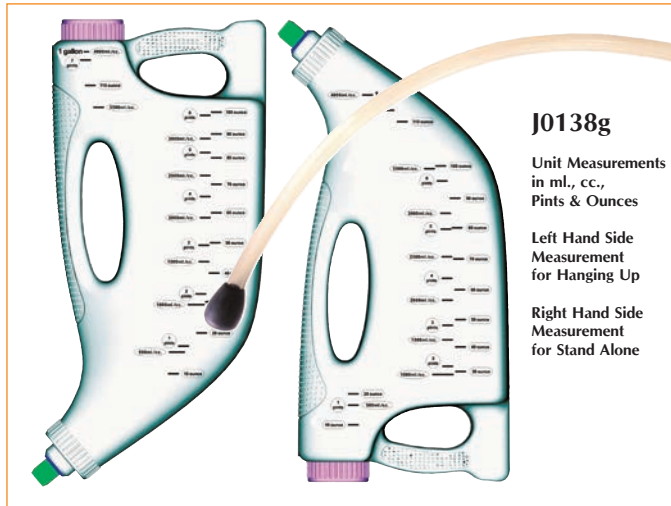

**J0138g**

Unit Measurements  
in mL, cc.,  
Pints & Ounces

Left Hand Side  
Measurement  
for Hanging Up

Right Hand Side  
Measurement  
for Stand Alone

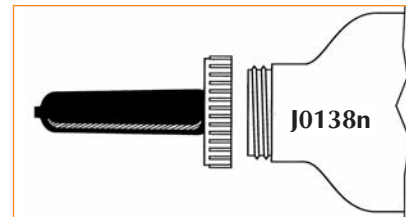

**J0138n Nipple with Cap.** This red rubber nipple attaches to the J0138c oral calf feeder bottle.

**J0138 JorVet Calf Drencher.** Collapsible 2 1/2-liter bag with special rigid probe.

- 3-track watertight closure aids easy filling
- Rigid top portion with holes for easy handling or hanging
- On/off flow clamp
- Special cold temperature-resistant plastic will not crack
- Round ball-shaped end aids proper placement
- Graduated marking both liters and quarts

**J0137m Bovi-Vet® Calf Drencher,** modified. A safe and quick method for oral liquid therapy in calves. 2-liter container.

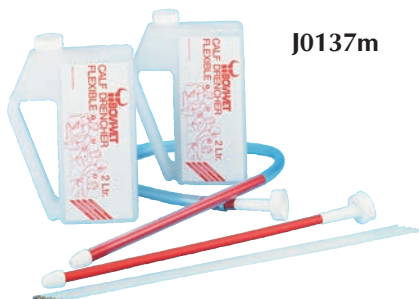

**J0137m**



**J0138**

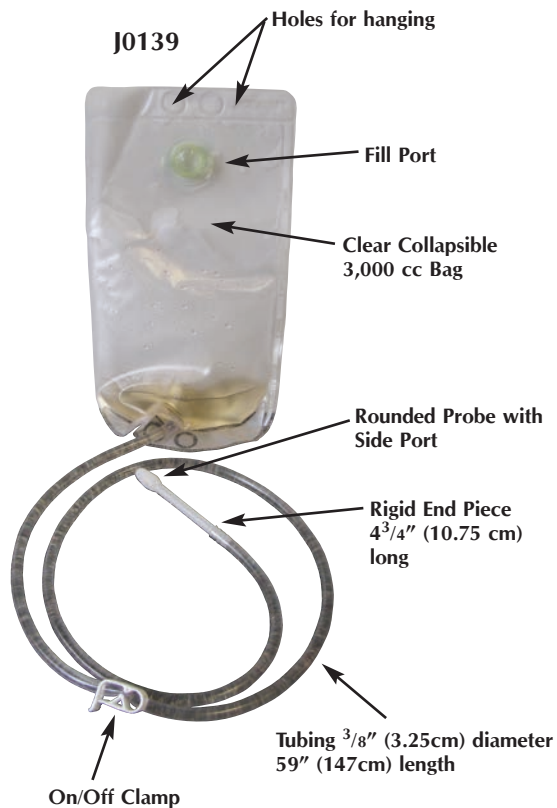

**J0139 Enema or oral calf feeder bag.** This bag was originally developed for enemas on larger patients. It has also found use as an oral calf feeder. Plus, it is less expensive. Short rigid end probe: helps ease passage. Round probe end with side port: helps prevent occlusion. 3000 cc capacity

**Speedy Calf Drencher.** The premium oral calf feeder.

- Allows a one-handed delivery
- Multi-directional easy-grip
- Three speed switch to control air flow thus fluid outflow
- Soft rubber probe tip with lateral eyes for less trauma and likelihood of blockage
- Large 3" (70mm) opening for easy filling and cleaning
- Bottle stands up on flat surface
- Probe bends at bottle via rubber connection so flow starts when desired

**J1317 Speedy Calf Drencher 2.5L**  
**J1317L Speedy Calf Drencher 4.0L**



**Speedy Calf Feeder.** Three-speed calf bottle was developed in New Zealand and is widely sold worldwide. It is especially useful for weak or premature calves that cannot nurse properly.

The Speedy Calf feeder features

- Simple switch has 3 "speeds" to adjust flows
- x-Fast for aggressive nursers
- x-Slow for weak calves: can take milk as they can cope
- Easy grip can be used comfortably in several positions
- Cap mounted low to help empty bottle completely
- Wide 3" diameter neck for easier filling and cleaning
- Capacity 2.5 liters
- Wide base lets bottle stand easy



**J1022 Speedy Calf Feeder**  
**J1022d spare teat only**  
**J1022d2 teat and cap assembly**

**Bovine Easy Drencher**

The use of old wine glass bottles for drenching cattle is a thing of the past. The Easy Drencher was developed in New Zealand and is used world wide for drenching.

- Easy grip handle
- 1.2 liter capacity/graduated in 100ml increments
- 12 cm long-safe nozzle
- Wide neck for easy of filling liquid or powders

**J1021 Bovine Easy drencher**, complete  
**J1021d1 extra probe**



J1021

*NOTE:* Even though this device was developed foremost for safety, care must be given to allow the animal to adequately swallow during drenching. If not, aspiration into the lungs can occur. Administer in the side of the mouth for correct probe placement.

**Leg Quickstraps.** Simple release – press a button. Quickstraps are the easiest of all leg straps to use and are most visible on a cow. The protruding end acts like a ‘flag’ waving on the cow’s leg. The quickstrap is removed by simply pressing on the release button. Use these bright colored straps for all temporary id needs. Quickstraps can be written on with an ear tag marking pen. For added safety we recommend using Quickstraps on both hand legs of antibiotic treated cows.



<b>J1314B</b> Blue	<b>J1314P</b> Pink
<b>J1314G</b> Green	<b>J1314R</b> Red
<b>J1314O</b> Orange	<b>J1314Y</b> Yellow



**Leg Bands.** Nylon, 10 pack. Hook and loop (Velcro) Nylon leg bands. Simply wrap around the cow’s leg and press together for quick temporary identification. To remove, grasp and pull. Easy to clean and re-use. Can be written on with standard tag marker. Top quality and extra wide. 33cm (13”) long x 5cm (2”) wide.



<b>J1313B</b> Blue	<b>J1313P</b> Pink
<b>J1313G</b> Green	<b>J1313R</b> Red
<b>J1313O</b> Orange	<b>J1313Y</b> Yellow
<b>J1313M</b> Mixed	



**Liftease Large Animal Sling.** The liftease is designed for medium term support for a downed cow. The cow is supported over a large body area, thus reducing pressure points. Full adjustable to any size animal.

- Open web design so animal’s skin can breathe.
- Durable — can support working load of 2,000 kgs.
- Multiloops on the webbing straps provide adjustment over large range of animal sizes.
- Soft felt slip sleeves on webbing straps go between hind legs and udder. This prevents chafing.
- Adjustable seat support fits between tail and udder to give extra support and comfort.
- Sling is packed in a drawstring storage bag.



The sling can be used on many tractor attachments like hay forks or front end loaders.



**J1318 Liftease Large Animal Sling**



**J0001 Electric Shocker.** This is the popular “Dutch” prod; a sturdy prod with a strong shock. Includes 2 “D” batteries. 9”L.

**J0001e Extension Handle** for electric shocker (**J0001**). Extends total length to 36”.



**Rumen Magnets.** The administering of rumen magnets to dairy cattle for the prevention of hardware disease is a common practice. .

**J0309h Cylinder Magnet** (hot dog style). This traditional style is solid metal with rounded ends. Features a polished metal finish with slightly roughened ends. Alnico style. 3”L. 12/box.

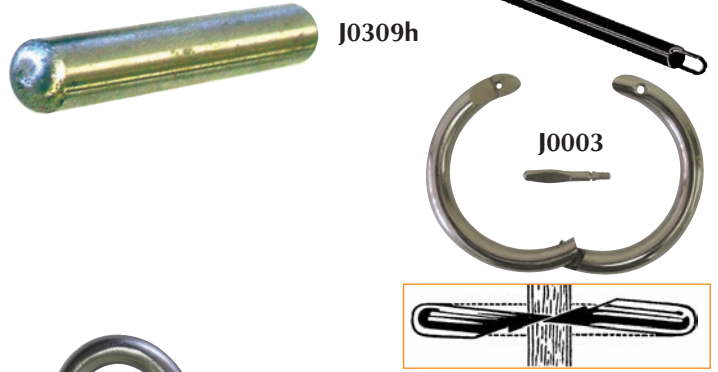

**J0003 Bull Rings.** 2 1/2” i.d. This new polished steel bull ring is much stronger than brass. The special sharp cutting points pierce the nasal septum easily with no pre-incision. Screw and screwdriver combined. Break screwdriver off after insertion.

**J0003c Bull Ring Copper-Brass.** 2 1/2” i.d. (not pictured)



**J0178 Bull Lead.** Spring-loaded lead closes in animal’s nose. Useful in moving or transport of animal. Nose piece measures 2” x 3” across center dia. Overall 5”L.

**J0178ab Bull Lead** without chain or hooks.

**J0178b Bull Lead** with chain. No hooks.

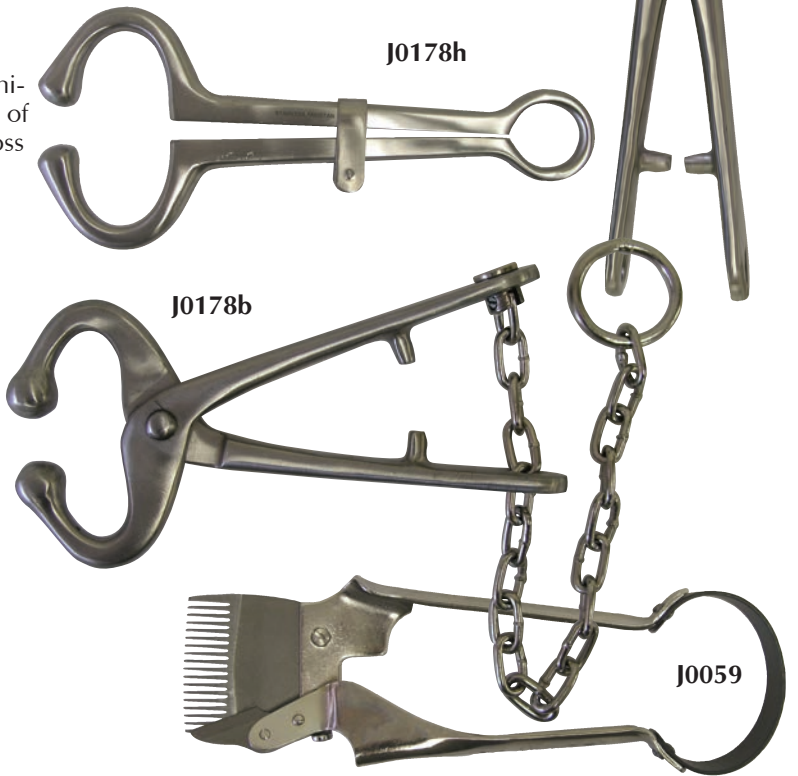

**J0178h Harm’s Style Bull Lead.** Stainless steel. Overall 10”L.

**J0059 Hauptner Hand Clipper.** Large animal. For clipping when no electricity is available.

**J0059d Extra Blades.**

**J0360 Sheep Trimming Shears.** Red enameled handles. 6” blades.

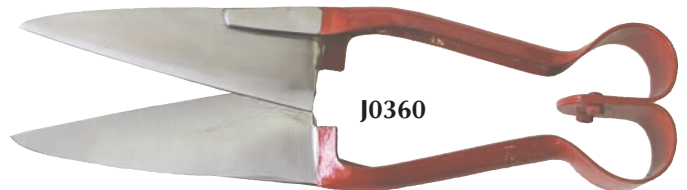

**J0361 JorVet Hog Holder** with lock for quick release. Designed for easy catching and holding of hogs. New cable design with stainless steel handle.

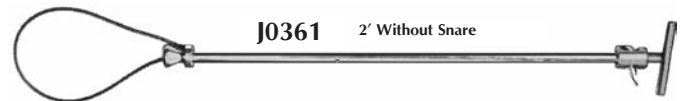

**J0155 JorVet Rectal Prolapse.** JorVet rectal rings are precision-machined acrylic plastic with tapered ends for easy insertion.



**Swine Ring.**

- J-155b Ring.** 5/8" x 2". Feeder. 24/pk.
- J-155c Ring.** 3/4" x 2". Large feeder. 24/pk.
- J-155d Ring.** 7/8" x 2". 40 lbs. 24/pk.
- J-155e Ring.** 1" x 2". <40 lbs. 24/pk.



**J0042h Pig Tooth Nipper.** Nickel-plated. 5 1/2"L.  
**J0042hs Pig Tooth Nipper.** Stainless steel. 5 1/2"L.



**J0056 Sterile Umbilical Clamp** helps prevent navel infection. Self-locking; disposable plastic. Single.

**J-56b Umbilical Clamps,** bulk. 50/pk.



**J0056ha Huston Swine Hernia Clamp.** 5".  
**J0056hb Huston Swine Hernia Clamp.** 7".

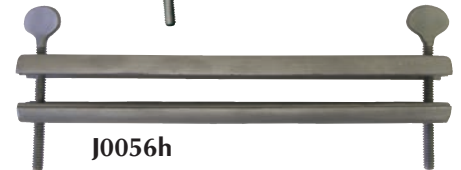

**J0056g Hernia Clamp** for umbilical hernia. Aluminum. 14cm.

**J0182 Barne's Dehorner.** 12".



**J0182m Dehorner.** Heavy-duty dehorner. Steel handles with rubber grips. Heat-treated steel cutting blades. 17".

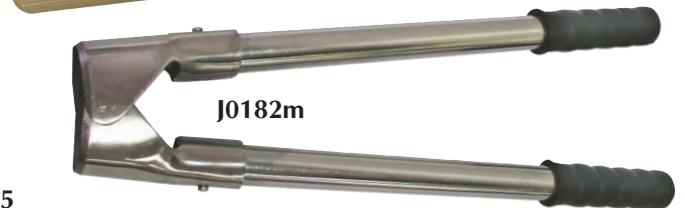

**J0095 Jones Artery Forceps.** Used in dehorning for pulling the cornual artery. 5".



**Farmhand Geared Dehorner.** Designed for mature stock with fully grown horns. Vastly improved design of the familiar heavy duty dehorner, use these and you will never go back.

- Precision cast from high grade stainless steel vs. sand cast iron. It is corrosion resistant.
- Main pivot point for the handles are fitted with friction reducing bushings to further enhance the cutting action which reduces effort necessary to operate.
- New eccentric design provides maximum leverage at the initial part of cutting stroke reducing the effort required.
- Light weight 6kgs vs. standard 8kgs.
- Handles and blades are available as spare parts.
- Blade opens up to 9cm (3.6").

Length 115cm (46"); Handle 70cm (28")

- J1311 Complete dehorner**
- J1311d1 Extra set of blades**
- J1311d2 Extra set of handles**



**J0101 Anal Sac Excision Kit.** The anal sac excision kit employs a warm liquefied gel injected in to the sac. The gel is in a 2ml cartridge that is first heated to a liquid and loaded in a specially designed syringe. Then, via a 19g blunt needle, is injected into each anal sac. The gel then hardens and gives the sac a readily defined and easily dissected shape for quick removal.

Each kit has enough material to do up to eight animals and contains:

**J-101d#1 Metal Breech Loading Syringe.**

**J-101d#2 Gel Vials.** 8 x 2ml.\*

**J-101d#3 Blunt Needles.** 8 x 19g.\*

\* Refill packs available. Packs interchange with any existing kit on the market.

J0101



**J0115 Gastric Lavage Kit.** A kit designed for use in common gastric emergency conditions where quick and effective lavage or flushing of the stomach is required, (e.g. gastric dilatation volvulus and acute poisonings). The kit includes 3 large bore semi-rigid lavage tubes and a stomach irrigation system that connects to any faucet.

**Kit contains.**

- (3) Semi-rigid polyethylene tubes
  - 1" i.d. x 1 1/4" o.d. 48"L.
  - 7/8" i.d. x 1" o.d. 42"L.
  - 5/8" i.d. x 3/4" o.d. 36"L.
- Dura clamp to prevent backflow
- Reducing clamp
- Faucet adaptor
- PVC tubing 3/8" i.d. x 1/2" o.d. x 100cm
- Stomach tube with metal X-ray marker 23cm x 76cm.

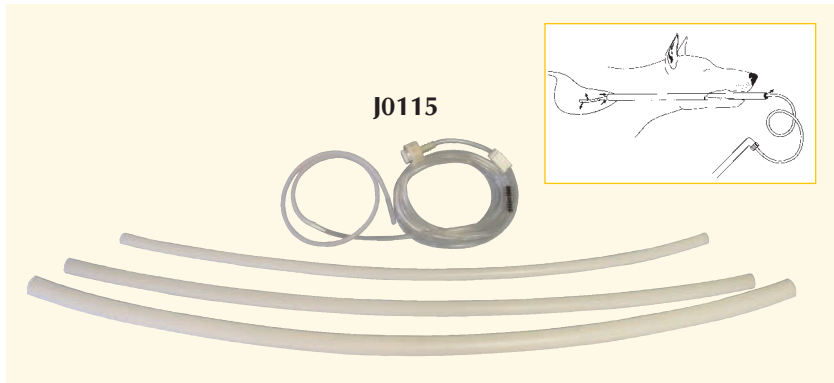

**Ameriod Constrictors.** For the surgical treatment of porto caval or hepatic shunts.

This specially designed product is used to encircle a blood vessel. A special material (hygroscopic compressed casein) inside the donut shaped constrictor imbibes fluid over time. It slowly occludes the blood vessel.

A small key is used to lock it in place after it is slipped over the blood vessel.

Sizing: about a 25% reduction in the blood vessel diameter should be achieved upon initial surgical placement for the best results. Sterile.

	Diameter of inner circle
<b>J0659</b>	3.5mm
<b>J0659a</b>	5.0mm
<b>J0659b</b>	6.0mm
<b>J0659c</b>	6.5mm
<b>J0659d</b>	7.0mm

Other sizes available

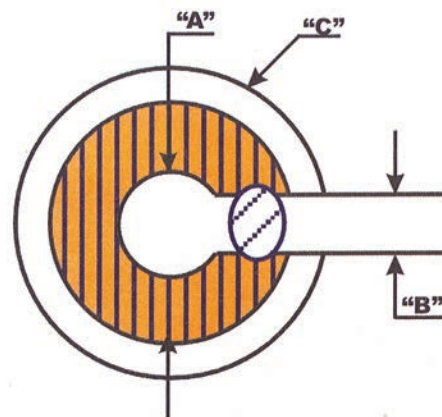

**NOTE: DO NOT AUTOCLAVE. GAS STERILIZATION ONLY.**



**Transparent Lexan® Thoracic Positioner.** Lightweight and easy to clean. V-shaped trough. Slightly elevated to help drain fluids away from patient. Radiolucent

- J0279a** **Small Dogs and Cats.** 7"W x 8"L x 2"H.
- J0279b** **Medium Dogs,** up to 40 lbs. 8"W x 10"L x 2 1/4"H.
- J0279c** **Large Dogs,** up to 60 lbs. 9"W x 14"L x 3"H.
- J0279s** **Set of 3 Positioners.**



**J0279t** **Tomcat Positioner.** Great positioner for restraining male cats and exposure of perineal area. Good for working with urethral obstructions and for neutering. No tie-downs or other assistance necessary. Lightweight and adjustable.

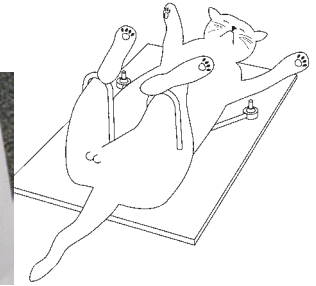

**The Lone Star Veterinary Retractor System** consists of two components, the autoclavable plastic ring and the accessory elastic stays. Because of its unique design, the retractor ring easily can be adapted to the patient's anatomy. The elastic stays allow the surgeon flexibility over the amount of tension applied and precise retraction of the incision without obstruction. Prep and drape patient in usual manner, then apply the retractor.

**Green Autoclavable Plastic Rings.** Provided sterile.

- J4405** **Rings.** 27.5cm x 14.2cm. The middle piece can be removed to shorten its size.
- J4407** **Rings.** 14.2cm x 14.2cm. *Stays must be purchased separately.*
- J4411** **Elastic Blue Silicon Stays** with single hook, 8/pk. Sterile. Not autoclavable, but use cold or ETO sterilization for reuse.

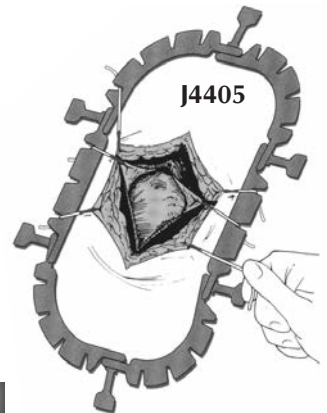
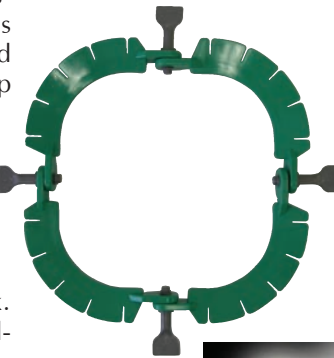

- J1115** **Touchless Faucet Adapter.** Hands Free!!
  - Infrared sensor turns on water with wave of your hand
  - Touchless activation prevents contamination
  - Auto shutoff reduces water usage
  - Easy to install on about every existing faucet
  - Includes manual override
  - Works on 4AA batteries (not included)



**Vac-U-Lok Animal Positioners.** The **Vac-U-Lok Positioner** conforms gently to the natural contours of the patient's body. A vacuum pump removes air from inside the positioner to give a comfortable, but secure and consistent positioning support.

**NEW**

**Indicators for secure positioning:**

- Ultrasounds
- MRI/CT Scan
- Surgery
- Dentistry
- Radiographs

*Note: A portion of every sale goes to the Colorado State University Veterinary Oncology program.*

**Features:**

- Light Weight:** easy to move to any location
- Conserves Body Heat:** reduces hypothermia conditions
- Easy to Clean:** just wipe down with mild soap and water
- Reusable:** if it happens to tear, it can be readily patched
- Product Make-Up:** • Polystyrene 'bean bag' beads in light blue nylon sealed pouch. • Air valve allows for vacuum of air to give stable positioning.

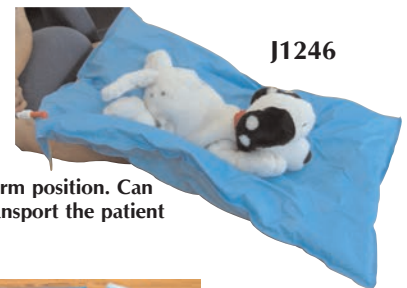

- J1246** **Large Vac-U-Lok Positioner.** 28" x 39" (70cm x 100cm)
- J1246a** **Medium Vac-U-Lok Positioner.** 20" x 208" (50cm x 70cm)
- J1246p** **Dual Action Pump** for vacuum

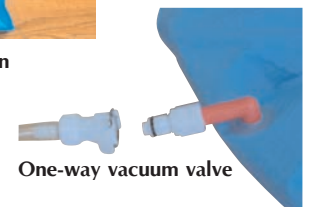



**Hemastop.** Veterinary styptics became necessary when the first nail trim started bleeding. Use on

bleeding nails, beaks, skin, or any external minor bleeding. Hemastop is a combination of two proven styptic compounds:

- Ferric subsulfate powder – industry standard
- Petrolatum gel – used in the sport of boxing as a safe and pain free styptic for years.

Both compounds are combined in a familiar 'Chapstick' type screw end dispenser with a protective cap.

Economy – one tube has a large multitude of applications  
 Ingredients – soy wax, petrolatum, ferric sulfate, diatomite  
 Patent pending

**J1257 Hemastop.** 3 tubes per pack



Bleeding bird nail about to be treated with HemaStop



Bird nail bleeding controlled by HemaStop



For heavy bleeding, blot first



HemaStop controlling bleeding of dog nail

**Surgical Mesh** is a great solution for soft tissue repairs such as perineal and umbilical hernias in all species. Braun has a tested range of surgical mesh that is used extensively in human surgery world-wide.

- nonabsorbable in two materials
- absorbable

All three types come in a range of sizes to cover small to large needs in single sterile packs.

**NEW**

**Premilene® Mesh** is thin, soft, smooth and strong. The mesh of choice for larger hernia repair.

- Made from Polypropylene Monofilament, nonabsorbable
- Smaller pore size
- Can be trimmed with no fraying
- Thin mesh: transparent, can see underlying tissues
- Suitable for minimally invasive techniques

Specifications:

Knitted

Weight 82g/m<sup>2</sup>

Thickness 0.48mm

Pore Size 0.8mm

**J1249a Premilene® Mesh** 7.5cm x 7.5cm

**J1249b Premilene® Mesh** 5.0cm x 10.0cm

**J1249c Premilene® Mesh** 26.0cm x 36.0cm

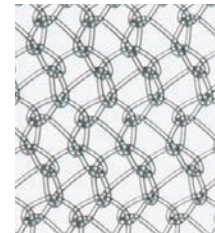
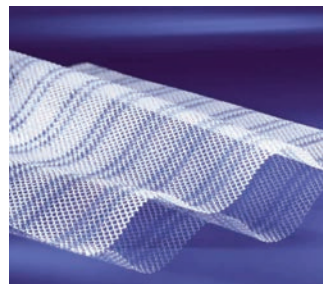

**NEW**

**Optilene® Mesh.**

- Monofilament Polypropylene nonabsorbable
- Larger pore size
- Blue guidelines in material helps proper placement
- More elastic mesh
- Can be used on minimally invasive surgeries

Specifications:

Weight 60g/m<sup>2</sup>

Thickness 0.53mm

Pore Size 1.5mm

**J1247a Optilene® Mesh** 5.0cm x 10.0cm

**J1247b Optilene® Mesh** 20.0cm x 30.0cm

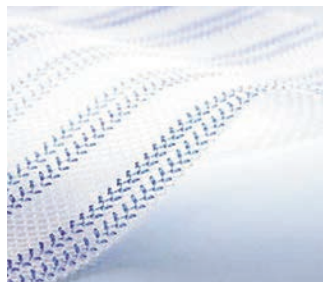

**NEW**

**Safil® Mesh.**

- Braided Polyglycolic Acid (PGA) **absorbable**
- Completes degradation by hydrolysis within 60-90 days

Specifications:

Weight 43g/m<sup>2</sup>

Thickness 0.53mm

Pore Size 1.4mm

**J1248 Safil® Mesh** 5.0cm x 6.0cm

**J1248a Safil® Mesh** 8.0cm x 12.0cm

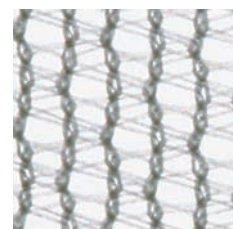

**LED Headlight.** The LED light source mounted in front of the loupes provides unobstructed, shadow-free illumination important for precision procedures. The LED lamp comes standard with a battery pack, and an optional A/C power cord is available for continuous bench use. LED light can be used with LW Scientific loupes, any other loupes, existing glasses, or just by itself.

Optional magnifying lens attaches just below light

	Magnifying lens	x	Working distance
<b>J1036d1</b>	1.50	x	20"
<b>J1036d2</b>	1.75	x	14"
<b>J1036d3</b>	2.25	x	8"
<b>J1036d4</b>	2.75	x	6"

**J1036 LED headlight on headgear.** 3 AAA battery pack (included). Padded with real leather for extended comfort. Adjustable headband. Overhead strap. Convenient knobs adjust for your head size. 100 lumens, 100,000 hours.



**Operating Loupes.** The new and improved Loupes from Jorgensen Laboratories feature more ergonomic, lightweight sport frames, as well as higher-resolution, scratch-resistant, anti-glare glass optics. Using loupes reduces eyestrain and fatigue and improves quality and patient care. The flip-up optics and QUICK-WIDTH adjustment makes these loupes more comfortable to wear and easy to share. The 2.5x loupes are recommended for most users and especially beginners, because the wide field of view and huge 3-D depth of focus makes them easy to work under. The economical price is affordable for any veterinary technician and the quality is up to the standards of surgeons and doctors.

- Razor sharp, edge-to-edge clarity
- Extremely high resolution reduces eye strain
- Ultra light weight for superior comfort
- Ergonomic design improves working posture

**J1138v Variable Loupes:** a good choice as they have zoom magnification and variable working distance.

- Zoom magnification 2.5x to 3.5x
- Variable working distance 440mm to 250mm
- Variable depth of field 130mm to 50mm
- Variable field of view 100mm to 400mm
- Weight 2.5oz

**J1138c Clip-on Loupes — 3.5x.** Already use prescription glasses? Then the clip-on loupes are designed for you. Works on most prescription glasses.

- 3.5x magnification
- Working distance 375±10mm
- Depth of field 40mm
- Field of view 60mm
- Weight 2.4oz

**J1138b Clip-on Loupes — 2.5x** magnification.

**Premium Loupes** include case, cleaning cloth, flip paddle, lanyard and optical lens protector caps. Stylish sport frames with comfort gel nose bridge. One turn interpupillary adjustment.

**J1138ps Premium Loupes, magnification 2.5x,** Short 330mm working distance, depth of field 50mm, field of view 100mm, weight 2.5 oz., black frames.

**J1138psw Premium Loupes, mag 2.5x.** Long 490mm working distance — BEST SELLER!

**J1138pl Premium Loupes, magnification 3.5x,** Short 330mm working distance, depth of field 50mm, field of view 44mm, weight 2.9 oz, red frames.

**J1138plw Premium Loupes, mag 3.5x.** Long 490mm working distance. Not pictured.



**Accessories for loupes:**

**J1036d5 Clip-on LED.** Movable light puts light where you need it. LED Light for 10,000 working hours. Extra-bright, daylight white LED. Includes belt-clip battery pack.

**J1036d6 AC Power Adapter for LED light.** 110v transformer.



**Optivisor®.** OptiVisor is a precision binocular headband magnifier which permits unrestricted user efficiency—leaving both hands free, while reducing eye strain—allowing three dimensional vision. It can be worn over prescription eyeglasses. Equipped with these unique features:

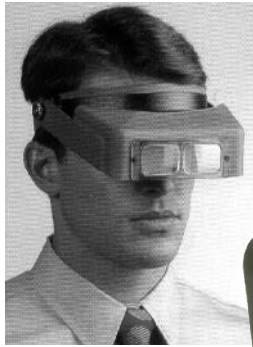

Hands-Free Magnification with Adjustable Headband.

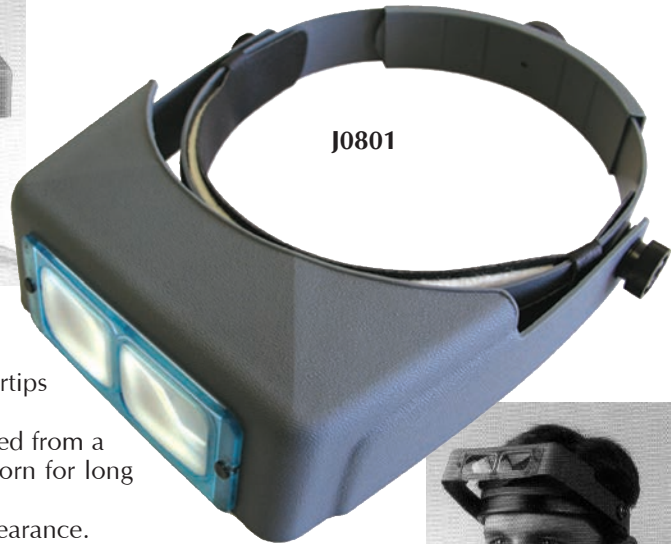

Visor Tilts Up for Normal Viewing.

- Optical glass prismatic lenses. Ground and polished to precision optical standards. Bevel edged and mounted in interchangeable plastic frame.
- Adjustable pivots allow the visor to be tilted out of the way when not in use, and at your fingertips when magnification is needed.
- Adjustable headband conforms to fit all head sizes. Fabricated from a special blend of lightweight material. Comfortable when worn for long periods of time.
- High impact visor is tough, durable, and always new in appearance.
- Genuine leather comfort band is padded with orthopedic felt to add comfort.
- Magnifies 2.5 times at 8".
- Optivisor is perfect for eye exams, (i.e. corneal foreign body, distichiasis).

Varying magnifications and focal lengths available:

- J0801** **Optivisor.** 2.50x at 8" (most popular).
- J0801b** **Optivisor.** 1.75x at 14".
- J0801c** **Optivisor.** 2.00x at 10".
- J0801d** **Optivisor.** 2.75x at 6".
- J0801e** **Optivisor.** 3.50x at 4".
- J0801v** **Visor Head Light.** Provides hands-free light where you need it. Pack mounted on head band. Xenon laser beam emits 6000 candle power. Operates ~5-6 hours with 2 AA batteries.
- J0801vd1** **Replacement Bulb,** 2 pack.



**Optiloupe®.** An attachable lens that adds the additional power of an eye loupe to the Optivisor.

- Designed for monocular use and easily flips up or down providing additional 2<sup>1</sup>/<sub>2</sub>X magnification.
- Easily attached to either eye of Optivisor.

**J0801L** **Optiloupe.**

**Replacement Lens Plate.** Only for optivisor. These lenses interchange by removing two screws. (not pictured)

<b>J0801Lpa</b>	<b>Lens Plate.</b>	1.5 Magnification	20" Focal Length	2
<b>J0801Lpb</b>	<b>Lens Plate.</b>	1.75 Magnification	14" Focal Length	3
<b>J0801Lpc</b>	<b>Lens Plate.</b>	2 Magnification	10" Focal Length	4
<b>J0801Lpd</b>	<b>Lens Plate.</b>	2.5 Magnification	8" Focal Length	5
<b>J0801Lpe</b>	<b>Lens Plate.</b>	2.75 Magnification	6" Focal Length	7
<b>J0801Lpf</b>	<b>Lens Plate.</b>	3.5 Magnification	4" Focal Length	10





**EN Snare® Endovascular Snare System.** For the surgical treatment of the heartworm caval syndrome. The heartworm caval syndrome is a life-threatening manifestation of canine heartworm disease. A large number of adult heartworms in the great vessels in or around the heart led to severe pulmonary hypertension. The patient requires immediate surgery with the most common procedure being the tranvenous heartworm extraction.

The EN Snare endovascular system is intended for use in the jugular vein. It consists of three interlocking loops.

- The EN Snare is designed to expand to vessel wall size for retrieval of hard to get side-walled objects.
- The EN Snare is designed with three loops to increase the probability of foreign body capture.
- Interlaced Nitinol loops provide structural integrity when capturing objects.

**J1256 EN Snare 6fr x 120cm**

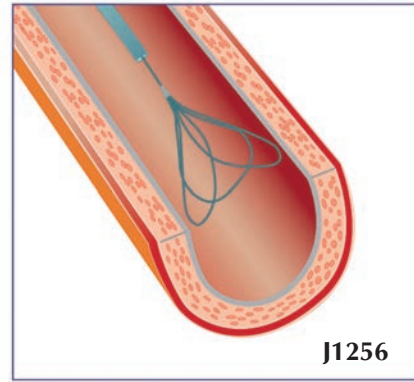

**BUSTER DogMaze** is an innovative and fun way to feed your dog. Once filled with dry kibble it becomes a food bowl, a mentally stimulating toy and doggie entertainment center all rolled into one! Patent Pending.

Mentally stimulate your pet. Throw away the bowl, introduce the BUSTER DogMaze and start making your pet earn his food for himself!

Prevent Food Bolting. The average dog takes at least four times longer to finish his regular meal when fed through BUSTER DogMaze. Slowing down your dog's eating may be beneficial to his health.

**J1114r Grey**  
**J1114s Beige**  
**J1114t Black**

To see the BUSTER DogMaze in action watch the movie at <http://www.youtube.com/watch?v=> or [www.JorVet.com](http://www.JorVet.com). Get your free copy on DVD with the purchase of a display box.

The **BUSTER DogMaze** also comes in a convenient display box with 4 units of each color. Perfect for displaying in waiting rooms.

**J1114V Display pack (12 bowls)**



**DogMaze: The toy that thinks it's a bowl!**





**Aural Hematoma Pad.** Aural hematomas are a common clinical case. A pocket of blood develops a separation between the inside skin of the ear and the ear cartilage. Surgical treatment is directed towards restoring that skin to cartilage bond.

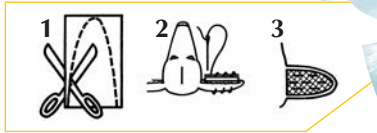

J0047

**Overview of the Procedure:**

1. The 12cm x 18cm pad is trimmed to fit the inside size and shape of the affected ear.
2. The ear is surgically prepped in normal fashion.
3. A 1-2cm straight longitudinal incision is made into the hematoma.
4. The hematoma is drained.
5. The compress pad is pressed into place against the incision and hematoma.
6. The compress pad is held in place by approximately eight sutures in a horizontal mattress pattern.

**J0047 Buster Aural Hematoma Pad** provides a compression pad that gives good ventilation and great cosmetic results. The pad consists of an inner open soft foam layer and one tougher outer surface where sutures are placed. Sterile.

**Ultrasound Gel.** An aqueous coupling gel for both diagnostic and therapeutic procedures (i.e., ultrasound or doppler).

**J0554 Ultrasound Gel, 9 oz. Dispensing Bottle.**  
**J0554b Ultrasound Gel, 5-Liter Bulk Jug.**

J0554



**J0312q Ultraviolet Wood's Light.** A hand-held lamp with 110V plug-in. High impact plastic housing.

- Ultraviolet light at wavelength of 365nm with intensity of 180uW/cm<sup>2</sup> at 6"
- 7<sup>5</sup>/<sub>8</sub>" x 2<sup>7</sup>/<sub>8</sub>" x 2". 1 lb.
- 4-watts

**J0312qb Replacement Bulb.**

**J0312s Ultraviolet Wood's Light.** Uses 110V plug-in.

- Ultraviolet light at wavelength of 365nm
- 14<sup>9</sup>/<sub>10</sub>" x 3<sup>9</sup>/<sub>10</sub>" x 2<sup>1</sup>/<sub>2</sub>". 2 lbs.
- 6-watts

**J0312sb Replacement Bulb.**

**J0312m Portable Woods Light.** Ultraviolet light (blacklight) used in the diagnosis of certain fungal or ringworm (Microsporum Canis) infections that will fluoresce green. Small and portable. Uses 4 x AA batteries (not included). 7 oz. 2<sup>1</sup>/<sub>2</sub>" x 6<sup>1</sup>/<sub>2</sub>".

**J0312b Replacement Bulb.**

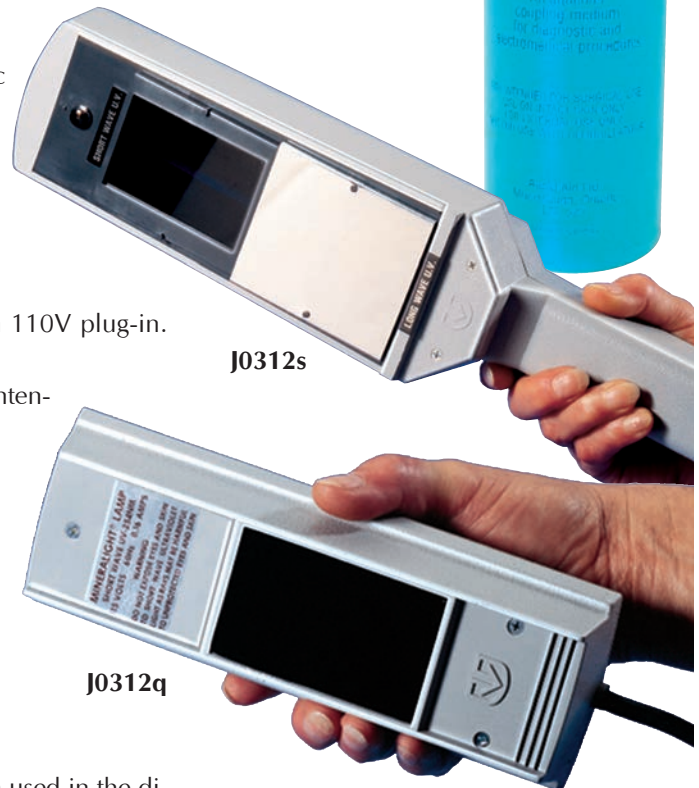

J0312s

J0312q

J0312m



**JorClave Solution.** Foaming Autoclave Cleaner. The steam autoclave is a work-horse in today's veterinary clinic. Its heavy use even with distilled water results in dark brown scale deposits on the inside chamber. If not regularly cleaned, these deposits will foul the surgical pack and affect the performance and longevity of the autoclave. It is recommended to clean the autoclave after every 20 cycles, or once per month if used everyday.

The JorClave foaming autoclave cleaner will remove all rust spots, stains, and corrosion. In addition scale, alkaline and mineral deposits on the inside chamber walls of autoclave. It also works well on stainless steel carts, trays, or surfaces.

- Mild acidic solution removes rust, stain, spotting, and corrosion
- Most other solutions are slightly alkaline, but the actual deposits are alkaline in pH.
- Foaming action stays on surface longer than standard liquid spray
- Pump spray goes on easily and quickly
- Restores original finish
- No more noxious odor from walls of autoclave

**J0646 22 oz. Pump spray bottle**



**J0646**

**J1273d Hook Disgorger 10mm x 800mm**

**Esophageal Foreign Body Forceps.** One day you will need these!! An especially long forceps that can remove foreign bodies such as fish hooks or lodged bones from even the distal esophagus or trachea.

- backward facing teeth for maximum grip
- shaft diameter small as possible to allow placement of endoscope alongside

**J0212ef 23" shaft length (57.5cm) x 7.5mm/6mm diameter.** Extra long forceps (total length including handle is 27" (67.5cm)). Diameter jaws 13mm x 9mm. Maximum jaw gap is 30mm.

**J0212efa 50cm shaft x 4.2mm diameter**

**J0212efb 25cm shaft x 3.0mm diameter**

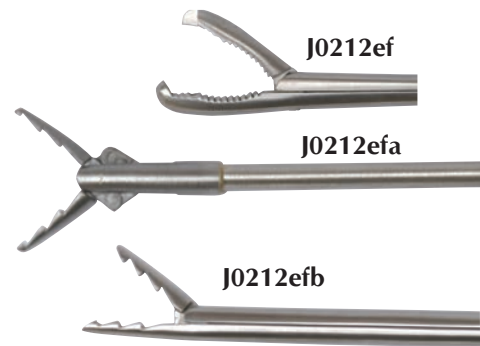

**J0212 series**

**Feline Declaw forceps.** These forceps are very useful in feline declaws especially when doing the procedure with a laser. The wide end grabs the claw firmly so a precise incision can be made. Stainless steel. German.

**J1026 small 4"**

**J1026a large 5.5"**

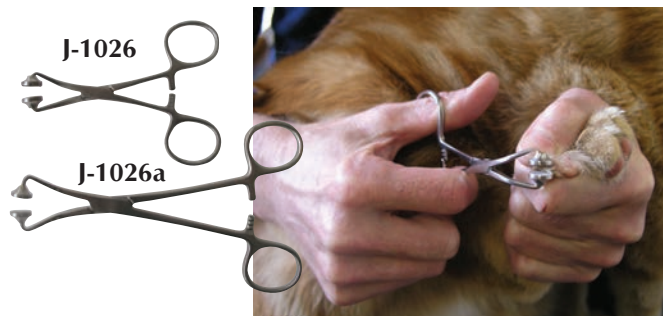

**Laser Consumable or Replacement Parts** for use with the AccuVet LX-20 CO<sub>2</sub> Laser System. JorVet offers these commonly needed parts for the operation of the CO<sub>2</sub> Laser. These parts are warranted to be identical in quality to any factory part, are shipped non-sterile and can be repeatedly re-sterilized. *All laser tips are compatible with Lumenis/Luxar LX-20 Handpieces and the Aesculight™/LuxarCare™, LightScapel™ handpieces.*

The recently introduced "T-Series" offers a vastly improved ceramic tip which employs a Teflon™ coating. The coating significantly reduces spatter buildup on the outside and inside of the tip, resulting in cleaner cutting and less tissue charring. The color-coded Teflon™ coating on the distal tip provides: • Positive tip size identification • Easier to clean surfaces • Full insertion indication • Can be repeatedly autoclaved.

- J0941 Ceramic Laser Tip.** 5mm long x 0.8mm spot size. (Luxar C5 equivalent) Shorter tip for tight access applications. **5/pk.**
- J0941a Ceramic Laser Tip.** 10mm long x 0.8mm spot size. (Luxar C10 equivalent) Versatile tip for most applications and can be used for laser system calibration. **5/pk.**
- J0941ta Ceramic Laser Tip with Teflon Coating.** 10mm long x 0.8mm spot size (Luxar C10 equivalent). Versatile tip for most applications and can be used for laser system calibration. *Teflon coating reduces spatter buildup that can degrade laser beam quality.* **5/pk.** (Blue Teflon™ coating)
- J0941b Ceramic Laser Tip.** 10mm long x 0.4mm spot size (equivalent to Luxar metal tips LXT-010SS, LXT-010SSD and "Gold Tip") Small spot size offers the ability to do narrower incisions and with increased power density. Handles higher powers than metal tips. **1/pk.** (One green stripe indicates 0.4mm spot size.)
- J0941tb Ceramic Laser Tip with Teflon Coating.**
- J0941c Ceramic Laser Tip.** 10mm long x 0.2mm spot size (equivalent to Luxar metal tips LXT-010XSS). Smallest spot size available. Offers the ability to do very narrow incisions and with increased power density. Handles higher powers than metal tips. **1/pk.** (Two green stripes indicates 0.2mm spot size.)
- J0941tc Ceramic Laser Tip with Teflon® Coating.** 10mm long x 0.2mm spot size (equivalent to Luxar metal tips LXT-010XSS). Small spot size offers the ability to do narrower incisions and with increased power density. Handles higher powers than metal tips. *Teflon coating reduces spatter buildup that can degrade laser beam quality.* **1/pk.** (Purple Teflon™ coating indicates 0.2mm spot size.)
- J0941x Large Spot Tip.** New larger size for ablation and hemostasis. 1.4mm x 5mm length. Aluminum material.

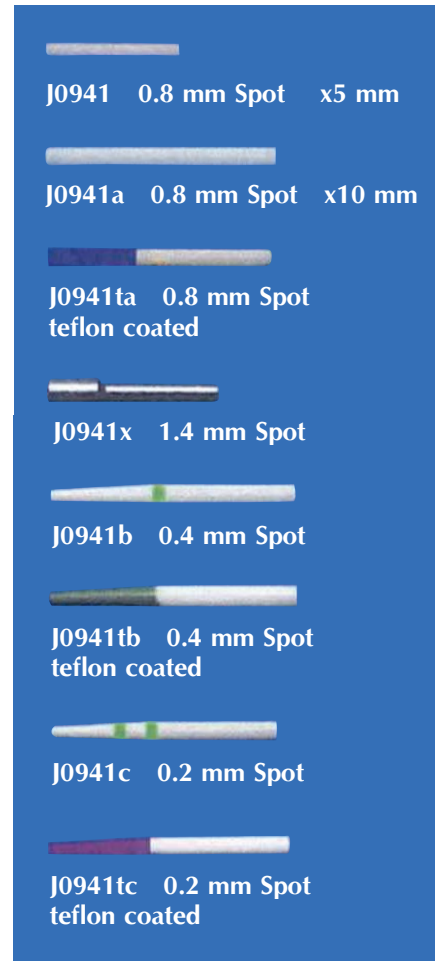

Luxar Laser





**Necropsy Knives.** These high quality molybdenum-hardened stainless steel bladed knives come with a yellow nylon no-slip grip handle. German-made.

- J0502a** **Necropsy Knife.** Wide blade. 5".
- J0502b** **Necropsy Knife.** Wide blade. 7".
- J0507a** **Necropsy Knife.** Narrow blade. 5".
- J0507b** **Necropsy Knife.** Narrow blade. 7".
- J0513** **Curved Boning Knife.** 6".
- J0515** **Necropsy Knife.** Curved. 6".

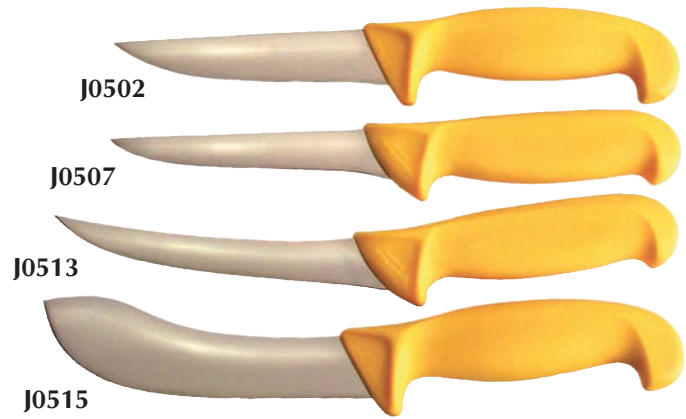

- J0902** **Steel Sharpener.**



- J0902s** **Stone Sharpener.** (not pictured)

- J0902dm** **Diamond Sharpener.** Medium. Comes with leather case.

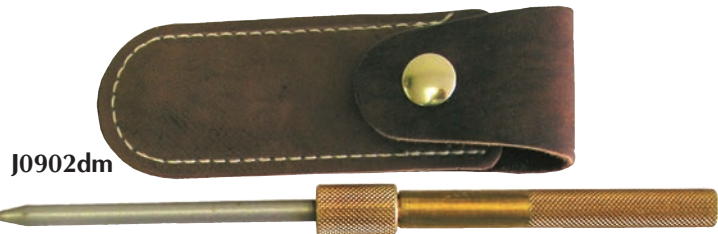

- J0902ds** **Diamond Sharpener.** Small for easy carrying in a shirt pocket.



- J0075n** **Postmortem Scissor.** Heavy-duty scissors with one serrated edge and black finished rings. 2" cutting blade. 7<sup>3</sup>/<sub>4</sub>"L.



- J0508** **Rib Shear.** Cuts through rib cage on small animals and younger large animals. German-made. Stainless steel. 9" length.



**Ketogel™** is a concentrated energy gel packed with vitamins, amino acids, and trace minerals. It is designed to be used to help maintain normal blood glucose (sugar) during periods of stress (i.e., difficult calving and metritis). This stress period often leads to ketosis (acetonemia). The administration of an oral product often is a follow-up to an intravenous treatment of dextrose or glucocorticoids.

- **Energy Source.** Ketogel™ provides 290 grams of propylene glycol. This is rapidly absorbed directly from the rumen to the liver and converted to glucose.
- **Vitamin A** (40,000 Units), **Vitamin D** (10,000 Units), **Vitamin E** (100 Units). The ruminant is unable to synthesize these vitamins. There is an increased demand during periods of stress.
- **Niacin** (6 Grams) has a role in increasing glucose production and decreasing fat mobilization.
- **Choline** (6 Grams) and **Methionine** (6 Grams) are methyl group donors and have an important role in the regulation of fat deposition in the liver.
- **Cobalt** is a precursor of Vitamin B12. This is an important co-factor in glucose production.

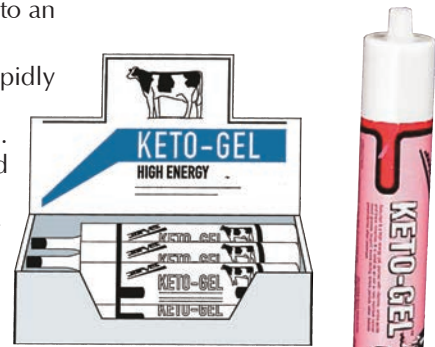

J0306

**J0306 Ketogel™.** 12/display case.

**J0294 Cal-Gel™ (Respond)** is a specially-formulated mineral supplement for use in dairy cows. It is an aid to maintaining normal calcium levels during the critical immediate pre-partum and post-partum periods. Cal-Gel comes in a standard dosing cartridge and is administered orally. Based on a Danish formulation used for over 20 years it delivers calcium together with magnesium and cobalt at a balanced pH. 12 cartridges/display case.



**J0294g Cartridge Dosing Gun.**

**J0349 Bovine Colostrumeter.** The JorVet colostrumeter measures IgG content in a simple cow-side test. The graduated cylinder is filled with a few ounces of Bovine colostrum. The colostrumeter is gently inserted and floats to a level indicating the colostrum IgG content. A University of Florida study found only 20 percent of colostrum contained an adequate amount of IgG for good calf health. Plastic.



J0294

**J0330ec First Colostrum.**

- Now USDA approved for protection against E-Coli, K-99 antigen
- USDA approved for failure of passive transfer
- Still real colostrum. Not a substitute like cheese whey or blood plasma
- Powder form in foil-lined pouch of 350 gm
- Now with up to 3-year dating
- Detailed literature upon request
- 12 pk/display box



J0349

Protects Against E. Coli!



J0330ec

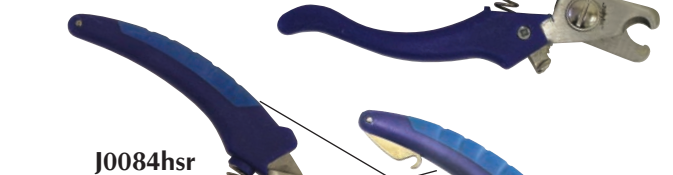

**J0084 White's Toenail Scissors.** 4".

**J0084g White's Toenail Scissors.** German-made. 4".

**J0084c Cat Claw Scissors** specially designed for cutting the thin and fragile nails of cats and small exotics. Gives a good clean cut without tearing or shredding. Stainless steel. 3" (7.5cm).

**J0391 Bird Nail Trimmer.** The very small nails of birds require delicate trimming to avoid bleeding or injury. Other trimmers are simply too large to do a proper job. Stainless steel notched blades. 10cm L.

**J0307 JorVet Guillotine Style Nail Trimmer.** One size fits all. Has no-slip handles and special shield for protecting the blade during storage. 3/8" opening on the cutting jaw. 5".

**J0307d1 Spare Blade.**

**J0602 Two-Sided Nail File.** This nail file helps eliminate concerns of cutting nails too short or into nail quick. The nail is first cut with a trimmer then filed down to desired length. 6"L.

- Rounded concave surface. The inside coarse blade shortens nail length, while the outside fine blade smoothens nail
- Non-slip handle
- Packaged in attractive blister pack for display

**J0084h Heavy-Duty Nail Scissors.** A must for trimming nails of bigger breeds. Nylon handle. Blade opening 7/16" with safety lock. Stainless steel blades. 6 1/2"L.

**J0084hs Small Heavy-Duty Nail Trimmer.** Smaller and lighter version of **J0084h**. Safety lock opening 5/16". Perfect for small and medium-sized breeds. 5".

**New Style Nail Trimmer.** These trimmers have an attractive raised colored rubber insert in the hand. This new design has a firmer comfortable grip with a professional look. Also features a safety lock at handle bottoms. Light blue with dark blue rubber inserts. Packaged in resealable pouch.

**J0084hr Trimmer.** 6 1/2"L.

**J0084hsr Trimmer.** 5 1/2"L. Lighter and smaller version.

**Diamond-Paw.** *The Ultimate Diamond Nail Grinder.* This patented nail grinder will smooth and round any nail in seconds giving a professional appearance appreciated by the client and patient.

- Concave shape fits over the end of the nail
- Diamonds: nickel blended diamonds are in the inner wall, the most durable and hardest cutting particles available
- Stainless shaft fits any standard motorized hand tool

In 2-3 seconds the nail will be a beautiful, smooth, and round surface with no jagged or sharp edges.

**J1299 Standard Diamond Paw** 5/16" OD

**J1299a Large Diamond Paw** for over 40 lbs, 3/8" OD



Jorgensen Labs offers a variety of **Stains** that are simple and easy for in-clinic diagnostic purposes. The highest grade of reagents is employed to give consistent and high-quality stained slides.

JorVet stains are available in convenient kits or in large bulk refills. The stains listed below are the inventory every veterinary clinic should have for a basic in-house clinical pathology lab.

**JorVet Dip Quick Stain** is excellent for use in blood cell differential counts or as a general cytology stain, and gives coloration similar to the standard Wright-Giemsa stain. The rapid 3-step procedure can be done right in the wide-mouth 180ml. container in 15 seconds.

**J0322 Introductory Kit.** Includes one wide-mouth bottle (180ml) of each of the 3 different components.

**J0322a 500ml Refill Kit.** 500ml of fixative, eosin and counter stain.

**J0322a1 Fixative.** 500ml

**J0322 Series**

**J0322a2 Eosin** Red stain. 500ml.

**J0322a2g Eosin Stain.** Red stain. Gallon.

**J0322a3 Counter Stain.** Blue stain. 500 ml.

**J0322a3g Counter Stain.** Blue stain. Gallon.



*NOTE: These components may interchange with other brands of 3-component differential stains.*

**J0323 JorVet Gram Stain Kit.** An important stain that has a multitude of uses, i.e., a quick diagnostic check on a swab from a severe otitis or a stain from an isolated culture. 4 x 250ml bottles. Individual components available.

*NOTE: Gram Stain method does not allow the microscope slide to be dipped right into each bottle of stain.*

**J0323**



**J0324 New Methylene Blue.** This stain has many veterinary applications, from reticulocyte count to estrus vaginal smears. 250ml.

**J0324a Dispensing Bottle.** 2 oz. (not pictured)

**J0325 Sudan III Fecal Fat Stain.** A quick diagnostic test is to use Sudan III stain as an aid in the assessment of maldigestion/malabsorption syndromes. The Sudan III will selectively stain lipid droplets orange on a fecal smear. 250ml.

**J0326 Potassium Hydroxide (KOH) 10 Percent.** Useful in dissolving keratin and other debris when examining a slide for fungal components. 250ml.



**J0325fm** **Lugol's Iodine**, Stain Concentration. Useful in identifying difficult to see parasites on fecal floatation or wet mounts. These include protozoan parasites like Giardia, Coccidia, and also helminth parasites. This stain is picked up readily by protozoan nuclear structures and also stains their glycogen masses. Some parasites, like Giardia are very difficult to view unless stained in this manner. 500ml with 4 oz. dropper bottle. 2.1% Iodine Stain. 500ml.



**J0326a** **Immersion Oil**. Used in high power magnification (Type "A"). 120ml. Medium Viscosity.

**J0326u** **Urine Sediment Stain**. Microscopic examination of urine sediment is a vital part of any urinalysis. This special stain allows visualization of casts and crystals. Similar to Sedi-stain® only 1/3 less expensive. 15ml dropper bottle.

**J0326b** **Lactophenol Cotton Blue**. This stain is useful for fungal exams. It is used in combination with the 10 percent KOH (J-326). First the KOH clears various debris; then the lactophenol cotton blue will stain the fungal elements a deep blue. 120ml.



**J0326s** **Live/Dead Semen Stain**. A necessary component of any male fertility exam is a microscopic evaluation of sperm morphology. The JorVet Live/Dead Semen Stain is a eosin-nigrosin based stain that will stain sperm from every species. 2 x 7.5 ml bottles per package. Complete with detailed instructions and diagrams of abnormal spermatozoa. Keep refrigerated.

**J0326as** **Acid Fast Stain**. A very useful, specialized stain. Use for identification of: Johnes disease, cryptosporidium, acid fast organisms. 126ml bottle.



*NOTE: Uses Loeffler's Methylene Blue as a first stain. Malachite Green is not used due to hazardous shipping requirements.*

This 5-component kit comes with complete directions for use.

**J0814** **Coplin Staining Jar**. The Coplin staining jar is used for holding microscope slides during staining procedures. It is made of polyethylene. Internal grooves hold 6–8 standard slides. 59mm base, 114mm H.



**J-814x** **Coplin jar with black screw cap lid**. Clear thick flint glass with internal ridges for separating slides from each other. Holds up to 50ml.





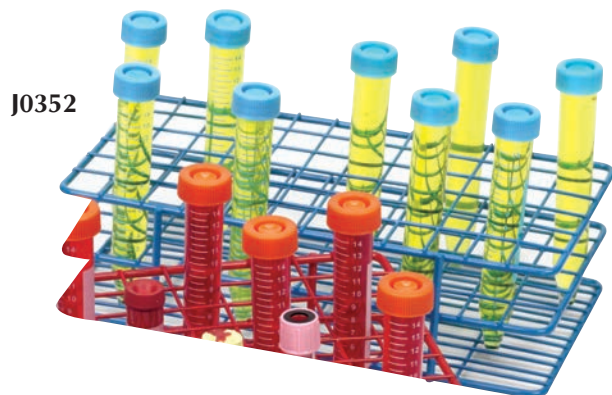

J0352

**J0352 Wire Test Tube Rack.** Tough. Corrosion-resistant. Epoxy-coated. Three-layered deck with square holes. Blue color. Holds 72 tubes in 6 x 12 configuration. 5<sup>1</sup>/<sub>8</sub>"W x 9<sup>1</sup>/<sub>2</sub>"L x 2<sup>5</sup>/<sub>8</sub>"H. Tubes not included.

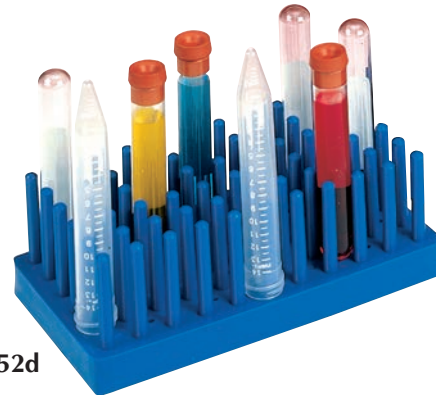

J0352d

**J0352d Full View Test Tube Supports and Dry Rack Combined.** Tubes can be stored upright full or empty or can be inverted over pins for drying. Polypropylene. Steam autoclavable. 50 tube places in 5 x 10 configuration. 66 drying pins. 10cm W x 18cm L x 6.7cm H. White. Tubes not included.

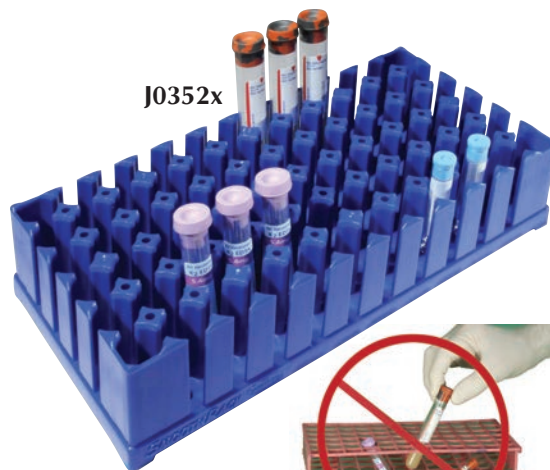

J0352x

**J0352x Smooth Rack.** Two desirable features have been combined to create the Smooth Rack. First, when using a Smooth Rack tubes will never slip into an adjacent position. Second, the Smooth Rack is versatile. It accommodates a wide range of tubes — 10 to 16mm in diameter.

- 72 tube capacity
- 9.7" x 5.0" x 2.6"
- Autoclavable Polypropylene
- Made in USA
- Patent Pending

**J0878 Universal Cube Test Tube Rack.** Put any size tube into this solid tube rack by rotating. Interlock with additional racks. 2 racks/pk. Assorted colors. Tubes not included.

Holds:

- 50ml tubes
- 15ml conical tubes
- 1.5ml micro tubes
- 7.5ml blood tubes



J0878

**Large 50ml Wire Tube Rack.** Epoxy-coated wire rack that holds 50ml tubes. Tubes not included.

**J0879 Single 50ml Tube Rack,** interlocking. 3" x 2<sup>3</sup>/<sub>4</sub>" high.

**J0879a 50ml Tube Rack.** Holds eight 50ml tubes. 5<sup>3</sup>/<sub>4</sub>" x 3" x 3<sup>3</sup>/<sub>4</sub>" high.



J0879a



J0879



**Universal Centrifuge** can be used for both microhematocrit tubes and standard test tubes. The rotors are switched to and fro by adjusting one thumb screw. Rotors hold 24 microhematocrit tubes or 12 standard test tubes 14.5"W x 9.25"H x 17"D. 29 lbs.

- Spins test tubes 0–4,000 rpm
- Safety latch stops motor when cover is open
- Built-in timer and brake
- Spins hematocrits at 12,000 rpm

**J0502m Universal Centrifuge.**

**Combo V24T Digital Universal Centrifuge**

**J0502md Universal Centrifuge with digital time and speed display**

**J0502md5 Micro-tube rotor.** For 1.5ml to 2.5ml tubes. 24 place.

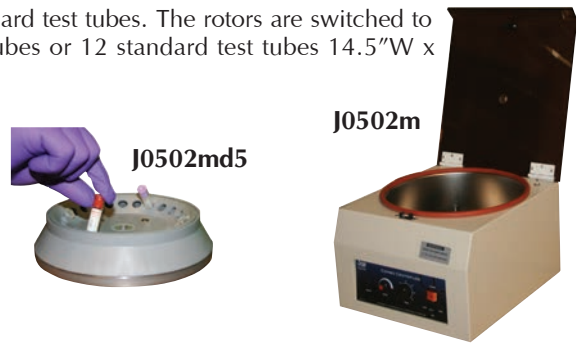

**USA Economy-8 Centrifuge.** The new 2014 Economy-8 fixed-angle centrifuge is now manufactured in the USA and loaded with improvements! This superior centrifuge is manufactured in an ISO-certified, FDA-registered USA facility and sold in the human markets, so expect American quality and support. Choose either variable speed with mechanical timer, or the new digital model.

**Improvements include:**

- **Quieter**
- **Faster** Higher G-forces mean faster serum separations
- **Shorter** Fits under any counter, even with the lid open
- **Cooler** Ventilation system keeps samples cool, preserving their integrity
- **More Accurate** Auto-calibrating feature for exact speeds
- **Braking** Built-in auto-brake stops the rotor in seconds
- **Digital Model** More precision for urine, fecal, or semen samples
- **12v DC Motor** Maintenance-free for years of uninterrupted use
- **CE/CSA** CE/CSA-approved DC power adapter for sale into Canada or Europe

**Standard Features:**

- Includes both large and small tube sleeve inserts to accommodate tubes from 3ml to 15ml
- Angled rotor for spinning blood and urine
- Suction feet for stability
- Variable speed from 500-3500rpm
- Max RCF=1535g
- Auto-switching DC power adapter (110v or 220v input)
- One year warranty on materials and workmanship
- 9.5"H x 11"W x 11"D
- Weight 9.5 lbs



**J0501umV Economy-8 Variable Speed,** with 30-min mech. timer and variable speed control

**J0501umD Economy-8 Digital Speed and digital time**

**USA Ultra Digital Centrifuge.** The new 2014 Ultra Digital centrifuge is manufactured in the USA and is the QUIETEST table-top centrifuge in the veterinary market! At 1,800 rpm's for urine, it is virtually silent. Even at 3,400 rpm's for blood, only a whisper can be heard. This digital centrifuge has options for either an 8-place angled rotor or a 6-place swing-out rotor for spinning fecals with coverslips on the tube.

**Advanced Features include:**

- **Quietest**
- **Digital Controls** More precision for blood, urine, fecal, or semen samples
- **4-speed Memory** Remembers last 4 run cycles, for quick selection
- **ZERO-lock Lid** Lid cannot be opened until rotor is completely stopped
- **Swing-out Option** Lowest-cost swing-out fecal centrifuge available
- **12v DC Motor** Maintenance-free for years of uninterrupted use
- **CE/CSA** CE/CSA-approved DC power adapter for sale into Canada or Europe

**Standard Features:**

- Includes both large and small tube sleeve inserts to accommodate tubes from 3ml to 15ml
- Perfect for blood and urines, plus fecals
- Suction feet for stability
- Variable speed from 500-3400rpm
- Max RCF=1450g
- Auto-switching DC power adapter (110v or 220v input)
- One year warranty on materials and workmanship
- 10.5"H x 14.5"W x 14.5"D
- Weight 11.6 lbs

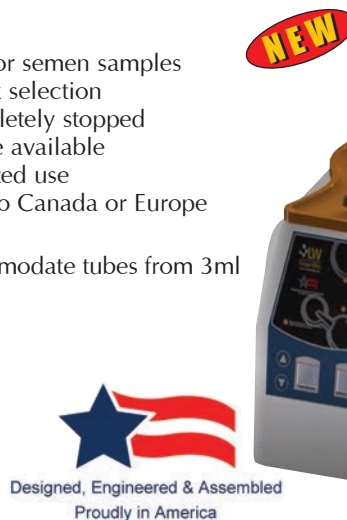

**J0501wc**

**J0501wc USA Ultra Digital Centrifuge,** 8-place angled rotor

**J0501wch USA Ultra Digital Centrifuge,** 6-place horizontal swing-out rotor (metal rotor and sleeves – autoclavable)

**J0503m Microhematocrit Centrifuge.** This durable centrifuge provides fast results.

**Features:**

- Tube cover and reader disc to read tubes while still on rotor
- Auto off 15 minute timer (on/off switch with indicator light)
- Safety shut-off switch in impact resistant plastic window for safe viewing
- 24 tube (75mm capillary ea.) capacity
- Metal body construction
- Suction cup feet to prevent slipping
- 110V power
- 10.6"W x 8.7"H x 12.5"D; 15.8 lbs.



**Horizontal Swing-out Centrifuge.** The **J0501sq** centrifuge is designed, engineered, and assembled here in the USA. Horizontal centrifuges will recover significantly higher numbers of parasite ova than fixed-angle centrifuges or standing fecal floatation procedures. The **J0501sq** centrifuge tubes hang vertically while at rest, allowing for the test tubes to be filled completely with a coverslip placed on top of the tube. The tubes then accelerate slowly and swing to a horizontal position while spinning. After completion, simply remove the coverslip and place directly onto a microscope slide. The **J0501sq** also performs routine urine and semen separations, high-speed blood separations in minutes, and can run microhematocrit samples with the included Crit-Carriers (patent pending). New adjustable-friction hinges allow the lid to be held at any angle, which means it will fit on nearly all countertops with low cabinets above.

**Features:**

- Touch-pad time and speed controls.
- 4-character digital display screen.
- 60 minute programmable timer.
- 800–5,000 rpm programmable speed, up to 4,200 g-force.
- Rubber feet to prevent slipping.
- Zero-RPM interlocking Metal lid with view port.
- Heavy-duty, quiet, brushless DC motor – maintenance free.
- One year warranty on materials and workmanship.
- Dimensions: 15.5"W (393mm) x 18"L (457mm) x 12.7"H (320mm).
- Weight: 39 lbs (17.7kg).
- Includes Crit carriers (**J0501rc**) for microhematocrit tubes (see below).
- Metal rotor and tube sleeves are autoclavable for PRP/Stem Cells



**J0501sq Horizontal Swing-out Centrifuge** – 8-place 3ml-15ml rotor (metal – autoclavable)

**J0501st Horizontal Swing-out Centrifuge** – 4-place 50ml rotor (metal – autoclavable)

**IRAP Centrifuges.** JorVet offers centrifuges that can easily ‘spin down’ the IRAP syringe contents:

- digital controls
- silent or quiet operation
- simple to use with safety features

**J0501sqr Centrifuge** with 4-place IRAP rotor only.

**J0501sqi Centrifuge** with 4-place IRAP rotor and additional rotor for 15ml tubes.

**J0501sqic Centrifuge** with 4-place IRAP rotor and additional rotor 15 ml tubes and CRIT carrier for microhematocrit tubes.

**Crit Carrier.** The Crit Carrier (patent pending) is specifically designed to run hematocrits on your Horizontal Centrifuge (minimum 5,000 rpms). Simply insert your hematocrit capillary tubes into the carrier, place the carriers in opposing tube sleeves for a balanced load, and spin at 5,000 rpms for 8 minutes for a clear separation. The Crit Carrier converts the **J0501sq** centrifuge into a Hematocrit Centrifuge. Save counter space and the need to purchase an additional hematocrit centrifuge. Spins up to 8 standard 75mm capillary tubes.

Crit-Carriers only work with high-speed horizontal centrifuges, like the J-501sq and the original Straight 8-5k.

**J0501c Crit Carrier.**

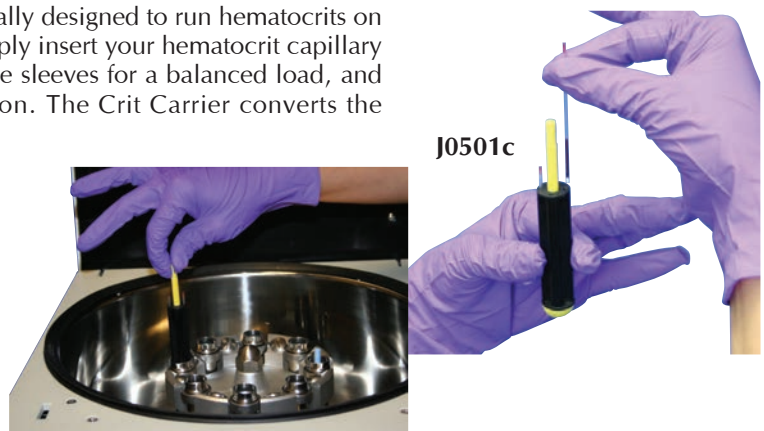

The IRAP procedure requires centrifuges that:

- will have at least 5,000 rpm
- a rotor that will take the large 60ml IRAP syringe

**J0501ir IRAP Rotor only.** For use with **J0501sq** or **J0501s**.



**J0501ir**  
IRAP  
Rotor

**J0501sx Centrifuge with 4x 50ml swing out buckets.** This is the rotor for use with Arthrex brand double-syringe tubes or 50ml tubes for spinning semen. Note: all rotors can be purchased separately. Check pricelist.



**J0501sxd1**

**J0501sxd1 Bucket Rotor.** Four-place Bucket Rotor with 50ml/Arthrex ACP inserts. (additional inserts to hold 24 test tubes are available.)



Rotor for Dechra's  
Osteokine Centrifuge

*The rotor for Dechra's Osteokine PRP system will work with the J0501sq Centrifuge. The rotor needs to be purchased via Dechra.*

The IRAP procedure is quickly gaining popularity in the equine field. The procedure requires some special centrifuges and ancillary items that are readily available from JorVet. This page shows some of those additional equipment sources.

**J0464m Female luer lock syringe cap blue.** Luer lock cap used to cap 6ml syringe after transfer of serum.

**J0464m**

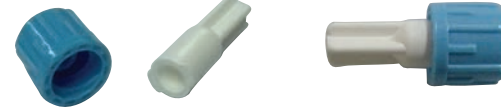

**J0463a Female-female luer lock connector.** Female to female luer lock connects 6ml syringe to 33mm filter.

**J1081 Filter 0.2 micron male/female luer.** Filter is used when transferring serum to 6ml syringes. Procedures will require multi filters. Syringe not included.

**J1081k IRAP Ancillary Kit.** Enough ancillary for one IRAP procedure. Contains **J0464m** (4), **J0463a** (2), **J1081** (2), **J0174bhx** (1), **J0480b** (1). Syringe not included.



**J1081**

**J0174bhx Stainless Steel hypodermic needle.** 18g x 4". Sterile.



**J0174bhx**

**J0501bt Test Tube Balance Rack.** Important to have a balance tube for proper use of a centrifuge. This acrylic rack will hold up to 6 different size tubes so they are always readily at hand.



**J0501bt**

This handy rack attaches to the side of a centrifuge via double sided tape.



**J0501bt**  
in use



**USA Portafuge.** The new 2014 Portafuge is manufactured in the USA. The Portafuge is an economical centrifuge designed for spinning on the go and has now been upgraded to include fixed-speed, variable-speed, and digital models. Now any fluid can be spun in the field, even low speed separations like urine, semen, and fecals. Every Portafuge includes both the cigarette plug and also the car seat for safe transport. Simply insert the cigarette plug into your car's power outlet and buckle it up for quick blood separations at up to 3500rpm.

**Advantages:**

- Portable, 12v unit, works in any car
- Lightweight
- Quiet, vibration-free operation
- Space-saving design

**Features:**

- Angled 8-place rotor
- 8-tube capacity – 3ml to 15ml size tubes
- Up to 3500 rpm speeds
- 12v DC motor – maintenance free
- Suction-cupped feet prevents slipping
- Lid Safety Switch
- 80-watt power requirement
- Maximum RCF = 1535 g

**Includes:**

- Eight-place tube rotor
- Eight 15ml tube sleeves
- Eight 13x75mm tube sleeve inserts
- Car Seat
- Car power outlet plug

Warranty: One year on materials and workmanship

Dimensions: 9.5"H x 11"W x 11"D

Weight: 9.5lbs

- J0501pf** Portafuge, fixed-speed with timer, car seat, car cord
- J0501pv** Portafuge, variable-speed with timer, car seat, car cord
- J0501pd** Portafuge, digital, car seat, car cord
- J0501p1** AC power adapter cord for Portafuge



**J0501pf**  
Special car seat  
for centrifuge

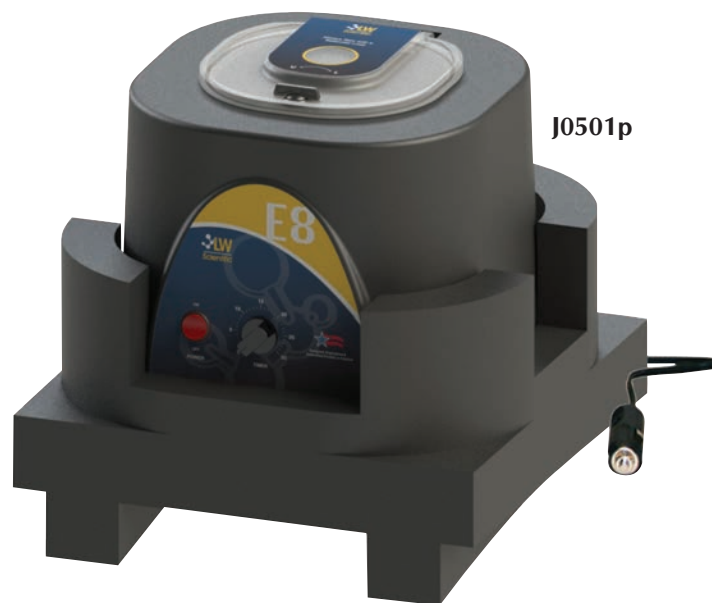

**J0501p**



**J0501p1**

**Anti-Vibration Mats.** A special 3M material that is designed to quiet noisy centrifuges or other vibrating instruments. The mat is chemical resistant, easy to clean, and will fit easily under most centrifuge models. The mat is blue.

- J0504y**     **Anti-Vibration Mat.** 15" x 18"
- J0504x**     **Anti-Vibration Mat.** 14" x 14"



J0504y/x

**Sheather's Sugar Flotation Solution.** *Find more eggs!!* Recent studies have proven that centrifugation of fecal samples is more effective than traditional standing passive flotation. Furthermore, a flotation media must have a higher specific gravity than 1.20 to float many of the common parasite ova.

Sheather's sugar solution has a specific gravity of 1.27 which is high enough to float any ova. *Basic Physics: If an ova has a higher specific gravity than the flotation solution, it will not float nor will it be detected.* . .

- J1028**     **500ml bottle**
- J1028g**   **Gallon size bottle**

**J0952**     **Contrate Fecal Filters.** Contrate fecal filters are especially useful when used in conjunction with swing arm centrifuges for fecal exams. The filter is designed to seat on top of conical test tubes. It is used to filter out particulates and debris from fecal solution after the flotation solution has been mixed with the sample. The contrate fecal filter helps eliminate messy spills and is a good substitute for gauze sponges or tea bag strainers. 5/pkg. Tray not included.



J0952

**J0501h**     **Hydrometer for fecal flotation solutions.** This hydrometer is perfect for testing fecal flotation solutions in the narrow specific gravity range of 1.18 to 1.25. The best results for detection of parasitic ova are using solutions in the S.G. range. This hydrometer is the best and easiest way to confirm you are using the right solution. 6" long glass – suggest clear round graduated cylinder (**J0281d2**) for holding and floating hydrometer.

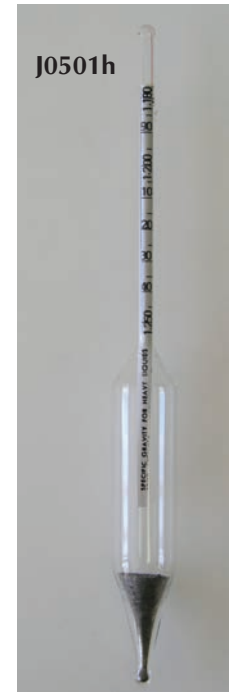

J0501h

**J0813m**     **Incubator.** A compact, inexpensive, and reliable incubator that is perfect for incubating cultures. Do a better job of diagnosis and treatment of bacteriological cases in your clinic with the use of this incubator.

- tinted acrylic door
- Capacity 0.7 cubic feet
- Chamber is 10"h x 12"w x 10"d
- External size is 15"h x 13"w x 10.75"d
- Weight 23 lbs.
- UL listed
- 18-month limited warranty



J0813m

**ZipSpin Centrifuge.** New for 2014, the ZipSpin is now DIGITAL and loaded with new features! This portable, compact microcentrifuge is microprocessor controlled — for precision, safety, and ease of use. More and more tests are done with smaller sample sizes, so this is a must-have for any veterinary clinic. The new ZipSpin rivals the features of the popular “STAT” centrifuges at one third the price.

- Spins blood and urine samples
- Digital speed and time display
- Quiet operation and maintenance-free motor
- Imbalance detection shut-down feature
- User calibration feature
- Electronic brake for quick spin/quick stop
- 8-place rotor for 1.5 and 2ml microtubes
- Adapters for 0.2ml and 0.5ml microtubes
- PCR strip rotor included
- Variable speed: 0 – 6,000 rpm
- RCF up to 2,000g
- Small footprint to conserve space
- Lid safety switch
- 110v/220v AC power input

Dimensions: 4.5”H x 6”W x 6.5”D Weight: 2.5lbs.

**J0501zd ZipSpin Centrifuge**

**NEW**

**J0501zd**



**J0548**



**Test Tube Rocker.** Its gentle back and forth motion is designed to protect blood samples from clotting before they can be evaluated. Smooth mixing action for consistent uniform specimen suspension. Ideal for blood collection tubes. 24-month warranty.

**J0819 Large Blood Rocker.** Holds 16 tubes. Dimensions 13 1/2”L x 4”H x 5 1/4”W. Weight 4.8 lbs.



**J0819**

The **Digital Differential Counter** uses modern technology for simple and accurate blood cell counts. A short beep sounds with each touch on the touch pad to confirm the count, and a long beep indicates you have reached 100 cells. 8 buttons are labeled with cell names and cell pictures for Baso, Eosin, Myelo, Juven, Stab, Seg, Lymph, and Mono, plus there are two more blank buttons for additional cells. Push the percent button at any time to automatically calculate percentages.

**J0505c Digital Differential Counter.** 10 keys – 110v AC Dimensions 8.6” x 6.3” x 3” Weight 1.3lbs



**J0505c**

**J0505 Hand Held Tally Counter.** Used for counting blood cells, bacteria colonies, drops of liquid or any repetitive event. Tallies up to 9,999.

Features a quick reset button and a finger ring for a secure grip. Sturdy, chrome-finish metal construction.

**J0505**





**Differential Cell Counter** allows the percentage of each type of white blood cells to be counted (leukocytes). Every stroke makes a distinct sound, and when a total of 100 is reached a bell will ring.

**J0505a 5 Unit Cell Counter.** Basophils/Eosinophils/Segmented Neutrophils/Lymphocytes/Monocytes. 24.5cm x 7.5cm x 5cm.

**J0505b 8 Unit Cell Counter.** Basophils/Eosinophils/Myelocytes/Juveniles/Band (Stab)/Segmented Neutrophils/Lymphocytes/Monocytes. 30cm x 7.5cm x 5cm.



**Revelation III Microscope** is the ORIGINAL, best-selling, most durable and dependable microscope in the veterinary field. The LED illumination offers bright daylight color, with no heat, low power consumption, and super long life. Excellent for the veterinary in-clinic laboratory, whether doing fecal floatation on 10x to cytology on 100x oil immersion.

- Mechanical stage with coaxial controls (140mm x 140mm)
- Binocular head with wide field 10x eyepieces
- Four DIN achromatic objectives: 4x, 10x, 40x, and 100x.
- Moveable ABBE condenser N.A. 125
- 50,000 hour LED bulb – daylight color, no heat
- Fine and coarse focus adjustments
- Dust cover
- Inexpensive

**J0334ab Revelation III LED Microscope,** complete.

**J0334taL Revelation III Lab Microscope LED Trinocular Microscope,** complete.

**J0334at Trinocular Head,** optional.

**J0334acs Soft Carrying Case** for Revelation III Lab Microscope.

**J0334ac Hard Carrying Case** for Revelation III Lab Microscope. (not pictured)



*NOTE: For information on camera link to microscope turn to page 293.*

**Infinity Labscope.** This new model has a beautiful design with a number of important features.

- Infinity optics usually found only on very expensive microscopes. Best optical system for highest clarity and resolution.
- LED illumination: gives bright almost daylight illumination with very long-lasting bulb, with cool temperature
- 4 semiplan objectives, flat field across 95% of your view
- 10x/20 super-wide eyepieces to see more of the specimen at each magnification power.
- Ergonomic design – can rest your arms and hands flat on the table with all controls in easy reach.
- Optional 50x oil infinity objective – the highest resolution objective available, which doubles the view of the 100x oil for faster scanning and counting.

**J0334q Infinity Labscope**

**J0334qt Infinity Labscope** with trinocular head. Preferred microscope for use with OmniVid camera.

**J0334qc Infinity Labscope Hard Carrying Case.**



**Microscope Accessories.** Reticles: A measuring grid installed at the end of a special eyepiece can give the user important measurements. For example, this can help identify parasite ova by actually measuring their microscopic size. Please specify your eyepiece mm size with manufacturer and model number.

- J0334ad2** Reticle for Rev III microscope or Infinity LabScope
- J0334mep** Eyepiece with pointer (J0334mp series)
- J0334mpd4** Reticle for J0334mp series

- J0334ac** Hard Carry Case for J0334a microscope.
- J0334qc** Hard Carry Case for J0334q microscope.
- J0334mc** Hard Carry Case for J0334mp microscope.
- J0334mic** Hard Carry Case for J0334mi5 microscope.
- J0334xc** Hard Carry Case for J0334x microscope.

**Mi-5 Laboratory Microscope.** Jorgensen Laboratories is proud to introduce the new Mi5 microscope, our most advanced modular microscope to date competing with Nikon, Olympus, and Zeiss. The Mi5 was developed for use in a broad range of applications from routine research and lab inspections, to more specific health-care applications such as pathology, cytology, oncology, hematology, and reproduction. Bright white LED illumination provides daylight illumination, super-long bulb life, low power consumption, and no heat. Superior infinity optics produce the highest resolution images, and the 5 PLAN objectives offer flat focus across 100% of the field of view. The included 20x objective allows for faster scanning of cytology slides. The narrow base, ergonomic design, large eyepieces, and soft eyeguards make the Mi5 comfortable to use for extended periods of time. The Mi5 is equipped to ease the burden on the busiest and most discriminating lab technicians and doctors.

- J0334mi5** Mi-5 Infinity Lab Microscope, Binoc, PLAN, 5 objectives, LED
- J0334mi5t** Mi-5 Infinity Lab Microscope, Trinoc, PLAN, 5 objectives, LED. Works great with MiniVID USB or OmniVID cameras for educating clients and technicians, and documenting medical records.
- J0334mpd2a** 50x Infinity Oil-immersion Infinity PLAN objective for Mi-5 (also works on other infinity microscopes).
- J0334miDH** Mi-5 Infinity Lab Microscope, DUAL Binocular, PLAN, 5 objectives, LED. High-level teaching laboratory microscope, perfect for vet schools and teaching laboratories and dermatologic applications.
- J0334mi5TDH** Mi-5 Infinity Lab Microscope, DUAL Head with Trinoc-Binoc with camera C-mount, allows two people to look into the microscope while a group of students view images on the monitor. (Recommended camera: BioVID HD/SD)

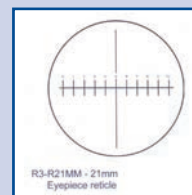

J0334 series



J0334qc



J0334mi5



J0334miDH

**J0334dc Nylon Dust Cover for Microscopes.** Economical method to keep dust and other debris off microscope lenses, etc. while your scope is not in use. Soft nylon material. Navy Blue. Width 19.5" x 20" high. Fits most microscopes.



J0334dc

**J1133 Droplet™ Blood Collection Tray.** This handy Tray allows easy access and storage of every thing necessary for blood collection

- Sturdy lightweight ABS plastic frame measures 429mm (17") x 265mm (10.6") x 172mm (6.9")
- Side supply drawer
- 4 side pockets on both ends
- Soft rubber grip on handle that ratchets out of the way
- Included 36 place test tube rack
- Remove tray for easy cleaning
- Extra deep compartment for sharps container
- Tray with 1 extra insert and a 36-place 16mm test tub rack



J1133

**J1182a Hot Water Bath.** The JorVet Water Bath creates a constant temperature with an open reservoir and immersion circulator, ideal for heating temperature-sensitive samples. The stainless steel reservoir is seamless, eliminating the possibility of rust and leaks, and the rounded corners are easy to clean. The control unit achieves the desired temperature quickly and maintains a constant temperature to prevent sample overheating. Select desired setting with the touch-pad digital controller, and view the actual temperature on the red LED display. The compact design and stainless steel reservoir make this product a must for every job.

Tank:10 liters capacity

- Temperature range: Ambient +5° to 100°C
- Weight: 21.2lbs (9.6kg)
- DIMS: Height 7.5"(190mm) Width:21.2" (540mm) Depth:13.4" (340mm)
- Internal Tank DIMS: Height: 5.9" (150mm) Width: 19.3" (490mm) Depth: 11.4" (290mm)
- 110V AC power supply (220v available)



J1182a

**Also available:**

**J1182 Oscillating Water Bath.** Built-in variable-speed shaker keeps stem cells or other cells suspended. Call for details.

The Labscope provides everything needed to perform motility analysis and to observe morphological abnormalities to determine viability of sperm. Sperm concentration can be performed with the Neubauer Hemacytometer used to create a 0.1mm x 0.1mm x 0.1mm cubic counting chamber.

**J0821 Neubauer Hemacytometer.** Designed especially for counting blood cells. Double rulings are visible through a wide range of illumination. Neubauer rulings are 0.1mm below cover glass. The "H"-shaped moat offers two counting areas. Fused rhodium on glass provides distinct lines. Can be used with our **J1195a** and **J1195** Leukotic Plus products.

**J0821c Extra Cover Glass.**



J0821

**J0821X Cell-VU Hemacytometer System.** The safety hemacytometer system for use with all manual-counting procedures.

- Sperm
  - WBC
  - CSF
  - Urine
  - Consists of both the slide and cover slips
  - Slide is dual chambered providing for two determinations per sample
  - Cover slips are laser-etched grid that is easy to view
- Each system consists of: 3 slides with dual chamber and 6 cover slips with etched grid  
Directions for sperm concentration included

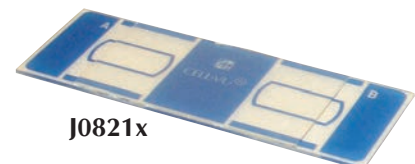

J0821x



A JorVet exclusive, **Semen Evaluation LabScope**, is perfect for veterinarians interested in live specimen microscopy including: semen evaluation, live biological specimen analysis, and standard brightfield applications. Motility analysis should be performed at 37°C to keep sperm active. The heated stage has a digital temperature control unit permitting temperature settings between 25–50°C and maintains accurate and stable temperatures within +/-0.5° during observation. Unplug the cord from the stage, and the LabScope looks and functions like a standard laboratory-grade microscope. The PLAN phase objectives and turret condenser allow flat-field, high contrast viewing of live, unstained specimens, and easy magnification changes with the flip of the thumb. Simply turn the turret condenser wheel to switch between brightfield, phase 10x, phase 20x, phase 40x, and phase 100x settings.

System Features:

- Laboratory binocular microscope
- 10x/20 high-point, oversized WF eyepieces
- Complete semen evaluation system
- X-Y mechanical stage for precise slide movements
- Built-in heated stage with removable cord
- Variable digital temperature control 25–50°C
- Set temperature in 1° increments
- Displays actual temperature in 0.1° increments
- Accurate within 0.5°C
- Reaches temperature with 1–2 minutes
- Switchable power input 110V or 220V AC
- Digital temperature control unit
- 84mm (3.4")W x 225mm (9")L x 153mm (6.5")H
- 2.5 kg (5.5 lbs.)
- Turret condenser with phase contrast and brightfield
- PLAN flat-field phase contrast – Phase 10x, Phase 20x, phase 40x, phase 100x
- DIN PLAN flat field objectives
- Variable LED Koehler illumination
- Includes blue-green-yellow filters, immersion oil, dust cover & manual
- Microscope specifications
- 200mm (7<sup>7</sup>/<sub>8</sub>")W x 270mm (10<sup>5</sup>/<sub>8</sub>")L x 420mm (16<sup>1</sup>/<sub>2</sub>")H
- 9kg (20 lbs.)
- 110V or 220V AC power
- Lifetime warranty on mechanical and optical components, 1-year warranty on electrical components

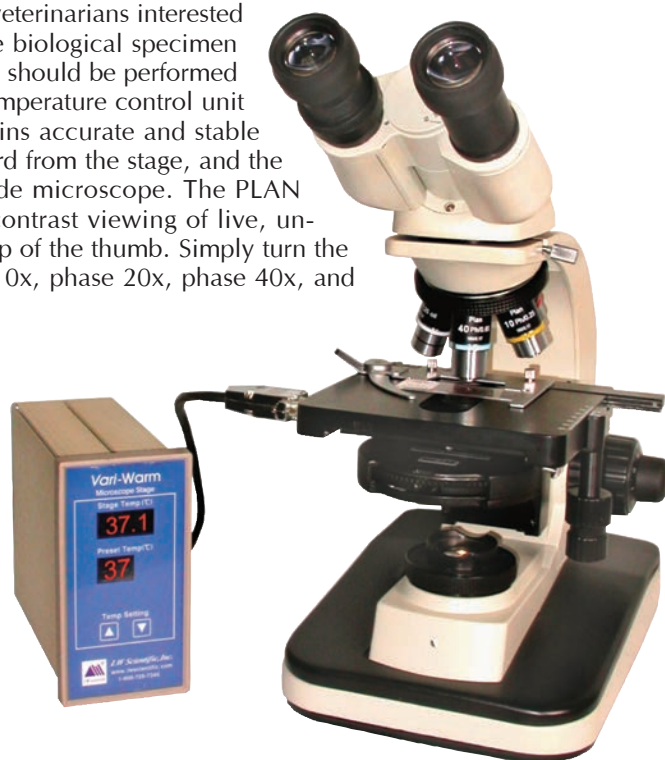

**J0334x Semen Evaluation Binocular LabScope.**

**J0334xt Semen Evaluation Trinocular LabScope** with Camera Connections (optional)

**OmniVID C-Mount Camera.** The Omnivid is the first “All-in-One” comprehensive microscope camera on the market. It features built-in live video on a bright 2-inch LCD screen. 8 megapixel digital imaging, and MPEG4 video directly onto the included SD memory card. Connect to any size TV for training large groups, or connect to a PC for capturing digital images or digital video in the easy-to-use MicroCap V2.0 measuring software. Use the wired remote control to snap pictures or access the menu and playback modes. The Omni mounts directly onto any microscope trinocular head with C-Mount threading. The Omni camera on a JorVet microscope is the ultimate microscopic imaging solution.

Works great with JorVet Infinity labscope (**J0334qt**)

- Sensor resolution: 3.1 Mega Pixel
- Maximum resolution: 8 Mega Pixel
- LCD screen size: 2 inch LTPS
- Memory card: SD/MMC card
- USB interface: Yes
- TV output: NTSC/PAL
- Controller: Remote and USB shutter
- Power Supply: CD 12V 1.5A
- Picture Format: JPEG
- Video Format: MPEG4
- Printer support: PictBridge and DPOF
- Mount: C-Mount

**J0475cv OmniVID C-Mount Camera.**



J0475cv



**Mini-Vid RCA Live-Video Microscope Eyepiece Camera.** This is the ideal camera for watching your microscope slides LIVE on TV. The small camera slips into your microscope's eyepiece and hooks directly to any TV. Focus through remaining eyepiece. Fits all brands of microscopes, and the RCA cable connects to most TV's or VCR's.

- 400 line resolution
- Very affordable
- 110V adaptor to 12V
- 6' RCA video cable
- 3 oz.

**J0822rca Mini-Vid RCA Video Eyepiece Camera.**

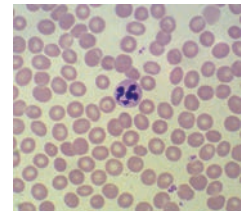

**MiniVID USB Digital Camera.** The MiniVID is our best-selling camera for microscopy, which includes software for capturing high-resolution 5.1mp digital images and digital video clips. Now choose from 3 models: USB2.0, USB3.0, or WiFi! Works on nearly any brand of binocular microscope through the eyetube, or on any trinocular microscope via C-mount threading!

- Includes PC / windows and MAC compatible software
- Captures images for training, or emailing, or documenting in client records
- Client education: allows comparison of normal versus abnormal cases (i.e. semen evaluation)
- Camera will also thread onto trinocular C-mount
- Measuring tools

**J0822qm5 MiniVID 5.1mp USB2.0 Digital Eyepiece & C-mount Camera** – Best-selling, lowest-priced model for any computer

**J0822qm5u3 MiniVID 5.1mp USB3.0 Digital Eyepiece & C-mount Camera** – Very fast frame rate (must have newer computer with USB3.0 “blue” port)

**J0822qm5wf MiniVID 5.1mp WiFi Digital Eyepiece & C-mount Camera** – With Windows-Android-IOS software for use wirelessly on PC, Android tablets and phones, iPhone, and iPad. Allows the whole classroom or clinic to view images live on their devices!



**J0822qm5 on Trinocular**



**BioVID HD/SD Camera.** The BioVID HD/SD microscope camera is now High Def and includes SD-card image capture! Connect to any trinocular microscope via C-mount threading, and plug the HDMI cable into any large screen HDTV for amazing resolution and fast-action video (30fps)! The BioVid-HD/SD has true 1280 x 720 resolution, increased sensitivity, low-noise, and great color rendition – creating stunning, high resolution images with smooth live-image display. Whether in a large lecture hall, a classroom, or the clinic, the BioVID-HD/SD will ensure clients and students see microscope images clearly. Reach up and press the SAVE button to capture 5mp still images onto the included SD card. This camera works great for all routine bright field work, and even in darker applications such as dark field, phase contrast, and Epi-Fluorescence.

**J0822hdsd BioVID Camera, HDMI cable, SD card**



**J0822hdsd Front**



**J0822hdsd Back**

**J0755 Inspector Zoom Embryo Transfer Stereoscope.**

A high resolution stereo zoom microscope, also called a dissecting microscope, with both lower (transmitted) and variable upper (reflected) illumination. Its clean 3D imaging and broad field of view make it perfect for selecting viable embryos. Use the lower transmitted, dim the upper light, and zoom the magnification from 6.5x to 45x to see the structure and condition of each embryo. High magnification options up to 72x or 90x are available. Frosted glass stage with two holding clips.



J0755

**J0755t Inspector Zoom Trinocular microscope complete**

▲ Excellent Top and Bottom Illumination

**Microscope Cleaning and Service Kit** will work for any and all microscopes. The microscope is a workhorse in the veterinary clinic. It is routinely exposed to many solutions between laboratory stains, immersion oils, and body fluids. These all can adversely affect the optical performance. Routine cleaning, adjustment, and alignment are a necessary function to get the best diagnostic quality images from your microscope. This job is difficult without the proper tools and instructions.

The JorVet microscope cleaning and service kit makes this possible for even the novice microscope user. The kit contains ten different components in a storage case.

**J0869k Microscope Cleaning and Service Kit.** Contains:

- **J0869 Lint-Free Lens Tissues.** Special grade pop-up sheets remove oil immersion that collects and dries on objectives. 3" x 4 1/2" x 4 1/2". 280/box. Similar to Kim Wipes.
- **J0869s "No-Residue" Lens Cleaning Solution,** 1 oz. dispensing bottle. Removes dried residue from objectives. Use with **J0869** lens tissues.
- Micro-fiber lens cloth that removes dust and debris from the scope (9" x 9")
- Soft-bristled dusting brush for routine removal of dust and debris
- Set of 3 Allen Wrenches: 1.5mm, 2.0mm, 2.5mm
- Micro-glide gear lubricant
- Precision screwdriver set (6) for very small microscope screws
- Air duster 8 oz. pressurized aerosol can with exterior tube
- Cotton tip applicators (100) for cleaning objectives
- Friction collar small double-sided wrench
- Black nylon zippered storage case. 4" x 7" x 10". 1.9 lbs.
- Detailed illustrated service manual, and a glossary of common microscope terminology



J0869k

**J0869x Microscope Accessories Custom Organizer.** A wide variety of items accumulate around a microscope station: slides, pipettes, lens paper, cleaning solutions, immersion oil, and cover slips, etc. These all can be organized in an attractive, clear acrylic display of divider boxes. Each divider box has double-sided foam tape for custom attachment to the central station. 11"W x 14"L x 11"H.



J0869x



**J0351 Clinical Refractometer.** A high-quality clinical hand-held refractometer for quick and accurate urine specific gravity plus serum total protein measurements. Adjustable focus. Temperature compensated. Comes with protective case. 7"L.

**BRIX Refractometer.** Measuring the quality of equine and bovine colostrum just got easier. BRIX refractometers traditionally measure sugar content in juices and fluids. The new BRIX refractometer is compact, durable, and easy to use, and it only takes a few drips to test quality in colostrum. BRIX scores of 22% or higher represent good quality in colostrum, 1-21% represent colostrum that can be used for second feedings, and scores below 1% will need to be supplemented.

TOTAL SOLIDS in milk can also be determined using the BRIX refractometer. 12.5% to 13% total solids would be expected in normal milk. The following equation was developed to convert to total solids in milk:  $TOTAL\ SOLIDS = (0.994 \times BRIX\ reading) + 2.077$ . Therefore, a BRIX reading of 10.4 equals 12.5% total solids, and a reading of 10.9 equals 13%

**J0351b BRIX 0-32% Optical Refractometer,** automatic temp compensating, focusing eyepiece, carry case, easy-to-read scale.



J0351  
J0351b

**Checker pH Meter.** Small animal veterinarians spend a great deal of time discussing special dietary management and urinary acidifiers for controlling urinary tract disease. The maintaining of urine pH between 6.0 and 6.8 is necessary to minimize struvite crystal formation; usually paper reagent strips are used to determine urine pH through very subtle color changes. Using a pH meter is much more accurate than simple urine reagent strips.

Features:

- Economical, costs less than a bottle of reagent strips
- Fast, easy and highly accurate calibration: 0.2 pH at 68°
- High resolution: reads down to 0.01 pH units
- Small sample required, will fit into small container
- Small lightweight design: 2 1/2 oz with 6" electrode
- Battery operated with 3000 hour life

**J0753k Checker pH Meter Kit.** Includes pH meter, screw-on electrode, buffer kit and storage solution.

**J0753 Checker pH Meter.**

**J0753d1 pH Replacement Electrode.**

**J0753d2 Buffer Solution, pH 4.** 230ml.

**J0753d3 Buffer Solution, pH 7.** 230ml.

**J0753d4 Buffer Kit.** 5 packages of each solution.

**J0753d5 Electrode Storage Solution.** 230ml.



J0753



J0892

*NOTE: All pH meters need to be calibrated, and should be stored in the J0753d5 solution.*

**pH Indicator Paper.** Knowledge of body solution or fluid pH (i.e., urine, ruminal contents and abdominal tap) is required frequently in veterinary medicine.

pH papers provide a fast, simple, and economical method of pH measurements. For most solutions, it is only necessary to dip a short strip of test paper in the solution for a second or two. Then, shake off the excess fluid, match the color of the wet test paper with its color chart, and read off the value.

**J0892 pH Paper Roll in Plastic Dispenser.** Test strips on a continuous roll, tear off what you need. pH range 4-9. 15'.

**J0893 pH Paper Individual Strips in a Box.** pH range 5-9, colors for each 0.5 pH unit. 100 strips.



J0893



**Urine Reagent Test Strips** are the “dip and read” test that is an integral part of every urinalysis. The JorVet test strips match colors that most familiar to veterinarians and technicians. Color-coding located on side panel. Economically priced, up to 50 percent savings over competitor brands. 100/canister.

- Easy-to-use
- Clinically tested for accuracy
- Up to 2-year shelf life before opening
- **Strips must be used within 90 days of opening bottle**



J0630x

**J0630x Vet-10 Urine Reagent Test Strip.** These urine test strips offer two major advantages:

- Veterinary specific: for urine specific gravity these strips allow values for what veterinary medicine requires
- Priced at considerable savings over other brands

These test strips are a high quality grade product made in the USA. The 10 colors on the strip are configured in the same order as the Ames Multistix-10® to avoid confusion and maintain continuity.

The expanded test strip now has the 10th test for leukocytes. 100 test strips per bottle. The strips test for:

1. Nitrite
2. Urobilinogen
3. Protein
4. pH
5. Specific Gravity
6. Ketone
7. Bilirubin
8. Glucose
9. Blood
10. Leukocytes



J0630y

**J0630y Vet-BUN Blood Reagent Test Strip.** These sensitive color-coded test strips use one drop of whole blood to give blood urea nitrogen (BUN) reading. They are a quick and simple screening test for this important blood parameter. Made in the USA. 25 strips per bottle. **Must be used in 60 days.**

**J0630g Glucose-Only Test Strip.** Suggested for monitoring diabetic cases. 100 tests.

**J0630k Ketone-Only Test Strip.** Screening for ketosis in cattle and sheep. 100 tests.

**J1046 Portable Bunsen Burner.** A standard Bunsen burner is not a practical item for most clinics. However, this small portable burner will provide rapid and concise flame heat where needed in the clinic.

- culture or micro work
- heat fixes slides i.e. gram stain
- sterilizes instrument

This portable completely self-contained compact burner features instant ignition for a fast and reliable startup every time. Simply rest your hand on the touch sensitive pad to instantly ignite the burner. Lift your hand from the pad when you're done to extinguish the flame and shut the unit off. The touch activated burner also features a handy dual use locking mechanism that will either lock the flame on, for those longer jobs, or function as a safety lock that prevents accidental ignition. Weighing just 11.2oz. 1 year warranty. Touch Activated Ignition Pad

- Self Contained & Butane Refillable
- Flame Adjustable Dial -
- Butane Blue or Yellow Flame
- Safety Lock Prevents Ignition
- Lightweight and Portable - Moves easily between workspaces
- Includes 1 AA Battery
- Approx 65 mins burn time -
- will vary according to flame length



**J0549c Inoculating Loop with Handle.** Inoculating loops are a necessary part of doing any sort of bacterial culturing. These Nichrome wire loops are attached to an anodized aluminum handle. The wire loops are durable plus rapidly cool following heat or flame sterilization. The loop is a 3mm diameter or 26g wire. Each.

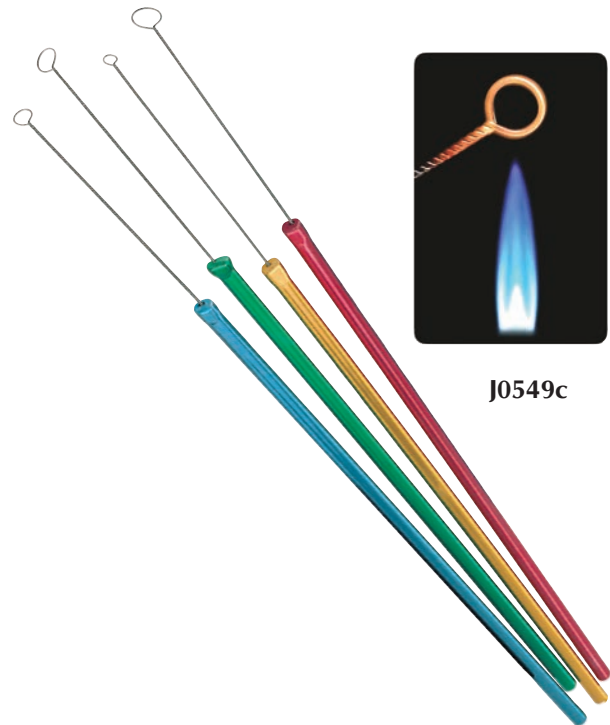

J0549c

**J0549A Inoculation loops.** Double-ended inoculation loop. One end has a 10ul size loop the other end a smaller 1ul loop, disposable individually wrapped and sterile. 50/pk Polystyrene



J0549a



**Microscope Slide.** High-quality glass slide that will serve every clinical lab need from permanent mounts to fecal samples.

- Slides individually separated by thin tissue paper to prevent sticking together.
- Smooth edges with beveled corners
- 1" x 3" x 1.2mm (1/25") thick

**J0335** Slide. Clear. 72/box.  
**J0335f** Slide. Frosted. 72/box.

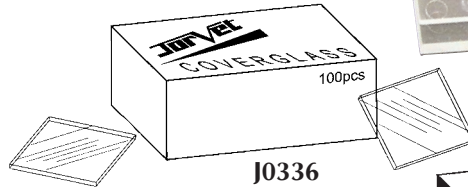

J0336

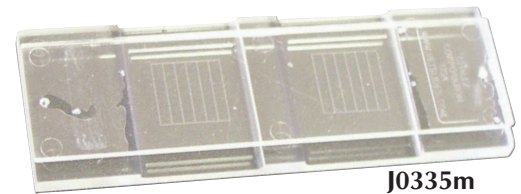

J0335m

**J0335m** **McMaster Egg Counting Chamber.** Special microscope slide with two etched chambers for quantitative fecal analysis.

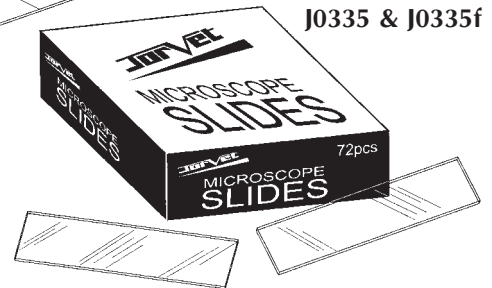

J0335 & J0335f

**J0336** **Cover Slip.** Ultra-thin glass. 22mm x 22mm (~1" x ~1"). 100/Box.

**J0336p** **Plastic Cover Slip.** Almost unbreakable flexible vinyl cover slip. Interleaved with tissue. 22mm W x 22mm L x 0.157mm (0.007") H. 100/box.

**J0337a** **Two Place Slide Mailer.** These two place slide protectors hold standard microscope slides securely. With large, easy to secure snaps, our propylene mailers provide safe storage for valuable slides. Bright neon assorted colors (red, yellow, blue, purple, and orange) are great for color-coding. Inexpensive. 93mm W x 68mm L x 5 mm H. 25/pkg assorted colors.



J0337a

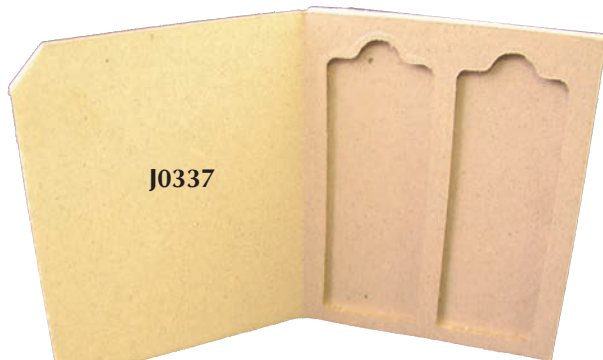

J0337

**Microscope Slide Holder/Mailer.** These sturdy cardboard slide mailers are designed for safe, easy handling of microscope slides. Reusable

- Holds standard 1" x 3" (2.5cm x 7.6cm) slides with or without cover slip
- Inner groove for easy finger removal
- Extra area for labeling information

**J0337** Cardboard Mailer. 2 slides. 2/pkg.  
**J0337L** Cardboard Mailer for 20 slides.



J0337L

**J0816x** **Plastic 5-Slide Mailer.** Ideal for shipping, storing or staining of slides. These polypropylene containers hold five standard slides. Hinged side opening with secure closure. Slotted channels for slide separation and easy removal. 5/pkg. Assorted colors.



J0816x

**Microscope Slide Storage.** JorVet provides a variety of slide storage containers. These allow for archiving and storage of interesting reference slides. They are great to retrieve for reference and educating purposes. Every clinic should develop a slide library.

**J0815 Microscope Slide Dispenser.** ABS plastic dispenser releases clean, dust-free microscope slides. Holds 72 standard slides. Turning either side wheel dispenses slides out one at a time. Unique design makes loading of microscope slides very easy. The clear plastic cover allows one to see number of slides remaining.



**J0816s Slide Storage and Index Box** provides safe storage. This slide holder set includes twelve 5" x 3" cards. You can sort, group, classify or arrange slides in any order. Each holder consists of a white plastic frame adhered to an index card. They hold 4 slides per card. Index tabs allow for reference and classification. File box constructed of sturdy gray plastic.

J0816s

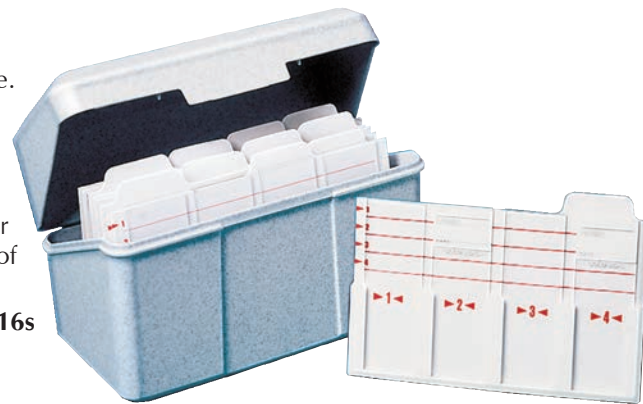

**Microscope Slide Box.** Each box has slots for each slide. A foam back secures slides. Closes via a clasp and hinge. A chart on inside cover allows for written record of each specific slide.

**J0816r 100-Place Slide Box.** Blue. 8<sup>3</sup>/<sub>4</sub>" x 6<sup>3</sup>/<sub>4</sub>" x 1<sup>3</sup>/<sub>8</sub>".

**J0816t 25-Place Slide Box.** Red. 5<sup>1</sup>/<sub>2</sub>" x 3<sup>1</sup>/<sub>2</sub>" x 1<sup>1</sup>/<sub>4</sub>".



J0816r

J0816t



**Safety Labeled Wash Bottles** ensure leak proof dispensing of your common lab solutions. Polypropylene closure is 53mm W with a leak proof design.

Easy-to-read and color-coded for content recognition and informative safety labeling:

- Printed bottle: Dept of Transportation (DOT)
- National fire protection (NFPA) codes and symbols
- Chemical abstract service number (CAS)
- Protective equipment symbols and target organ information

All this information makes your workplace safer.

**500ml (16 oz) Bottle.**

- J0817a **Bottle.** De-Ionized Water.
- J0817b **Bottle.** Distilled Water.
- J0817c **Bottle.** Saline Solution.
- J0817d **Bottle.** Sodium Hypochlorite (Bleach).
- J0817e **Bottle.** Soap.
- J0817f **Bottle.** Ethanol.
- J0817g **Bottle.** LYOB (Label Your Own Bottle).
- J0817h **Bottle.** Isopropanol.
- J0817 **Set of All Eight 500ml Bottles.**

**1,000ml (32 oz) Bottle.**

- J0817k **Bottle.** Distilled Water.
- J0817m **Bottle.** Isopropanol.
- J0817q **Bottle.** Ethanol.
- J0817r **Bottle.** LYOB (Label Your Own Bottle).
- J0817s **Set of All Four 1,000ml Bottles.**



J0818 Left  
J0818a Right

**Spray Wash Bottle.** These wash bottles have a fine-needle stream. Made of clear polyethylene.

- J0818 **Bottle.** 8 oz. 250ml.
- J0818a **Bottle.** 16 oz. 500ml.

J0827 **Safety Goggles.** Molded of soft clean flexible vinyl that conforms to the face and nose. Four vents eliminate fogging. Clean acetate lenses. Can be worn over regular glasses. 1/2"W adjustable head band.



J0827

See page 169 for additional protective eyewear.

**Three Corner Beaker.** These graduated beakers are unbreakable polypropylene with built-in pour spouts. Not affected by most chemicals. Beakers are inexpensive enough to be disposable but can be autoclaved and/or reused. 10/pk.

- J0168 **Beaker.** 50ml. 5ml graduated increments.
- J0168a **Beaker.** 400ml. 10ml graduated increments.
- J0168b **Beaker.** 1000ml. 50ml graduated increments.



J0168b J0168 J0168a



**Microhematocrit Capillary Tube.** These capillary tubes are designed for both safe blood collection as well as an accurate microhematocrit determination. Precision molded, they provide excellent sample retention during centrifugation. Tubes fill rapidly without affecting specimen integrity. Packaged in a protective snap cap vial. 100 tubes/vial. *Technical Specifications:* ID: 1.15mm  $\pm$  0.05mm; OD: 1.5mm  $\pm$  0.05mm; Length: 75mm  $\pm$  1mm; Volume: 75 $\mu$ l.

- J0542 Heparinized Tube.** Pre-calibrated tube marked with black calibration at 60 microns (micro meters) from one end.
- J0543 Red Tip.** Sodium Heparinized tube.
- J0544 Blue Tip.** Plain tube.



**J0501rc Hematocrit Reader Card.** A laminated chart necessary for determining PCV values from microhematocrit tubes.

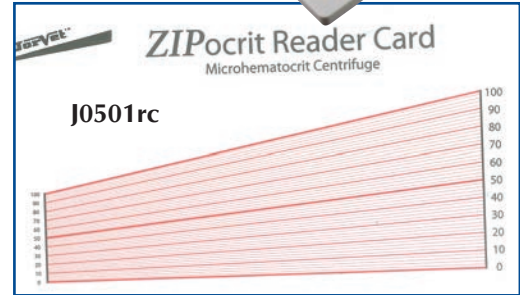

**J0545 Capillary Tube Sealant/Specimen Holding Tray.** Tip resistant tray for upright storage of 24 tubes. Leak-tight sealant formed quickly from unique compound designed to withstand centrifugation. Non-toxic, non-drying, non-hardening.

**Pipette Bulbs** help to expel the blood from the capillary or microhematocrit tube. The can also be used to draw blood from a blood collection tube instead of directly from a nail stick.

- J0545pb Pipette bulbs,** bulk 10/box.
- J0545p Pipette bulbs,** single

**Micro Hematocrit Tubes. 100% Plastic.** JorVet now offers 100% plastic microhematocrit capillary tubes that are virtually unbreakable. They eliminate the risk of injury and contamination associated with glass tubes due to breakage. Plastic microhematocrit tubes comply with FDA, NIOSH, CDC, and OSHA safety recommendations. Latex free. Packaged 100 tubes per vial.

*Technical Specifications:* ID: 0.9mm  $\pm$  0.05mm; OD: 1.6mm  $\pm$  0.05mm; Length: 75mm  $\pm$  0.05mm; Volume: 45  $\mu$ l.

Note: glass tubes have volume of 75  $\mu$ l.

- J0544p Plastic capillary tube** plain blue tip
- J0543p Plastic capillary tube** sodium heparinized red tip

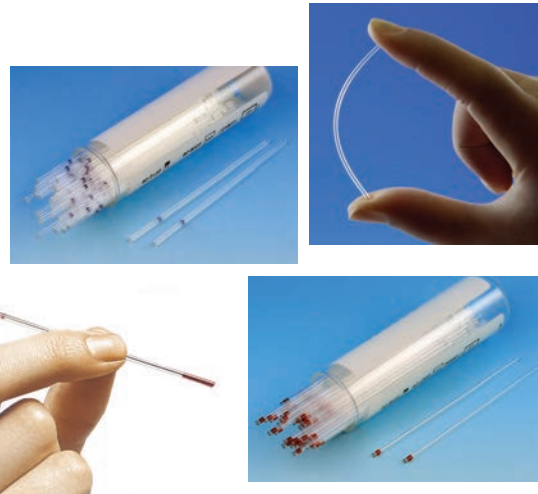

**Micro hematocrit pipette bulbs.**

- Work with all types of microhematocrit tubes
- Help to expel blood from capillary tube
- Useful for drawing blood directly from a larger blood collection tube.

- J0545p Pipette bulb each**
- J0545pb Pipette bulb,** 10pk



**Standard 75mm Microhematocrit Tube** wrapped with three layers of Mylar. Hemato-clad hematocrit tubes combine the precision of glass with the safety provided by a mylar overwrap. Accidental breakage is significantly reduced particularly when pressing into sealing clay. In the event of breakage, the Mylar wrapping will help contain the blood sample and provides an added layer of protection against cuts from broken glass. Handy dispensing vial with chrome lid.

- J0544m Standard 75mm Microhematocrit Tube.** Blue. 200 tubes/vial.
- J0543m Heparin Coated 75mm Microhematocrit Tube.** Red. 200 tubes/vial.
- J0546c Universal cap.** This cap will work on almost all laboratory test tubes. It will fit 12mm, 13mm, and 16mm test tubes. Note J-546A 15ml, centrifuge tube has a 16mm diameter opening. 100pk



**J0546e Round Bottom Centrifugal Test Tubes.** Original classic design features straight edges and no cone shape end. Polystyrene – approximately 15ml capacity. 100mm length x 17mm diameter. 100pk. Graduated markings.

**Microcentrifuge Tube.** Excellent for serum, urine, or heartworm testing. The 1.5ml tube comes with attached push cap and conical bottom. 10mm (2/5" ) x 40mm (1 3/5").

**J0548 Tube.** 100/pk.

**J0548a Tube.** 500/pk.

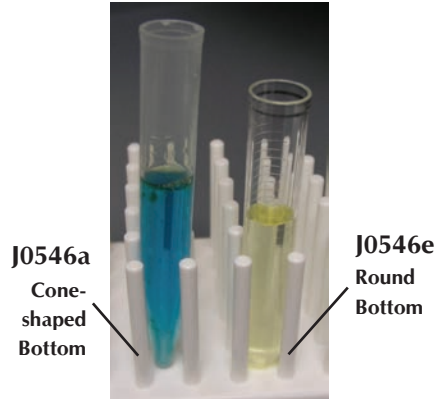

**Centrifuge Tube.** Conical shaped tube with graduations.

**J0546 Reusable Polypropylene Tube.** 15ml. Autoclavable and unbreakable. 10/pk.

**J0546a Disposable Polystyrene Tube.** 15ml. 100/box.



**Conical Centrifuge Tube.** Polypropylene centrifuge tubes are for critical lab studies. Include polyethylene screw cap with flat top for easy writing or affixing labels.

The tubes have bold, easy-to-read white graduations and a large writing area.

**J0546b Tube.** 15ml. 100/bag.

**J0546d Tube.** 50ml. 100/bag.

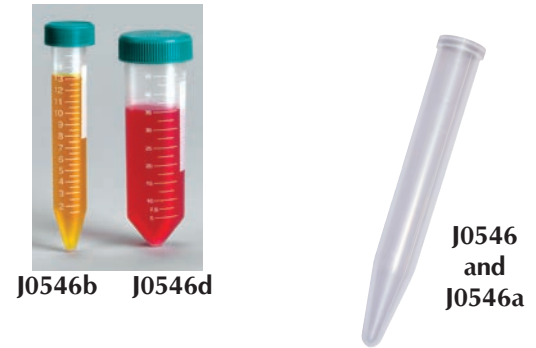

**Leukotic Plus.** Replacement for BD's Unopette™. A single use test for Microscopic counting of WBCs in whole blood. The Unopette was a long standing popular product for a number of veterinary applications. It has been discontinued, but a replacement product is now available.

**Mode of action:** Microscopical counting of white blood cells (WBCs) in a Neubauer counting slide (J-821) after lysis of the red blood cells (RBC) and fixation of the WBC nucleus. The WBC nuclei appear distinctly in front of a clear background. Gentian violet stains the WBC nucleus lightly violet-blue to further enhance their visualization.

Other applications:

- Total sperm count
- Avian RBC (nucleated)
- Spinal fluid WBC
- Synovial fluid

**Overview of Procedure:** Whole blood is collected into Microhematocrit (EDTA) tube. It is mixed into a small microcentrifuge tube with reagent. Then a small quantitative sample is placed on the Neubauer counting slide and examined under 100x magnification of a microscope. Various chambers on the Neubauer are counted and multiplied out to reach WBC or other specimen count. The entire procedure takes less than 5 minutes.

**Note:** For additional information go to [www.JorVet.com](http://www.JorVet.com) click on literature then Leukotic for FAQ concerning this product.

**J1195a 25 Leukotic Plus kits** with collection/delivery microhematocrit tubes

**J1195 100 Leukotic Plus kits** with collection/delivery microhematocrit tubes

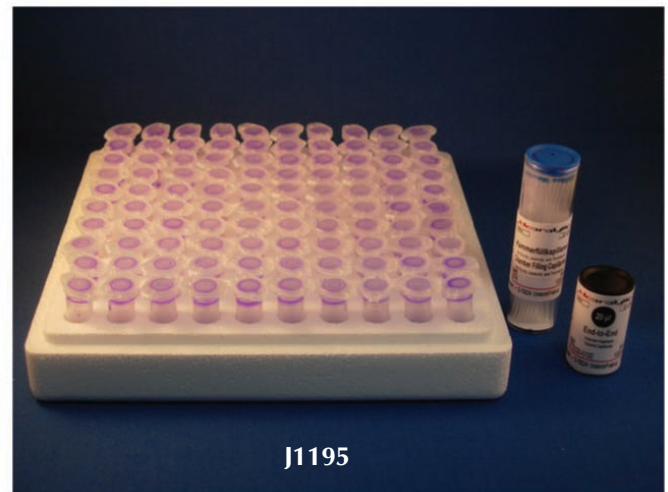

*Unopette is a trademark of Becton, Dickinson and Company.*

*Leukotic Plus is manufactured by bioanalytic GmbH-Germany, FDA registered for US market.*

**J0557 Twirl'Em Sample Bag.** The affordable sterile container. Ideal for transport of solids, semi-solids, or liquids. Similar to Whirl paks.

- Heavy-gauge transparent polyethylene
- Double bottom seam
- Can write on printed surface
- 3" x 7" (76mm x 127mm)
- 4 oz. (120ml) capacity
- 100/case

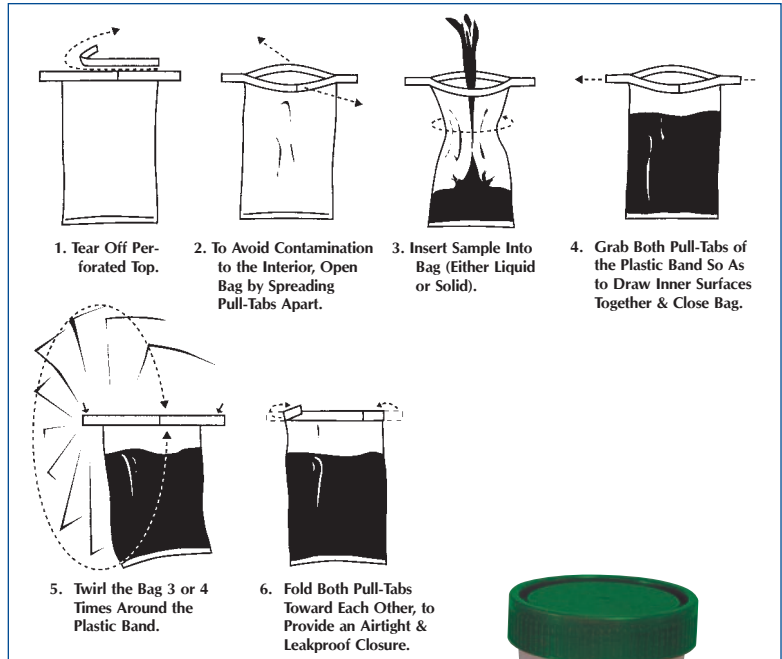

**J0555 Sterile Disposable Specimen Container.** Graduated specimen container. A leak proof lid. Wide base for stable reliable use. Seal/label assures internal sterility. Green cap. 4 oz. (120ml). 100/bag.



J0555

**J0555ns Non-Sterile Disposable Specimen Container.** Same as J-555 only non-sterile. 100/bag.

**Sterile Culture Tube.** Transparent polystyrene tubes can be used for most routine laboratory procedures. Tubes are supplied with a 2-position ribbed polyethylene cap which can be left open for aerobic work or sealed for anaerobic work. 25/bag.

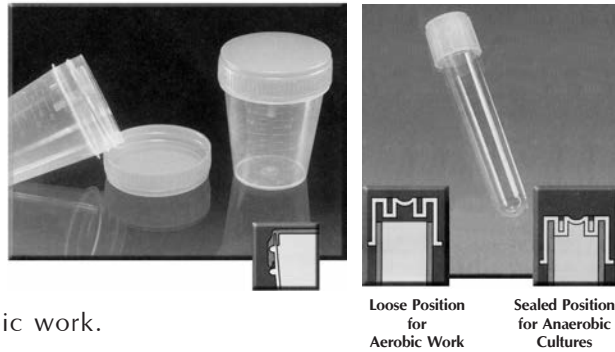

Loose Position for Aerobic Work Sealed Position for Anaerobic Cultures

**J0556a Culture Tube.** 5ml capacity. 12mm x 75mm.

**J0556b Culture Tube.** 16ml capacity. 17mm x 100mm.



J0556b

**Agar Gel Transport Swab.** Veterinarians often encounter challenging infectious cases that require a bacterial culture and antibiotic sensitivity. A quality transport swab will preserve the specimen from the patient to the laboratory, whether the lab is in the next room or in the next state. Individually wrapped, 50/carton.

Features:

- Extra-long 5<sup>1</sup>/<sub>4</sub>" swab shafts enable easier access to difficult sites without contamination
- Soft rayon swab tips are inert and non-toxic to micro-organisms and patients
- Tamper evident tube seal
- Large pre-attached label
- Non-breakable polypropylene tube with hour glass design squeezes out undesirable air harmful to fastidious bacteria, and prevents disintegration of gel column during transportation
- 5ml deep agar gel column insures maximum protection, improves sample viability, and optimizes moisture control

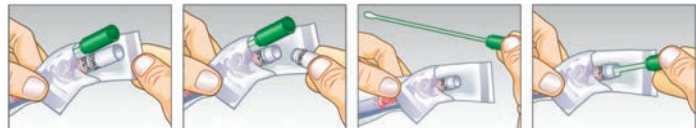

EASY TO USE Step1: Peel Apart the Plastic Film Layers. Step 2: Remove Plug from Transport Tube. Step 3: Remove Swab and Collect Specimen. Step 4: Insert Swab in Tube and Close Cap

**J0867 Amies Agar Gel Transport Swab.** Most popular. 50/carton.

**J0867a Amies Agar Gel with Charcoal Transport Swab.** 50/carton.

**J0867t Stuart's Liquid Media with Foam Sponge Transport Swab.** 50/carton.



J0867



**Dispensing Pipettor.** Pipettors are widely used in laboratories. They are an accurate method of transferring solutions or reagents. They also reduce exposure to samples or laboratory chemicals.

Consisting of two parts, a reusable pipettor draws up fluid through the disposable tip which actually holds the fluid in a preset, precise volume. The fluid never reaches or touches the actual pipettor. The disposable pipettes cost only pennies and are discarded after each use. Pipettors are available in either fixed or adjustable volume.



**Adjustable Volume Pipettor.** 200/pk.

- Easy volume setting by simply turning the plunger
- Streamlined tip for access to narrow containers and tubes

- J0855** 0.02-0.20ml ( 20-200ul) Adjustable Volume Pipettor.  
**J0855a** 0.20-1.00ml (200-1000ul) Adjustable Volume Pipettor.  
**J0855b** 1.00-5.00ml Adjustable Volume Pipettor.

**Fixed Volume Pipettor.** 200/pk.

- J0856** 0.05ml Fixed Volume Pipettor.  
**J0856a** 0.10ml Fixed Volume Pipettor.  
**J0856b** 0.50ml Fixed Volume Pipettor.  
**J0856c** 1.00ml Fixed Volume Pipettor.

**Pipette Tip.**

- J0857** 0.2ml Capacity Pipette Tip. 500/pk.  
**J0857a** 1.0ml Capacity Pipette Tip. 500/pk.  
**J0857b** 5.0ml Capacity Pipette Tip. 300/pk.

**Transfer Pipette.** General laboratory use from serum to urine. Single use clean polyethylene. Three sizes available.

- J0353** 7.0ml Pipette. 6"L. 22 drops/ml. Graduations up to 3ml. 50/pk. (Most popular size.)  
**J0353a** 7.0ml Pipette. 6"L. 22 drops/ml. Graduations up to 3ml. 500/pk. (Most popular size.)

- J0353b** 3.0ml Pipette. 5 1/2"L. 25 drops/ml. Graduations up to 1 ml. 50/pk.  
**J0353c** 3.0ml Pipette. 5 1/2"L. 25 drops/ml. Graduations up to 1 ml. 500/pk.

- J0353d** 1.7ml Pipette. 3 1/2"L. 25 drops/ml. No graduations. 50/pk.  
**J0353e** 1.7ml Pipette. 3 1/2"L. 25 drops/ml. No graduations. 500/pk.

- J0353as** 7.0ml pipette, sterile, individually wrapped. 100/box.  
**J0353cs** 3.0ml pipette, sterile, individually wrapped. 100/box.



J0353 pipettes individual pack, sterile

**Fecal Assay Kits.** JorVet, in conjunction with Dr. Don Bliss, has developed several species-specific fecal assay kits. Dr. Bliss is a noted parasitologist from Wisconsin who has lectured extensively throughout the world on parasite control. These assay kits contain everything a veterinarian or a trained lay person would need to do a large number of fecal exams at a time. It does not include a microscope or centrifuge.

**J1101ed Equine Fecal Assay Kit.**

- Sheather's sugar solution, 1 gallon
- Dosing syringe for fecal solution
- Microscope slides and coverslips
- Pet mitts for stool collection
- Wash bottle
- Fecal assay strainer
- Test tube rack
- Hand held tally counter
- Centrifuge tubes
- Surgical scissors
- Tongue depressors for stirring
- Colored equine parasite poster
- Fecal assay bucket
- Dixie cups



**J1101rd Ruminant Fecal Assay Kit.**

- Sheather's sugar solution, 1 gallon
- Dosing syringe for fecal solution
- Microscope slides and coverslips
- Pet mitts for stool collection
- Wash bottle
- Fecal assay strainer
- Test tube rack
- Hand held tally counter
- Centrifuge tubes
- Surgical scissors
- Tongue depressors for stirring
- Colored ruminant parasite poster
- Fecal assay bucket
- Dixie cups



**J1101sd Small Animal Fecal Assay Kit.**

- Sheather's sugar solution, 1 gallon
- Dosing syringe for fecal solution
- Microscope slides and coverslips
- Pet mitts for stool collection
- Contrate filters
- Wash bottle
- Fecal assay strainer
- Test tube rack
- Hand held tally counter
- Centrifuge tubes
- Surgical scissors
- Tongue depressors for stirring
- Colored small animal parasite poster
- Fecal assay bucket
- Dixie cups





**SQUEEZE TEST. The Gold Standard for Fecal Analysis.** Numerous recent university studies by CAPC have shown standard passive fecal flotation systems yield substantially **less** diagnostic ova than using a swing out centrifuge. The Squeeze Test was designed as a complete fecal diagnostic system. It complements the fecal centrifuge technique.

- Collection and transport container for clients or staff.
- Attached collections spoon for no mess sanitary handle
- Squeezable mixing chamber for sample and flotation solution
- Cap hermetically seals for safety and proper hygiene
- Built in filter screen in cap works great for filtering fecal material out and transferring ova to centrifuge test tube for centrifugation.

Also a useful aid in large animal quantitative fecal analysis together with McMaster chamber slide counting. (J-335m). The best choice for use with fecal centrifugation. [www.squeezetest.us](http://www.squeezetest.us)

**J1250 Squeeze Test Kits.** 50/bx



**J1250**  
Bottle for Squeeze Test



**1. Label container with client's name.**



**2. Collect sample with spoon provided.**



**3. Cut nozzle off with nail trimmer.**



**4. Add flotation solution.**



**5. Squeeze and mix.**



**6. Pour into test tube.**



**Acrylic Exam Glove Dispenser.** Every exam room needs these wall-mounted glove dispensers. They free up counter space and give a clean, professional image. The dispenser fits virtually all brands of latex gloves. Includes all mounting hardware. Gloves not included.

- J0876q** **Glove Dispenser.** Single box. Horizontal.
- J0876r** **Glove Dispenser.** Single box. Vertical.
- J0876s** **Glove Dispenser.** Double box. Horizontal.
- J0876x** **Glove Dispenser.** Triple box. Horizontal.

**Glove Box Holders.** Wall mount your exam gloves out of the way, but still have easy access. Attractive epoxy coated steel wire racks will hold all major brands of exam gloves. Complete with mounting screws. Gloves not included.

- J0876** **Single Box Holder.** 102mm x 140mm x 208mm.
- J0876a** **Three Box Holder.** 250mm x 96mm x 432mm.
- J0877** **Kim Wipe Holder.** Out of your way, but still at your fingertips. Mount Kim Wipes on the wall with these acrylic holders. Easily attaches with double back tape. 130mm x 84mm x 122mm.

J0876q

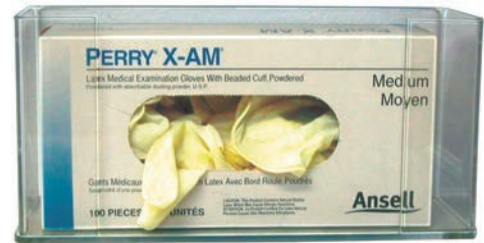

J0876



J0876a



J0877



J0876x

**Acrylic Display Rack.** Jorvet offers a range of clear acrylic display or storage racks for a wide range of clinic needs. Many can be wall mounted to save counter space and reduce clutter. Clean only with mild soap and water.

- J0885** **Blood Tube Rack.** Organize your blood collection tubes. This rack can hold over 200 tubes in various compartments. Separate tubes by color and size. It can be wall mounted or placed on a counter top. 12"W x 16"H x 5 1/2"D.

- J0812** **Stat Tracker.** This is a clever device for helping keep track of timed lab tests. The green light illuminates during the start process, at the halfway point the yellow light illuminates, and then the red light for the final alert. Select between six audible alerts. Time displayed on dual-line, 10-digit LCD. Operates on 110AC. Measures 4 1/2" x 4 1/2" x 9 1/4".

J0812



J0885

**Formalin-Filled Jar.** Biopsy and tissue samples need to be handled properly for the best results. These clear polystyrene containers are prefilled with 10 percent phosphate buffered formalin. The screw caps are lined polyethylene that are leak tight and grooved for secure handling. In accordance with OSHA requirements, the containers are affixed with warning labels containing sufficient space for writing patient's name, specimen description, and the veterinarian's name.

- J0552 Jar.** 15ml capacity. 1" dia. 1<sup>7</sup>/<sub>16</sub>"H 10/pk.
- J0552a Jar.** 30ml capacity. 1" dia. 3<sup>1</sup>/<sub>2</sub>"H 10/pk.
- J0552b Jar.** 60ml capacity. 1<sup>5</sup>/<sub>8</sub>" dia. 2<sup>3</sup>/<sub>8</sub>"H 10/pk.
- J0552c Jar.** 120ml capacity. 2" dia. 2<sup>5</sup>/<sub>8</sub>"H 10/pk.



**J0552 Series**

**J1148 Slide Staining Tray.** Certain stains such as the Gram stain work best with a staining tray. The slides are suspended just above a drain tray. Then slides are rinsed and excess stain is collected below for disposal. Polypropylene/polyethylene blend. Holds up to 8 slides. Dark lid. 305 x 12 x 29.5mm. 4 base tray lids.



**J1148**

**Test Tube Cleaning Brushes.** Several different sizes available. Can be used in a variety of other cleaning procedures around the clinic such as surgical instruments.

- J1094 Small Brush.** 3" long x 1/2" diameter. Total length 8". Tube size 9–13cm. Medium stiff white nylon on galvanized wire.
- J1094a Medium Brush.** 3 1/2" long x 3/4" diameter. Total length 11". Tube size 1–25cm. Medium stiff white nylon on galvanized wire.
- J1094b Large Brush.** 3 1/2" long x 7/8" diameter. Total length 9 1/2".
- J1094c Conical Centrifuge tube brush.** Unbleached white hog bristles on galvanized wire with fan style tip. Brush 3 1/2" long, 1/2" diameter at the tip tapering to 13/16". Total length 9".
- J1094d Microbrush.** Soft white nylon on galvanized wire. Brush 2 1/2" long x 1/4" diameter. Total length 6".
- J1094s Set of all 5 brushes.**



**J1094a**



**J1094**



**J1094c**



**J1094d**

**J1037 Push-up-box for Kimwipes®.** The PUSH-UP-BOX™ has been designed to give perfect dispensing of laboratory Kimwipes. The PUSH-UP-BOX™ prevents the top most tissue from falling back into the Kimwipes box. No installation necessary. Also works with JorVet lab wipes J-869. Double High Impact polystyrene, Weight 9.6 oz. Kimwipes® is a trade mark of Kimberly Clark



Remove perforated oval on bottom as well as top



Align bottom opening with push-up column



Tissues stay at the top of box down to the very last one



No more digging for tissues

**J1049 Biopsy Embedded Cassettes.** Small biopsy samples can get lost in a formalin jar and must be 'fished out'. These biopsy cassettes hold and contain the sample while it is immersed into a formalin jar. The sample can then be processed at the histopath lab through their automated equipment right in these cassettes. Orange. 50/pk. Needs to be at least a 60ml formalin jar to fit cassette.



**J1049**



**Small Animal Feeding Tube.** Red latex rubber with two opposing lateral eyes. X-ray opaque. Sterile. Improved over red vinyl tubes because it is bio-compatible and allows more patient comfort with less rigidity. Can be reused and reautoclaved. 40cm (16"). 5/pk.

<b>J0347a</b>	<b>Tube.</b> 8fr.	<b>J0347h</b>	<b>Tube.</b> 18fr.
<b>J0347b</b>	<b>Tube.</b> 10fr.	<b>J0347e</b>	<b>Tube.</b> 20fr.
<b>J0347c</b>	<b>Tube.</b> 12fr.	<b>J0347f</b>	<b>Tube.</b> 24fr.
<b>J0347cc</b>	<b>Tube.</b> 14fr.	<b>J0347g</b>	<b>Tube.</b> 28fr.
<b>J0347d</b>	<b>Tube.</b> 16fr.		

These tubes work well with the **J-51k-n** stomach tube speculums.

**Small Animal Nasogastric Feeding Tube.** These small animal feeding tubes are useful in longer term nasogastric oral supplementation. Transparent plastic. Rounded closed tip with two opposing lateral eyes. Luer syringe connector with attached plug. Sterile. 5/pk.

<b>J0348a</b>	<b>Tube.</b> 5fr x 15".	Cat and dogs.
<b>J0348b</b>	<b>Tube.</b> 8fr x 15".	Medium dogs.
<b>J0348c</b>	<b>Tube.</b> 5fr x 39".	
<b>J0348d</b>	<b>Tube.</b> 8fr x 42".	

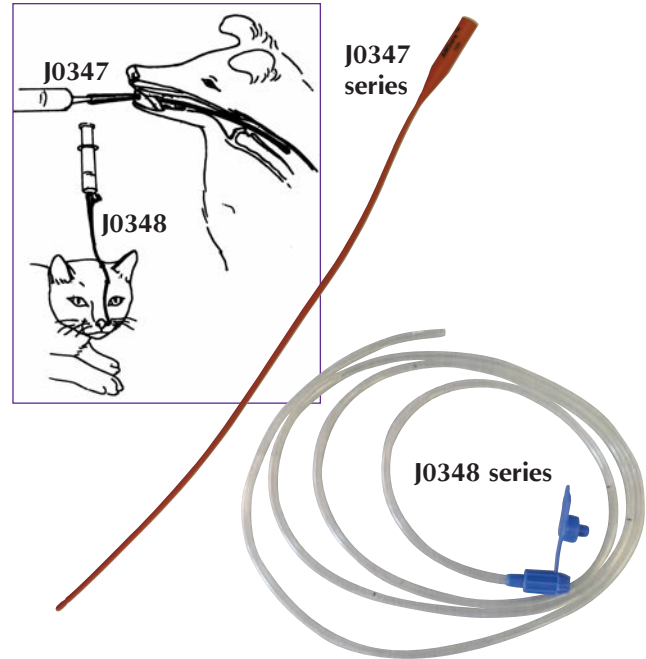

**J0051k Feline Stomach Tube Speculum.** Smaller size works well on cats and smaller dogs. 6mm opening. 18fr.

**J0051m Canine Stomach Tube Speculum.** Speculum is useful for passing stomach tube in the conscious patient. The speculum is held in check by the canine teeth going through the two large holes. A 3/8" round hole through the center allows a stomach tube to pass through. By holding jaws firmly closed any chance of biting the tube is eliminated. The hardened blue nylon resists chewing and can be cold sterilized for reuse. 9mm opening. 27fr.

**J0051n Large Canine Stomach Tube Speculum.** 6" x 2" will take up to a 3/8" stomach tube.

**J0106a Canine Stomach Tube.** Designed to facilitate the removal or location of esophageal obstructions. The rounded ends allow for atraumatic passage while the metal ball marker assists in the location of any obstruction by X-ray methods. The lateral eye allows for aspiration of gastric contents or administration of fluids. This item is a great addition to any veterinary clinic. 24fr x 76cm.

**J0106b Canine Stomach Tube.** 36fr x 76cm.

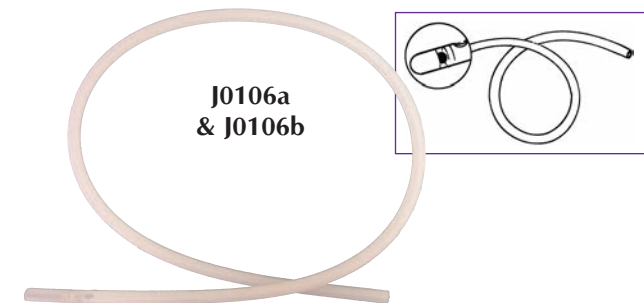
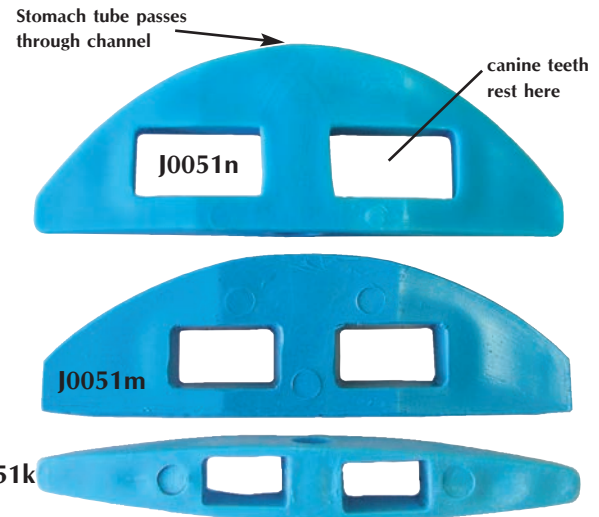

**Esophagostomy Tube.** Tubes for long term placement of esophagostomy tubes.

- Soft silicone
- Bio-compatible
- Luer fitting
- Retention cap always attached
- Cut to desired length
- Non-sterile
- Packaged individually in chevron pouch

**J0390 Esophagostomy Tube.** 14fr x 9". For cats and small dogs.

**J0390L Esophagostomy Tube.** 19fr x 15". For dogs.

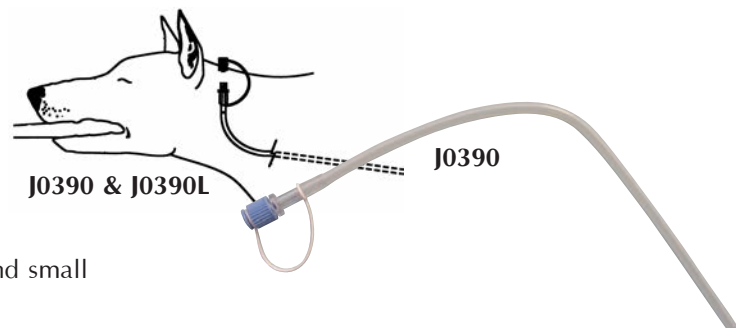



**J1083 Esophagostomy Tube Insertion Device.** This instrument makes esophageal tube placement simple and quick. The device is inserted into the oral cavity and started down the esophagus. An incision is made mid-cervical over the instrument. The esophagostomy tube is inserted into the instrument and it passes safely and precisely down the esophagus like a 'shoe horn principle.' The tube is sutured or taped in place and the patient can immediately be fed following recovery from anesthesia. Detailed instructions included with each instrument. Includes 10 tubes 15fr x 50cm. DVD available or visit [www.JorVet.com](http://www.JorVet.com).



J1083

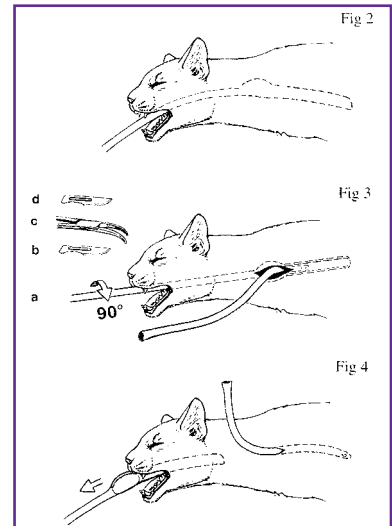

**J1083t Tube Only.** 15fr x 50cm. Each.

**Kitty Kollar®. "E" Tube protective collar.** The collar was designed to be a sensible solution to the everyday patient management of an esophagostomy tube (e-tube) in the cat and dog. The adjustable collar fits securely around the animal's neck, with a hole for the tube and a Velcro™ strap to secure it when it is not in use. Circular cotton pads are supplied to place between the collar and the skin, protecting the wound to absorb drainage from below and protect from contaminants from above. It eliminates the need for owners to attempt to learn bandaging techniques, as well as unnecessary repeated visits to your office for re-bandaging. Primary benefits include:

- Machine washable collars provide superior cleanliness of site
- Ease of application and removal (=convenience)
- Lowered risk of tube removal by animal
- Decreased risk of wound trauma (animals scratch at site less; less chance that owners will bandage too tightly and restrict breathing)
- Can leave in place for Radiographs, MRI, chemotherapy, other procedures
- Aesthetically pleasing for "squeamish" clients
- Send home a more professional and compassionate presentation

Each collar is packaged in a plastic bag with a laminated information card, and comes with 6 protector pads (a one-to two week supply).



J1085

**Kitty and Kanine Kollar Size Chart**

Product Code	Collar Size	Animal (Example Breeds)	Est. Weight	Neck Size	Length in Inches Collar + Tab	Width in Inches	End of Collar to Tube Hole	Top Edge of Collar to Tube Hole
J1085x	XS	Toy Dogs/Kittens Chihuahua, Yorkie	4-7#	4-7"	5.5+2"	2"	1.5"	¾"
J1085	Petite	Small Cats/Dogs Yorkie, Poodle	6-9#	8-9"	9 +2"	2"	1.5"	¾"
J1085a	Small	Cat/Small Dog, Lhasa, Peke, Small Terriers	10-16#	10-12"	11 +2"	2"	1.5"	¾"
J1085b	Medium	Mixed Breeds, Doberman, Greyhound	14-50#	12-16"	13 +3"	3"	3"	1"
J1085c	*Large	Large-Medium Breed: Lab, Blood Hound, Chow, Shepherd	55-90#	17-19"	18.5 +3"	4"	4.5"	2"
J1085d	*X Large	Large Breeds, Rottweiler, Akita, Lab, Golden	93-120#	20-24"	21+3.5"	4"	4.5"	2.5"

Note: Long-haired breeds may need to go up a size

\*Double Velcro Strip on Large and X-Large size. Velcro that covers tube goes up halfway on first three sizes; all the way on three largest sizes for additional security of tube.

Distance from hole to Velcro flap one inch standard on all sizes

**J1085p Protector Pads.** Package of 24 (1-2 month supply)



Velcro to hold collar  
Hole for "E" tube  
Velcro to end of tube in place

U.S. Pat. No. 8,539,912

Visit [www.JorVet.com](http://www.JorVet.com) for an instructional video.

J0389  
and  
J0389L



**ELD Gastrostomy Tube Applicator.** Percutaneous gastrostomy nutritional supplementation is an easy and practical way to feed an anorexic cat or dog. With the advent of special diets like Hill's Prescription A/D and other syringeable diets, many previously terminal cases can be saved. However, until now, the only way to place a gastrostomy tube properly was with the aid of a fiberoptic endoscope.

JorVet introduces the ELD Applicator that allows the percutaneous insertion of a gastrostomy feeding tube.

**Figure 1.**

Stainless steel instrument is gently passed down the esophagus into the stomach.

**Figure 2.**

A plunger on the distal end pushes out a retracted eyed needle that penetrates the abdominal wall. The eye portion of the needle is threaded with the suture and the whole instrument is gently removed while pulling the suture out the esophagus and mouth.

The portion of the suture protruding out of the mouth is threaded through a Tom cat catheter and attached to the end of a 14fr rubber feeding tube.

**Figure 3.**

The rubber modified feeding tube is then pulled down the esophagus and out the abdominal wall by gently pulling on the suture end protruding from the stomach wall.

**Figure 4.**

The gastrostomy tube is left in place for weeks. The animal is supplemented with specialized diet like Hill's A/D until it begins to eat on its own. It is easy for the owner to feed and take care of the patient at home.

The gastrostomy tube is easily removed. Stabilize the abdominal wall with the thumb and index finger, then simply pull the tube out, allowing the anchor piece and rubber band to fall into the stomach.

**J0389 ELD Gastrostomy Tube Applicator** for cats and small dogs. 18" shaft.

**J0389L ELD Gastrostomy Tube Applicator** for large dogs. 32" shaft.

*Recommend using Pezzer catheters,  
J0446 Series, page 311.*

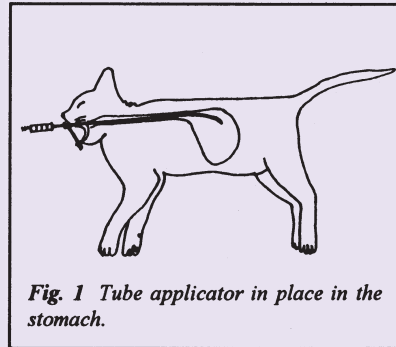
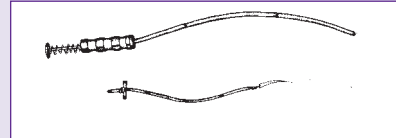

**Fig. 1** Tube applicator in place in the stomach.

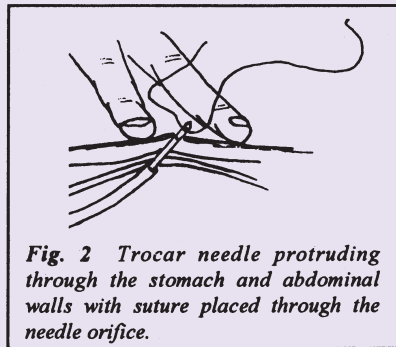

**Fig. 2** Trocar needle protruding through the stomach and abdominal walls with suture placed through the needle orifice.

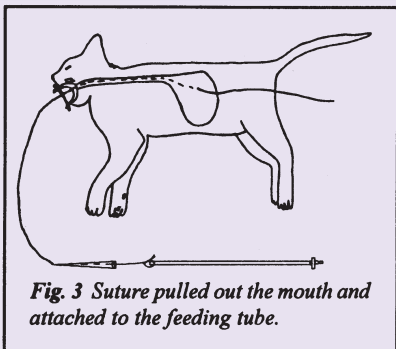

**Fig. 3** Suture pulled out the mouth and attached to the feeding tube.

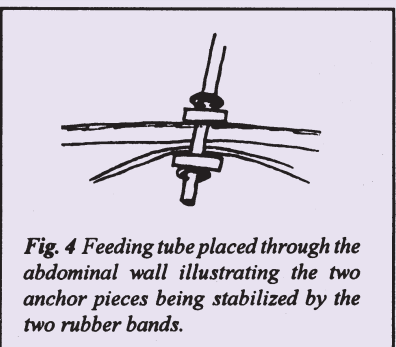

**Fig. 4** Feeding tube placed through the abdominal wall illustrating the two anchor pieces being stabilized by the two rubber bands.

**Large K-9 Stomach Tube.** Larger size PVC stomach tube for bigger dogs. Useful in gastric lavage or administering larger volumes of fluids with special funnel adaptor. Plus has one lateral eye.

**J0348q Stomach Tube.** Medium. 1/4" i.d. x 3/8" o.d. x 3 1/2'. For dogs ≥40 lbs.

**J0348r Stomach Tube.** Large. 5/16" i.d. x 1/2" o.d. x 4'. For dogs ≤70 lbs.

NOTE: Similar to J-106 Equine Tubes.



**J0988 Silicone Acute Peritoneal Dialysis Catheter.** In an emergency situation where peritoneal dialysis needs to be performed, this catheter is invaluable. The distal tip has a number of fenestrations for widespread drainage, plus is covered by a loose fitting dacron mesh that helps avoid obstructing these fenestrations. Sterile. 15fr (5mm) x 80cm. Distal portion is 16mm o.d.



**Silicone Gastric Feeding Tube.**

- Bullet point/cap for luer fitting
- Lateral eye along numerous spots (4)
- Graduated marking
- Can be used long term
- Sterile

**J0385d Feeding Tube.** 6fr. 2.0mm o.d. x 40cm.

**J0385 Feeding Tube.** 8fr. 2.7mm o.d. x 70cm.

**J0385a Feeding Tube.** 12fr. 4.0mm o.d. x 120cm.

**J0385b Feeding Tube.** 16fr. 5.3mm o.d. x 120cm.

**J0385c Feeding Tube.** 20fr. 7.3mm o.d. x 120cm.

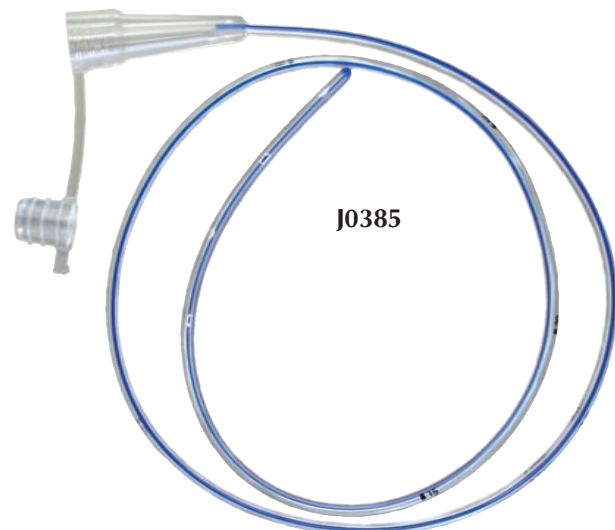





**Malecot 4-Wing Catheter.** Amber latex rubber; 4-wing tip that collapses. Funnel end. Sterile.

- J0445a Catheter.** 10fr x 14".
- J0445b Catheter.** 14fr x 14".
- J0445c Catheter.** 16fr x 14".



**Pezzer Catheter.** Amber latex with mushroom tip. Sterile.

- J0446g Catheter.** 12fr x 13".
- J0446b Catheter.** 14fr x 13".
- J0446c Catheter.** 16fr x 13".
- J0446d Catheter.** 18fr x 13".
- J0446e Catheter.** 20fr x 13".
- J0446f Catheter.** 24fr x 13".

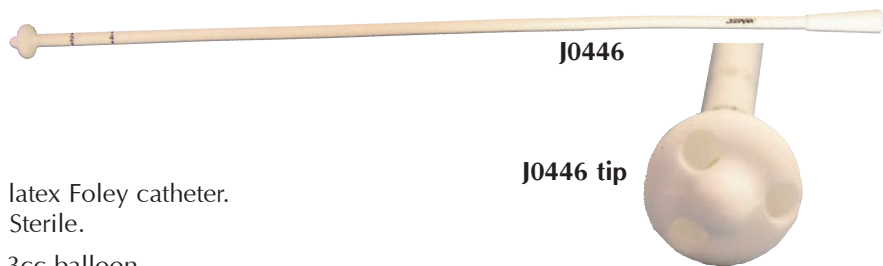

**Foley Catheter.** Silicone-coated amber latex Foley catheter. 2-way with opposed lateral eyes at tip. Sterile.

- J0447a Catheter.** 8fr x 12" with 3cc balloon.
- J0447b Catheter.** 10fr x 12" with 3cc balloon.
- J0447c Catheter.** 12fr x 16" with 5cc balloon.
- J0447d Catheter.** 14fr x 16" with 5cc balloon.
- J0447e Catheter.** 16fr x 16" with 5cc balloon.
- J0447f Catheter.** 18fr x 16" with 5cc balloon.
- J0447g Catheter.** 20fr x 16" with 5cc balloon.
- J0447h Catheter.** 22fr x 16" with 5cc balloon.
- J0447s Catheter.** 6fr x 12" with 3cc balloon.



**Foley Catheter, Equine Use.** Excellent for uterine flushes. Sterile.

- J0447q Catheter.** 26fr x 16" with 30cc balloon.
- J0447r Catheter.** 30fr x 16" with 30cc balloon.

Large Silicone Foley Stallion Catheters.

- J0693sc Catheter.** 28fr x 150cm with 5cc balloon.
- J0693sd Catheter.** 12fr x 150cm with 5cc balloon.

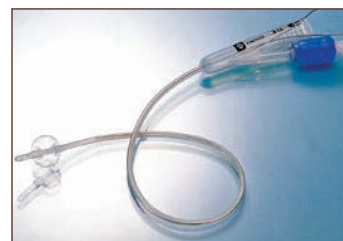

**Silicon Foley Catheter.** Silicone is the preferred material for foley catheters. This catheter softens at body temperature. Equipped with a one-way valve for balloon inflation. Sterile.

<b>J0693</b>	<b>Catheter.</b>	5fr o.d. x 30cm L.		Clear.
<b>J0693a</b>	<b>Catheter.</b>	6fr o.d. x 30cm L.	1.5cc balloon w/styler	Clear.
<b>J0693b</b>	<b>Catheter.</b>	8fr o.d. x 30cm L.	3cc balloon w/styler	Clear.
<b>J0693c</b>	<b>Catheter.</b>	10fr o.d. x 30cm L.	3cc balloon w/styler	Clear.
<b>J0693d</b>	<b>Catheter.</b>	12fr o.d. x 40cm L.	5cc balloon	Clear.
<b>J0693e</b>	<b>Catheter.</b>	14fr o.d. x 40cm L.	5cc balloon	Clear.
<b>J0693f</b>	<b>Catheter.</b>	16fr o.d. x 40cm L.	5cc balloon	Clear.
<b>J0693g</b>	<b>Catheter.</b>	18fr o.d. x 40cm L.	5cc balloon	Clear.
<b>J0693h</b>	<b>Catheter.</b>	20fr o.d. x 40cm L.	5cc balloon	Clear.
<b>J0693j</b>	<b>Catheter.</b>	22fr o.d. x 40cm L.	5cc balloon	Clear.
<b>J0693m</b>	<b>Catheter.</b>	26fr o.d. x 40cm L.	5cc balloon	Clear.
<b>J0693w</b>	<b>Catheter.</b>	5fr o.d. x 55cm L.	2cc balloon	Clear.
<b>J0693x</b>	<b>Catheter.</b>	8fr o.d. x 55cm L.	3cc balloon	Clear.
<b>J0693y</b>	<b>Catheter.</b>	10fr o.d. x 55cm L.	3cc balloon	Clear.
<b>J0693wL</b>	<b>Catheter.</b>	6fr o.d. x 90cm L.	1.5cc balloon	Clear. with styler
<b>J0693xL</b>	<b>Catheter.</b>	8fr o.d. x 90cm L.	3.0cc balloon	Clear. with styler
<b>J0693yL</b>	<b>Catheter.</b>	10fr o.d. x 90cm L.	3.0cc balloon	Clear. with styler

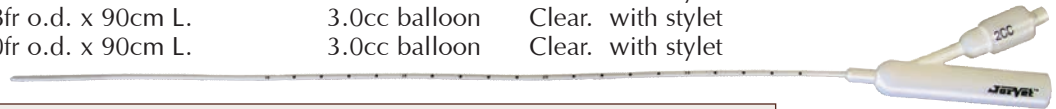

*NOTE: Balloon should be filled with sterile water or saline for best long-term results.*

**Pezzar Catheters.** Great for PEG feeding tubes. Mushroom tip assists in catheter retention, with 2cm and 4cm markings from tip's base to aid in proper catheter placement. Soft silicone. 36 cm (16") L. Sterile.

<b>J0446m</b>	<b>Catheter.</b>	16fr o.d. 3.2mm i.d. 5.3mm o.d.	feline and small dogs.
<b>J0446n</b>	<b>Catheter.</b>	16fr o.d. 3.2mm i.d. 5.3mm o.d.	X-Large 20mm dia. tip. feline and small dogs
<b>J0446p</b>	<b>Catheter.</b>	20fr o.d. 4.0mm i.d. 6.7mm o.d.	med/large dogs
<b>J0446r</b>	<b>Catheter.</b>	22fr o.d. 4.0mm i.d. 7.3mm o.d.	X-Large 25mm dia. tip. med/large dogs



**Enteral/Nasogastric Feeding Tubes.** These silicone feeding tubes are great for administering medication and other fluids orally or nasally. All catheters are fully autoclavable. Lateral eyes are on distal tip. Hinged-attached cap. Sterile.

<b>J0386</b>	<b>Tube.</b>	3.5fr o.d.	1.3mm o.d.	20cm L.
<b>J0386a</b>	<b>Tube.</b>	5.0fr o.d.	1.7mm o.d.	20cm L.
<b>J0386b</b>	<b>Tube.</b>	5.0fr o.d.	1.7mm o.d.	35cm L.
<b>J0386c</b>	<b>Tube.</b>	6.0fr o.d.	2.0mm o.d.	55cm L.
<b>J0386d</b>	<b>Tube.</b>	8.0fr o.d.	2.7mm o.d.	40cm L.
<b>J0386e</b>	<b>Tube.</b>	8.0fr o.d.	2.7mm o.d.	55cm L.
<b>J0386f</b>	<b>Tube.</b>	8.0fr o.d.	2.7mm o.d.	75cm L.
<b>J0386g</b>	<b>Tube.</b>	8.0fr o.d.	2.7mm o.d.	120cm L.
<b>J0386j</b>	<b>Tube.</b>	10.0fr o.d.	3.3mm o.d.	55cm L.
<b>J0386k</b>	<b>Tube.</b>	10.0fr o.d.	3.3mm o.d.	150cm L.
<b>J0386m</b>	<b>Tube.</b>	14.0fr o.d.	4.7mm o.d.	120cm L.

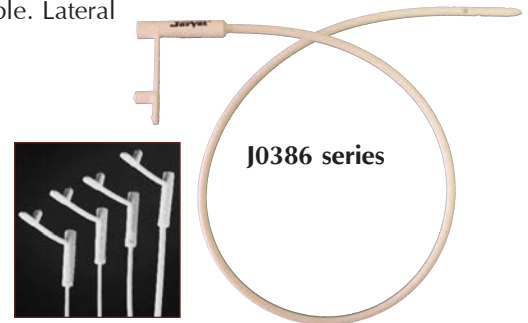

**Enteral Feeding Products.** This line of products is especially designed for mid-long term enteral feeding. Features of polyurethane feeding tubes: More durable and longer lasting than PVC tubes; Weighted tip with metal tungsten guide end for ease of placement and retention; Stylets included on all sizes; Radiopaque and non-sterile; Many of these tubes will move by peristaltic action to the jejunum after placement in the stomach, which requires longer lengths than standard feeding tubes; Numerical graduations on side of the tube; and Complete directions come with the product.



<b>J0350a</b>	<b>Feeding Tube.</b>	5fr x 22" (56cm)L.	No weighted tip.
<b>J0350b</b>	<b>Feeding Tube.</b>	6fr x 22" (56cm)L.	Weighted tip.
<b>J0350c</b>	<b>Feeding Tube.</b>	6fr x 36" (92cm)L.	Weighted tip.
<b>J0350d</b>	<b>Feeding Tube.</b>	8fr x 22" (56cm)L.	Weighted tip.
<b>J0350e</b>	<b>Feeding Tube.</b>	8fr x 36" (92cm)L.	Weighted tip.
<b>J0350f</b>	<b>Feeding Tube.</b>	8fr x 43" (56cm)L.	Weighted tip.
<b>J0350g</b>	<b>Feeding Tube.</b>	10fr x 36" (92cm)L.	Weighted tip.
<b>J0350h</b>	<b>Feeding Tube.</b>	10fr x 43" (108cm)L.	Weighted tip.
<b>J0350j</b>	<b>Feeding Tube.</b>	10fr x 55" (138cm)L.	Weighted tip.
<b>J0350k</b>	<b>Feeding Tube.</b>	12fr x 43" (108cm)L.	Weighted tip.

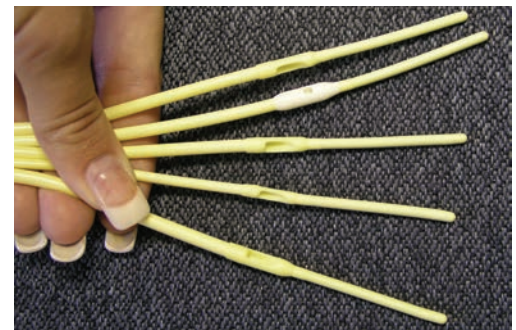

**Stomach Feeding Tubes** for small and large animals. These silicone stomach tubes are for cats and dogs; larger sizes are designed for equine or other large animal use. Constructed of clear tubing with hinged double proximal cap which allows either attaching a luer syringe or standard catheter fitting. Also features an open-ended single luer and distal lateral eyes. Fully autoclavable. Nonsterile.

<b>J0385e</b>	<b>Tube.</b>	14fr o.d.	3.0mm i.d.	4.7mm o.d.	91cm (36") L.
<b>J0385f</b>	<b>Tube.</b>	18fr o.d.	4.0mm i.d.	6.0mm o.d.	91cm (36") L.
<b>J0385g</b>	<b>Tube.</b>	24fr o.d.	5.0mm i.d.	8.0mm o.d.	18cm (7") L.
<b>J0385m</b>	<b>Tube.</b>	42fr o.d.	9.0mm i.d.	14.0mm o.d.	300cm (120") L.
<b>J0385p</b>	<b>Tube.</b>	73fr o.d.	17.0mm i.d.	24.0mm o.d.	300cm (120") L.

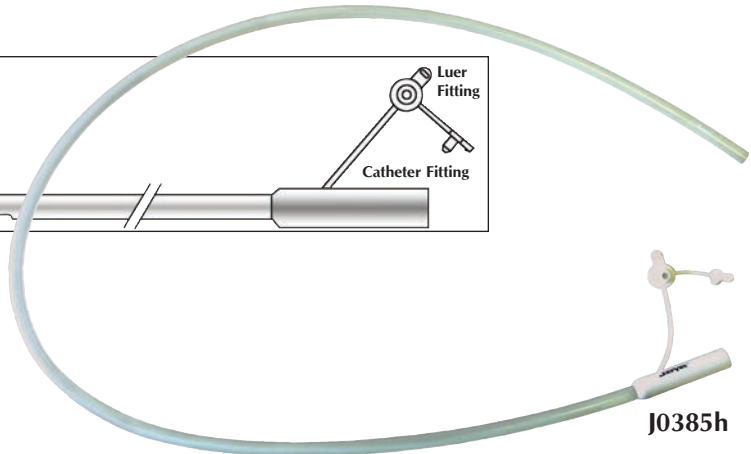
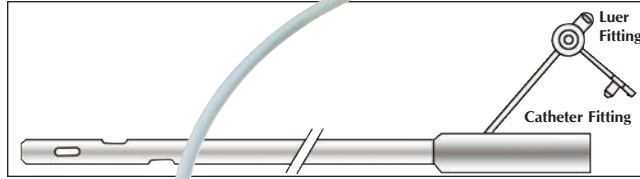

**Lightweight Thirsty Stomach Pump.** Administering oral fluids to large animals requires a reliable and fast acting stomach pump.

Traditional metal stomach pumps have had two problems:

1. Required replacement of "O" rings or felt washers after use. These pumps will leak if the "O" rings or felt washers are worn.
2. Metal pumps have a stomach tube attachment that does not fit common stomach tubes with a funnel end fitting. The stomach tube needs to be held in place or trimmed to fit the pump's attachment.

The new JorVet lightweight stomach pump addresses these two issues: No "O" rings or washers, and the funnel end of the stomach tube snaps on tight to pump adaptors.

The pump is very lightweight plastic, but durable for all weather use. The "Thirsty" pump has a stroke volume of eight ounces and delivers fluid on both up and down strokes.

The pump has two adaptors for stomach tube attachments. The smaller adaptor attaches foal and small tubes. The larger adaptor attaches medium and large stomach tubes.

**J0136 Thirsty Pump.** 7.2 oz.  
20 1/4" H. 1 1/2" dia.  
Upstroke 180cc,  
Downstroke 60cc

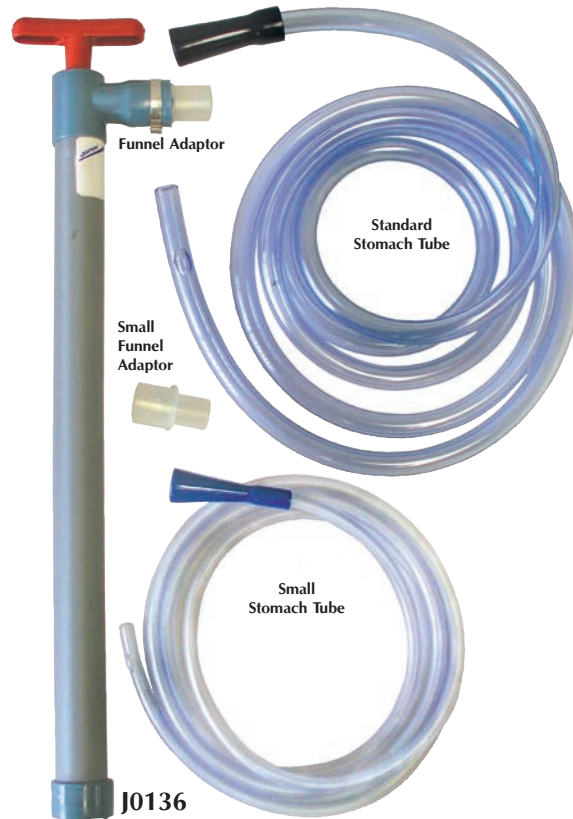

**J0132d16 Stomach Pump/Tube Adaptor.** The barbed end of the standard stomach pump (J0132) has a tapered barb end. Most stomach tubes have a funnel proximal end. This adaptor connects the pump and stomach tube. Clear PVC tubing 3" long.

**NEW**



**J0132**

**Drench Pump** for administering large doses of fluid orally. A continuous flow pump that puts out liquid on both the up and down stroke. Upstroke 60cc, downstroke 44cc





J1295

**Skater™ All-Purpose Pig tail Drainage Catheter**

- Polyurethane Catheter material is kink resistant
- Large skived drains holes for max drainage
- Includes both pointed metal trocar
- Female luerlock connection

**J1295 Drainage Catheter 6fr x 20cm with locking pig-tail.** Locks pigtail into position

**J1295a Drainage Catheter 6fr x 20cm without locking pigtail**



J1295a

**Skater™ Centesis Catheters**

- Designed for percutaneous fluid aspirations and drainage procedures
- Hollow insertion needle allows aspiration of fluid before removal of stylet
- Four side holes on distal tip facilitate drainage within side cavities

**J1296 4fr x 10cm**

**J1296a 5fr x 20cm**



J1296

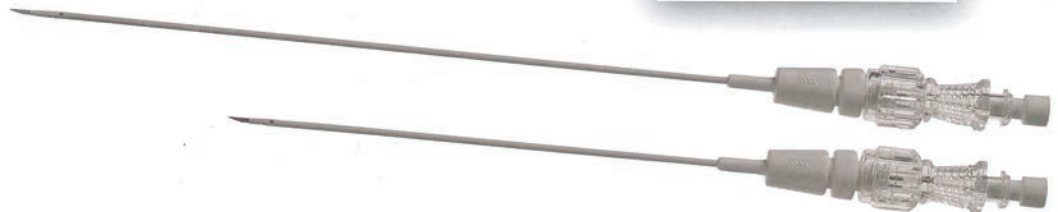

**J0350ae Equine Nasolacrimal Catheter.** Useful for flushing and maintaining the lacrimal duct system. Pass up the false nostril and into lacrimal canal.

- 5fr x 22"
- Stylet
- Polyurethane with bullet tip and one lateral eye

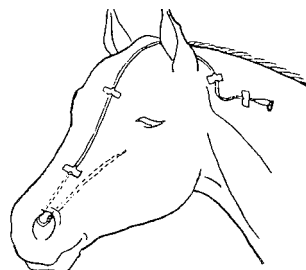

J0350ae

**Portex Equine Stomach Tube.** This is the finest quality tube on the market. Made from special siliconized PVC tubing, it has just the right amount of flexibility; it won't become rigid in cold weather and will not soften or kink in hot weather. Each tube has a funnel end to make attachment to a drench pump quick and easy.

<b>J0106f</b>	<b>Tube.</b> Foal.	1/4" i.d.	3/8" o.d. x 7'L.
<b>J0106s</b>	<b>Tube.</b> Small.	5/16" i.d.	1/2" o.d. x 9'L.
<b>J0106m</b>	<b>Tube.</b> Medium.	3/8" i.d.	5/8" o.d. x 9'L.
<b>J0106L</b>	<b>Tube.</b> Large .	1/2" i.d.	3/4" o.d. x 10'L.



**PVC Stomach Tube.** Inexpensive standard PVC stomach tubes with funnel end.

<b>J0106fe</b>	<b>Tube.</b> Foal.	1/4" i.d.	3/8" o.d. x 7'L.
<b>J0106se</b>	<b>Tube.</b> Small.	5/16" i.d.	1/2" o.d. x 9'L.
<b>J0106me</b>	<b>Tube.</b> Medium.	3/8" i.d.	5/8" o.d. x 9'L.
<b>J0106Le</b>	<b>Tube.</b> Large.	1/2" i.d.	3/4" o.d. x 10'L.



**E-Z Swallow Stomach Tube.** With no funnel end, just slightly expanded to fit stomach pumps and dose syringes better. Manufactured from the same superior grade of material as the familiar "Portex" brand tubes.

<b>J0106fg</b>	<b>Tube.</b> Foal.	1/4" i.d.	3/8" o.d. x 7'L.
<b>J0106sg</b>	<b>Tube.</b> Small.	5/16" i.d.	1/2" o.d. x 9'L.
<b>J0106mg</b>	<b>Tube.</b> Medium.	3/8" i.d.	5/8" o.d. x 9'L.
<b>J0106Lg</b>	<b>Tube.</b> Large.	1/2" i.d.	3/4" o.d. x 10'L.



**EquiVet Polyurethane Stomach Tube.** These all weather tubes give a little more stiffness with longer length for easy passing into the esophagus. The proximal end of the tube has a flared tip especially designed to attach to the standard metal stomach pump's barbed fittings. The distal tip is highly polished.

<b>J0106fx</b>	<b>Tube.</b> Foal.	9mm o.d.	2.60m (8 <sup>3</sup> / <sub>8</sub> 'L).
<b>J0106sx</b>	<b>Tube.</b> Small.	13mm o.d.	3.2m (10 <sup>1</sup> / <sub>4</sub> 'L).
<b>J0106mx</b>	<b>Tube.</b> Medium.	16mm o.d.	3.6m (11 <sup>1</sup> / <sub>2</sub> 'L).
<b>J0106Lx</b>	<b>Tube.</b> Large.	19mm o.d.	3.6m (11 <sup>1</sup> / <sub>2</sub> 'L).



**J0106x** **EquiVet Large Volume Funnel** is a large, over-sized funnel with a special barbed fitting that attaches firmly to stomach tubes.

**J0132L** **Large Heavy Duty Stomach Pump.** 400cc per up stroke and 220cc per down stroke. Excellent for large volume of fluids in a short time. Three times the volume per stroke versus standard pumps. Separate handle to help brace pump upright when using.

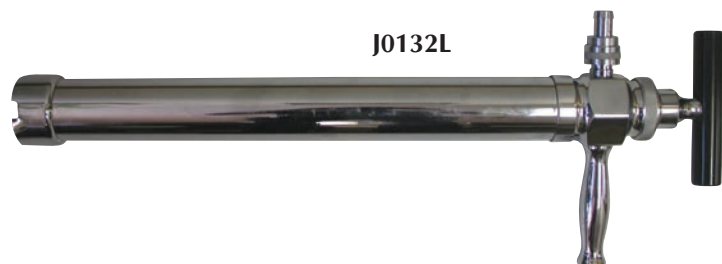

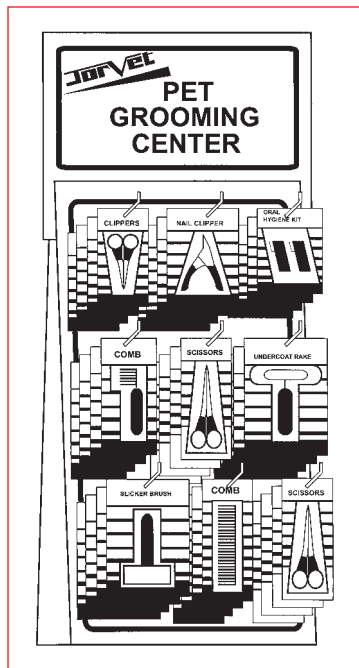

**Grooming Equipment.** The following equipment offers a broad range of instruments for most grooming needs. JorVet grooming equipment is attractively packaged for dispensing to clients. Most of the equipment is blister carded or header packed for in-clinic display or retail merchandising. Also the quality and economy is great for in-clinic use.



J0376

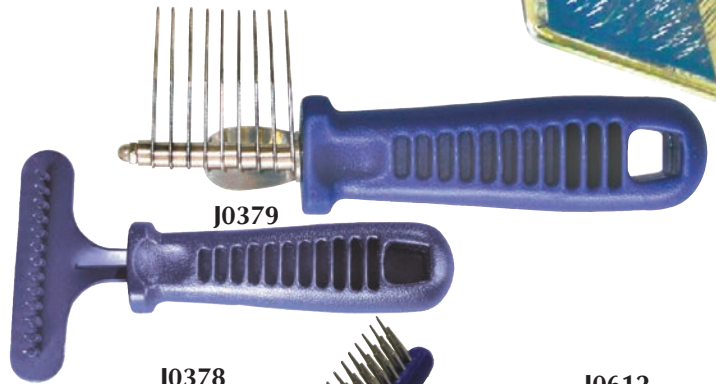

J0379

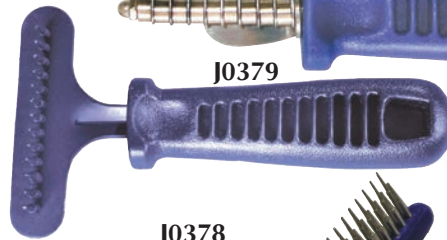

J0378



J0612

**J0376 Slicker Brush.** The slicker brush does a great job when removing a large amount of hair that a regular comb simply will not pick up and hold. Comes complete with small cleaning comb that removes hair from slicker. Stainless steel back and pins. Plastic handle. 5 1/4".

**J0379 Dematting Comb.** Sharp, serrated blades cut through tough mats quickly. Nylon handle. The best way to work through the most challenging cases.

**J0378 Undercoat Rake.** Designed to remove hair from the dense undercoat. One row of teeth in a T-shaped design. Attractive. Teflon-coated teeth with nylon handle.

**J0612 Undercoat Rake** with two rows of teeth. The extra row of teeth allows this rake to really get at removing clumps of dead and matted hair. Chrome-plated teeth avoid buildup of static in hair. Any dog with a heavy undercoat needs this rake. "T"-shaped non-slip blue handle. Packaged in attractive blister package.

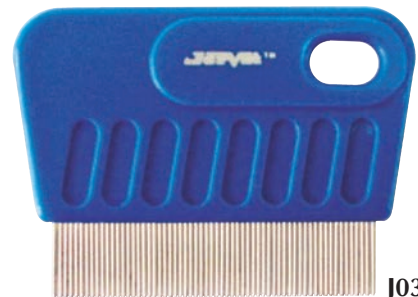

J0321a



J0321b

**J0321a Extra-Fine Comb** has 36 stainless steel teeth per inch. Comfortable nylon handle, convenient small hanging ring in handle. 12/pk.

**J0321b English Pattern Flea Comb.** 22 stainless steel teeth per inch. Blue nylon handle. 12/pk.



J0321c

**J0321c Disposable Flea Comb.** Double-sided. One side coarse, the other side fine. Great dispensing item to clients. 12/pk.

**J0321d Assorted Colored Flea Combs.** 72 combs in 4 neon colors in a convenient display jar.

**J0321e Colored Combs** only. 72/pk.



J0321d



**J0607**

**Shedding Blade.** Shedding blade with fine teeth on one side and coarse teeth on the reverse side. Leather strap. The shedding blade is very useful in removing dead and matted fur from thick and heavy undercoats. Packaged in poly bag with attractive header.

**J0607****J0604**

**Combination Grooming Comb and Brush.** This comb and brush has one side with metal pins for removing excess hair and tangles. There are over 120 wire teeth held by a flexible rubber base. The other side is nylon bristle comb that smooths out the hair coat. Attractive dark-varnished wood handle.

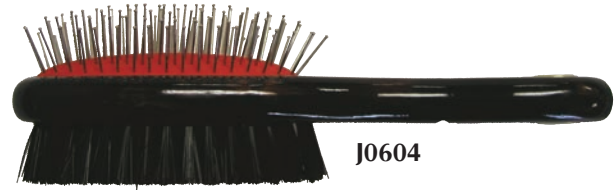
**J0604****J0603**

**Cat Grooming Glove.** Most cats enjoy being petted, however, grooming with a stiff comb is often stressful. These white grooming gloves have raised blue dots on both sides that catch loose hair while simply stroking the hair coat. The gloves are 60 percent polyester and 40 percent cotton. Washable. One size fits all. Packaged one pair per poly bag with an attractive header.

**J0603**



**J0381** **Auspex Avian Restrainer.** Extremely easy to use! Simply fold the flat restrainer to form a truncated cone shape, and rapidly place over the bird. Most birds pop out the smaller opening of the restrainer.

The restrainer is indispensable for various treatments, including examinations, administering oral medication or food, injections, working with legs, feet, or clipping nails.

**J0381a** **Restrainer.** Small. Canaries, budgies, cockatiels.

**J0381b** **Restrainer.** Medium. Conures, small Amazons.

**J0381c** **Restrainer.** Large. Amazons, African greys, and small cockatoos.

**J0381d** **Restrainer.** X-Large. Macaws and moluccan cockatoos.

**J0381s** **Restrainers.** Set of 4.



**J0381p** **Auspex Avian Positioner** is used to position an avian species for radiography and surgery. The Positioner is made of a piece of durable plexiglass board. There are two short slots and four longer slots machined through the board. Several pieces of strategically-placed Velcro hook-type fastener are permanently attached to the bottom of the board. Several straps of loop-type Velcro are supplied, which are utilized for restraining the bird's head and wings. Several pairs of the Velcro face straps, used to restrain the bird's legs, are also included.

The versatile Auspex Avian Positioner can be applied to most types of birds, from budgerigars to macaws. It is safe and relatively painless, since the bird is held using soft cloth-like straps, unlike the guillotine-type devices that hold the bird's neck down with a piece of hard plastic. It is hygienic, easy to clean and sterilize. The wing restraint is a novel feature, useful for radiography. The board has raised feet at the four corners to allow for placement of heating pads under it, when desired. 18"W x 18"L.



**J0391q** **Bird Leg Ring Cutter.** Aluminum and plastic leg rings frequently prevent venous return from the distal limb of small birds. Edema and necrosis quickly follows unless the ring is removed. Removal of the ring or band without fracturing is not easy without this special cutting tool. 4".

**Animal Feeding Needle.** Luerlock hub with stainless steel tube and nickel-plated silver ball on the end. Available in straight or curved. Specify type, gauge, and length when ordering.

<b>J0194s</b>	<b>Feeding Needle.</b> Straight.				
		<b>E</b>	<b>G</b>	<b>H</b>	
<b>J0194sa</b>	20g	2"L		4"L	
<b>J0194sb</b>	18g		3"L		
<b>J0194sc</b>	16g	2"L	3"L		
<b>J0194sd</b>	14g			4"L	

<b>J0194c</b>	<b>Feeding Needle.</b> Curved.				
		<b>E</b>	<b>G</b>	<b>H</b>	
<b>J0194ca</b>	20g	2"L	3"L		
<b>J0194cb</b>	18g	2"L	3"L		
<b>J0194cc</b>	16g	2"L	3"L	4"L	
<b>J0194cd</b>	14g	2"L	3"L	4"L	

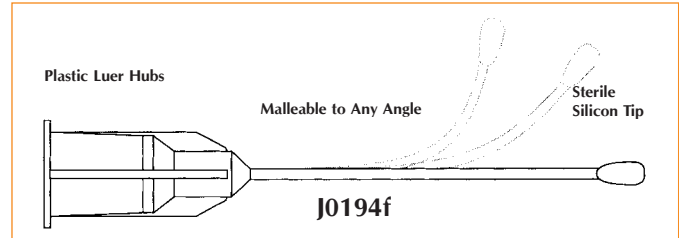
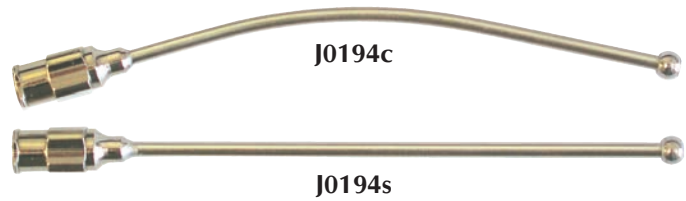

**Disposable Feeding Needle.** Nylon luer accepts standard syringe. Sterile. 5/bag

- Soft silicone rubber covered tips
- Malleable shaft to any angle
- Sterile
- Luer hub

<b>J0194fa</b>	<b>Feeding Needle.</b> 20g x 1 1/2".
<b>J0194fb</b>	<b>Feeding Needle.</b> 18g x 2".
<b>J0194fc</b>	<b>Feeding Needle.</b> 15g x 3".

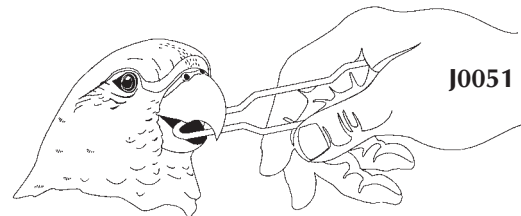

**Avian Oral Speculum.** The safe and effective way to examine the avian oral cavity; also aids in the administration of medication using the J-194 series JorVet feeding needles. Stainless steel.

<b>J0051x</b>	<b>Speculum.</b> Small. 4 3/4" x 1/4". (i.e., parakeets)
<b>J0051y</b>	<b>Speculum.</b> Medium. 4 3/4" x 3/8". (i.e., African grey parrots)
<b>J0051z</b>	<b>Speculum.</b> Large. 7 1/2" x 5/8". (i.e., full-size macaws)
<b>J0051s</b>	<b>Speculums.</b> Set of 3.

**Avian Plexiglass Collar.** Lightweight and rigid protective collar. Clear plexiglass. Uses two set screws (included).

<b>J0740</b>	<b>Collar.</b> Medium. 3.5cm dia.
<b>J0740L</b>	<b>Collar.</b> Large. 4.5cm dia.





J0392a



J0393a



J0397



J0399a



J0398b



J0398s



J0398a series



J0395



J0396a

*NOTE: Tray measurements reflect inside dimensions at shortest point. This is different from other manufacturers.*

**Instrument Tray** with recessed handle on lid. Cold sterilization.

**J0392a** Top: 10<sup>1</sup>/<sub>4</sub>" x 6<sup>3</sup>/<sub>4</sub>" x 2". Bottom: 9" x 5<sup>1</sup>/<sub>2</sub>" x 2".

**J0392b** Top: 12<sup>1</sup>/<sub>4</sub>" x 8" x 2". Bottom: 10<sup>1</sup>/<sub>2</sub>" x 6<sup>1</sup>/<sub>4</sub>" x 2".

**Instrument Tray** with strap handle on lid.

**J0393a** Top: 10<sup>1</sup>/<sub>4</sub>" x 6<sup>3</sup>/<sub>4</sub>" x 2". Bottom: 9" x 5<sup>1</sup>/<sub>2</sub>" x 2".

**J0393b** Top: 12" x 8<sup>1</sup>/<sub>4</sub>" x 2<sup>1</sup>/<sub>4</sub>". Bottom: 10<sup>1</sup>/<sub>2</sub>" x 6<sup>1</sup>/<sub>4</sub>" x 2".

**Instrument or Spay Pack Tray.** Below trays without lids.

**J0399a** Top: 10<sup>1</sup>/<sub>4</sub>" x 6<sup>3</sup>/<sub>4</sub>" x 2". Bottom: 9" x 5<sup>1</sup>/<sub>2</sub>" x 2".

**J0399b** Top: 12" x 7<sup>3</sup>/<sub>4</sub>" x 1<sup>15</sup>/<sub>16</sub>". Bottom: 10<sup>1</sup>/<sub>2</sub>" x 6<sup>1</sup>/<sub>4</sub>" x 2".

**J0394** **Sponge Bowl.** 3<sup>1</sup>/<sub>2</sub>" dia. x 2"D. (not pictured)

**J0396** **Forceps Jar.** 6<sup>1</sup>/<sub>2</sub>" x 2<sup>1</sup>/<sub>2</sub>". (not pictured)

**J0397** **Mayo Tray.**

Top: 13<sup>3</sup>/<sub>4</sub>" x 10" x 2<sup>2</sup>/<sub>3</sub>". Bottom: 11<sup>3</sup>/<sub>4</sub>" x 7<sup>1</sup>/<sub>2</sub>" x 2<sup>2</sup>/<sub>3</sub>".

**J0398b** **Stainless Steel Bucket.** 13-quart all-purpose bucket with handle. Type 304. 10<sup>1</sup>/<sub>4</sub>"H. Base-7<sup>7</sup>/<sub>8</sub>" dia., top-11<sup>1</sup>/<sub>2</sub>" dia.

**J0398s** **Round Straight-Sided Pail.** 12-quart stainless steel with handle. This pail takes up less storage space than conventional pails.

**J0398a** **Catheter and Instrument Tray** with cover and strap handle. 3"W x 8<sup>2</sup>/<sub>3</sub>"L x 1<sup>1</sup>/<sub>2</sub>"H. (22cm x ~7cm x 3.8cm).

**J0398** **Catheter and Instrument Tray** with cover.

Top: 3<sup>1</sup>/<sub>2</sub>"W x 12<sup>1</sup>/<sub>2</sub>"L x 1<sup>3</sup>/<sub>4</sub>"H.

(32.4cm x 9.3cm x 4.4cm).

Bottom: 12" x 3" x 1<sup>3</sup>/<sub>4</sub>".

**J0398c** **Catheter Tray.**

Top: 16" x 3" x 2<sup>1</sup>/<sub>2</sub>".

Bottom: 15<sup>3</sup>/<sub>4</sub>" x 2<sup>3</sup>/<sub>4</sub>" x 2".

**J0395a** **Dressing Jar.** 1-liter capacity.

5"H (10cm x 12.7cm) x 4" dia.

**J0395b** **Dressing Jar.** 2-liter capacity.

6<sup>1</sup>/<sub>4</sub>" (12.7cm x 15.9cm) x 5" dia.

**J0396a** **Thermometer Jar.** Stores glass thermometers.

Wide base to give greater stability and avoid jar from tipping over.

3<sup>1</sup>/<sub>4</sub>"H (3.4cm x 9cm) x 1<sup>1</sup>/<sub>3</sub>" dia.

**Stainless Steel Feeding and Water Bowls.** A wide range of sizes and styles offers many choices for your hospital patients. Stainless steel is rust and corrosion resistant, plus almost chew-proof. It is heavy-duty for everyday use. Also it cleans and disinfects easily. They will keep their bright shine and new look and they are dishwasher safe.

**Regular/Economy Bowl.** Standard shape. No sharp edges. 12-gauge thickness.

- J0802a** **Kitten/Puppy Bowl.** 1/2 pint (8 oz.)
- J0802b** **Bowl.** 1 pint (16 oz.)
- J0802c** **Bowl.** 1 quart (32 oz.)
- J0802d** **Bowl.** 2 quart (64 oz.)
- J0802e** **Bowl.** 2 1/2 quart (72 oz.)
- J0802f** **Bowl.** 3 quart (96 oz.)
- J0802g** **Bowl.** 5 quart (160 oz.)
- J0802h** **Bowl.** 7 1/2 quart (240 oz.)
- J0802j** **Bowl.** 10 quart (320 oz.)

**Premium/Heavy-Duty Bowl.** Standard shape with 9-gauge (up to 6-gauge on larger bowls) wall thickness.

- J0803a** **Bowl.** 1 pint (16 oz.)
- J0803b** **Bowl.** 1 quart (32 oz.)
- J0803c** **Bowl.** 2 quart (64 oz.)
- J0803d** **Bowl.** 3 quart (96 oz.)
- J0803e** **Bowl.** 4 quart (128 oz.)

**Non-Tip Bowl.** Heavy-duty bowl with wide diameter flared base and protective rubber cushion. This makes it difficult for animal to tip or knock over bowl. Less chance for messy water or food spills.

- J0804a** **Kitty/Puppy Bowl.** 1/2 pint (8 oz.)
- J0804b** **Bowl.** 1 pint (16 oz.)
- J0804c** **Bowl.** 1 quart (32 oz.)
- J0804d** **Bowl.** 2 quart (64 oz.)

**J0808** **Kick Bucket and Frame.** Heavy-duty stainless steel frame. Rubber ball bearing 2" casters. 360° bumper on frame. 13-quart stainless steel bucket (J-398b). 14 1/2" dia. x 12"H with bucket.

**J0808f** **Frame** only.

**Stainless Steel Pail with Handle.**

- J0805a** **Pail.** 2 quart (64 oz.)
- J0805b** **Pail.** 4 quart (128 oz.)
- J0805c** **Pail.** 6 quart (192 oz.)
- J0805d** **Pail.** 9 quart (288 oz.)
- J0805e** **Pail.** 13 quart (416 oz.)

**J0807** **Single Post Mayo Stand.** U-shaped heavy chrome base, 18" x 22". Two ball bearing rubber casters. Removable stainless steel tray. Adjustable in height 31"–50".

**J0807d** **Double Post Mayo Stand.** Heavier rectangle base, 21" x 20". Two ball bearing rubber casters. Removable stainless steel tray. Adjustable height 34"–54".

**J0807t** **Stainless Steel Replacement Tray.** 19" x 12 1/2" x 3/4".

**J0807m** **Mobile Instrument Stand.** Stable 5-leg aluminum base, 24" diameter. Dual wheel casters. Removable stainless steel tray. Adjustable height 31"–50".



J0802 & J0803 Series



J0804 Series



J0805 Series



J0808f



J0808



J0807

J0807m

J0807d

For years, Jorgensen Labs has provided the highest quality and specialized instruments needed for the veterinary profession. Now JorVet introduces a premium line of **Ultrasonic Cleaners** and **Cleaning Solutions** that keep your instruments spotless for a longer lasting performance.

**What is ultrasonic cleaning and how does it work?**

High frequency sound waves are used to produce more than 40,000 alternating high and low pressures per second. As these waves travel through a specially formulated cleaning solution, millions of microscopic bubbles form and violently implode. This process, known as cavitation, creates a scrubbing action capable of cleaning up to 16 times more efficiently than hand scrubbing. In minutes, all body fluids and foreign particles are removed, even from the tightest grooves, cracks and interior surfaces of the instrument being cleaned.

JorVet ultrasonic cleaning systems represent the most advanced technology in ultrasonic cleaning available today.

Features:

- Heavy-duty transducer is 25 percent heavier, providing greater power and better dissolution in the tank.
- Extended limited warranty of 2½ years.
- *Basket recommended.*



Model	Tank Capacity	Internal Tank Dimension	Overall Length
<b>J0382a</b> <b>Standard.</b>	3 <sup>3</sup> / <sub>8</sub> quarts	5 <sup>3</sup> / <sub>8</sub> "W x 9 <sup>3</sup> / <sub>8</sub> "L x 4"H	6 <sup>3</sup> / <sub>8</sub> "W x 10 <sup>3</sup> / <sub>8</sub> "L x 8"H
<b>J0382ab</b> <b>Basket.</b> (optional)		5"W x 8 <sup>7</sup> / <sub>8</sub> "L x 3"H	
<b>J0382b</b> <b>Deluxe.</b>	1½ gallon	6"W x 11 <sup>3</sup> / <sub>4</sub> "L x 6"H	6 <sup>7</sup> / <sub>8</sub> "W x 12 <sup>5</sup> / <sub>8</sub> "L x 9 <sup>3</sup> / <sub>4</sub> "H
<b>J0382bb</b> <b>Basket.</b> (optional)		5 <sup>1</sup> / <sub>8</sub> "W x 11 <sup>1</sup> / <sub>8</sub> "L x 4 <sup>1</sup> / <sub>2</sub> "H	

**JorVet Concentrated Cleaning Solution** is non-ammoniated. This concentrated solution is designed to dilute one part concentrate to ten parts water. It is specially formulated to provide a mild yet effective solution for cleaning instruments. Properly used, it will easily remove blood and other body fluids for longer instrument life.

**J0382g** **JorVet Ultrasonic Cleaning Solution.** Gallon.





**JorVet Veterinary Surgical Drape.**

- Quality surgical drapes of 50 percent cotton, 50 percent polyester, made of surgical-grade textiles
- Fenestrated drapes feature a moisture proof barrier near the fenestration that repels body fluids so that they do not soak through and draw up contaminants from beneath the drape into the surgical field
- Durable quality, may be safely washed and autoclaved frequently



**J0256 Series**

- J0256a Surgical Drape.** 20" x 28". 4" x 3/4" opening.
- J0256b Surgical Drape.** 24" x 32". 2" x 1" opening.
- J0256c Surgical Drape.** 30" x 36". 7" x 1 1/4" opening.
- J0256d Surgical Drape.** 40" x 40". 9" x 1" opening.
- J0256e Surgical Drape.** 40" x 40". 4" x 3/4" opening.
- J0256f Surgical Drape.** 20" x 20". 2" circular opening. (for ophthalmic surgery)
- \*J0256g Surgical Drape.** 20" x 24". 6" x 9" opening.
- \*J0256h Surgical Drape.** 24" x 30". 9" x 12" opening.
- J0256j Surgical Drape.** 27" x 27". Nonfenestrated, for draping areas of the animal, not close to surgery field

*\* Leg Drape. While animal is in lateral recumbency, drape opening slides up into inguinal area. Top half of drape folds over leg, while bottom half covers other leg.*

*NOTE: Custom sizes available.*



**J0257 Series**

**Surgical Pack Wrapper.** Double-layered reusable wrappers.

- J0257a Wrapper.** 18" x 18".
- J0257b Wrapper.** 27" x 27".
- J0257c Wrapper.** 10" x 12". Surgeon's glove wrapper. Single-ply.

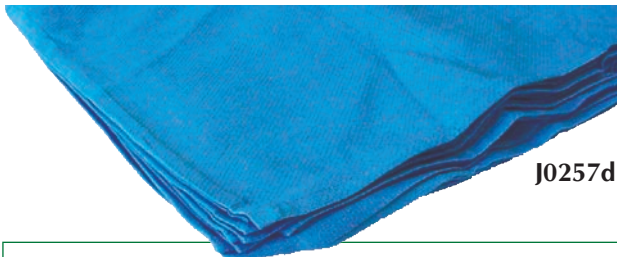

**J0257d**

- J0257d Surgery Towels.** Huck-style. General purpose surgery towels. 100 percent cotton. Highly absorbent. Light blue. 17" x 33". 12/pkg.

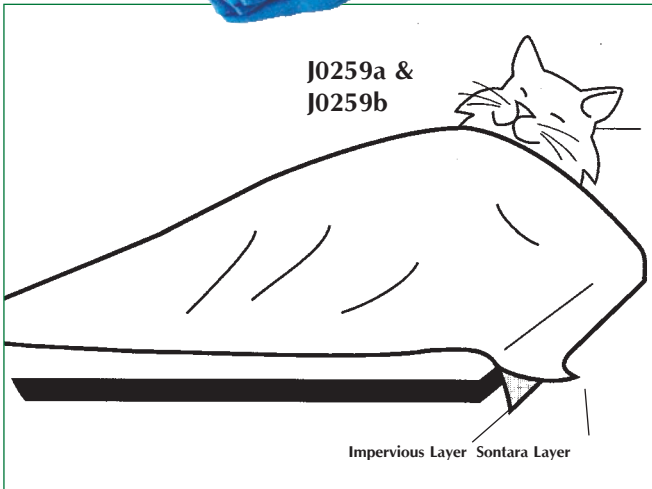

**Impervious Drape Material.** The base material is Sontara laminated with polyethylene film making it completely impervious. This drape has the highest tear strength of any drape fabric. It can be readily fenestrated at the time of surgery without the need for reinforcement. Fanfolded in easy opening header packer. Once you try this drape you will want it for all your extended procedures.

- Sterile individual wrap
- Covers entire patient

- J0259a Draper.** 40" x 42". Small dog and cat. 5/pkg.
- J0259b Draper.** 60" x 80". Canine size. 5/pkg.

**Avian/Exotic Adhesive Drape.** The preferred drape for smaller animals where visualizing your anatomic landmarks is critical. Large enough for cats and small dogs.

- Clear plastic material
- 5" x 5" square area of adhesive to adhere to animal
- Individually wrapped in sterile, easy open header pack

**J0259x Adhesive Drape.** 44" x 44". 5/pkg.  
**J0259xs Adhesive Drape.** 24" x 24". 5/pkg.

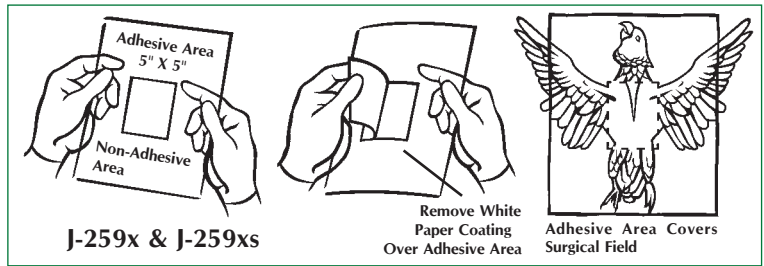

**Adhesive Drape** impregnated with povidine (antimicrobial). There is no fenestration. Can also be used post op for wound protection. Light amber color. Sterile.

**J0259q Drape.** 34" x 34", 24" x 34" adhesive area.  
**J0259r Drape.** 24" x 14", 14" x 14" adhesive area.  
**J0259s Drape.** 34" x 18", 24" x 18" adhesive area.

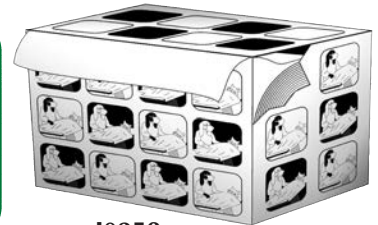

J0258s

**Disposable Surgical Drape.** Jorvet offers two types of disposable surgical drapes offering different styles of packaging. Both can be cut to any length and autoclaved repeatedly.

**J0258 Sontara Disposable Surgical Drape.** The original Jorvet drape with the blue, rich cloth-like feel of Sontara fabric packaged in a fan-folded box. 38"W x 100 yds in a blue and red box. Variance may be 36" to 40".

**J0258Q Oversize Pre-cut Sontara Drape.** Large oversized drape that is great for equine or large animal use. Folded to open first in the long dimension. 77" wide x 104" long. Sterile.

**J0258w Extra-Wide Sontara Drape.** On dispensing roll. 60" x 100 yds. 22lbs. (not pictured)



J0258



**Surgery Sterilization Pack Wrap (CSR).** These non-woven, soft but tough surgical wraps are useful for wrapping surgery packs during sterilization and storage. They can also be used for actual surgery drapes in pre-cut sizing. The green Sontara fabric is very durable but economical. It withstands steam sterilization for a superior barrier against air and water borne bacteria.

**J0258a Wrap.** 18" x 18". 50/pk.  
**J0258b Wrap.** 24" x 24". 50/pk.  
**J0258c Wrap.** 30" x 30". 50/pk.  
**J0258d Wrap.** 36" x 36". 50/pk.  
**J0258e Wrap.** 45" x 45". 50/pk.



J0258 a-e

**Clear Adhesive Surgical Drape/Film with povidine.** The majority of human surgeries use clear adhesive drape over the incision site. The rest of the patient is draped with standard non-woven disposable drape material. The clear adhesive drape offers several advantages:

- 1 Transparency—the film is ultra thin and highly transparent, which gives clear observation to the surgical field for locating anatomical landmarks.
  - 2 Antibacterial—impregnated with povidine iodine giving the drape a slight orange tint. Very effective against most skin pathogens.
  - 3 Fluid and pathogen resistance—sterile barrier prevents fluids or pathogens right up to the edge of the incision.
  - 4 Permeable—allows the skin to breathe and vapor to pass.
  - 5 High elasticity—follows natural contours for reliable gap-free adherence.
  - 6 Low sensitivity—no irritation to skin or wound
  - 7 Moderate viscosity—no injury to skin when removing the dressing.
- Range of sizes, packaged sterile in sealed pouch

**J01086a** 14cm x 20cm (6" x 8") 20 pieces/box  
**J01086b** 20cm x 30cm (8" x 12") 20 pieces/box  
**J01086c** 30cm x 45cm (12" x 18") 20 pieces/box  
**J01086d** 45cm x 60cm (18" x 24") 10 pieces/box

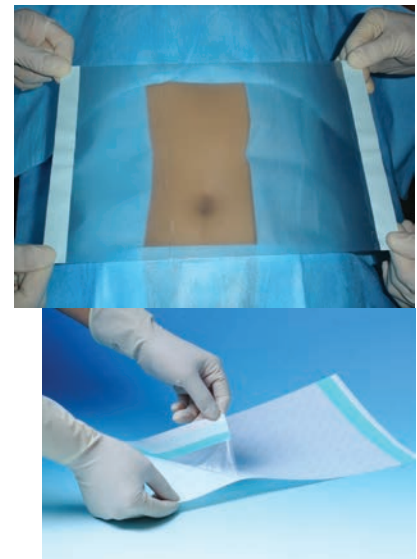

**Drape Material Components:** JorVet has expanded the range of drape offering to include more types of materials in various sizes:

**Sontara:** popular DuPont product that has a soft cloth like feel. It is fluid repellent, but fluids will strike through with extended exposure. *Autoclavable*. Sontara is available coated with a clear poly film which makes it impervious. However, the impervious material cannot be autoclaved and is provided sterile.



**ACT:** DuPont's newer material (Advanced Composite Technology) is gaining popularity for drapes and gowns. It has an embossed pattern and is comparable to SMS material. The plain material *can be autoclaved* but the impervious drape must be provided in sterilized pouches.

**Towel drapes:** aka four corner drapes. Many surgeons prefer laying drape on four sides of an incision. Often small towel drapes are laid out then covered with a larger drape. The larger towel drapes are used without a covering drape.

**Plain Sontara**, folded to open to long dimension first  
**J1060** B 44" x 55" sterile, tyvek pouch  
 C 55" x 77" non-sterile  
 D 55" x 77" sterile, tyvek pouch

**Coated Sontara**, folded to open to long dimension first  
**J0259** A 40" x 42" sterile, tyvek pouch  
**J0259** B 60" x 80" sterile, tyvek pouch

**ACT material**, plain opens to long dimension first  
**J1062** A 44" x 55" non-sterile  
 B 44" x 55" sterile, tyvek pouch  
 F 77" x 104" sterile, tyvek pouch

**ACT material**, coated opens to long dimension first  
**J1063** A 40" x 42" sterile, tyvek pouch  
 B 60" x 80" sterile, tyvek pouch

**Towel drapes**, plain Sontara  
**J1064** C 36" x 36" non-sterile, 4/pk

**Towel drapes**, plain ACT material  
**J1065** A 22" x 30" non-sterile, 4/pk  
 D 36" x 36" sterile, 4/pk. tyvek pouch





**Equivet disposable surgical line.** JorVet introduces a specialized line of surgical disposables for the surgeon working in an equine clinic or hospital. All surgical sets have been produced so they include all drapes and accessories needed for the particular procedure. The sets are manufactured with high quality and are very affordable. Our Colic Gowns offer an excellent protection and meet all specifications for quality and are very attractively priced.



**J1280 Equivet Laparoscopy Set, sterile.**

- 1 x wrapping table cover reinforced 160 x 200 cm
- 1 x mayo cover 80 x 145 cm
- 4 x drapes with adhesive tape 10 x 50 cm
- 2 x towels 30 x 40 cm
- 2 x SMS surgical gowns XL
- 1 x incise drape 45 x 42 cm
- 1 x drape 250 x 500 cm with incision area 10 x 35 cm and two fluid collection pouches

**J1280a Equivet Laparotomy Set, sterile.**

- 1 x wrapping table cover reinforced 160 x 200 cm
- 1 x table cover 160 x 200 cm
- 2 x leggings 3 ply 75 x 120 cm
- 1 x drape with adhesive tape 10 x 50 cm
- 1 x drape 260 x 370 cm incision area 10 x 60 cm, fluid collection pouch 95 x 100 cm with U split 30 x 70 cm
- 2 x U split 15 x 85 cm



**J1280b Equivet Arthroscopy Set, sterile.**

- 1 x wrapping table cover reinforced 160 x 200 cm
- 1 x drape with adhesive tape 10 x 50 cm
- 2 x towels 30 x 40 cm
- 2 x SMS surgical gowns XL
- 1 x stockinette 22 x 100 cm
- 1 x drape 250 x 500 cm with two rectangular fenestration 10 x 32 cm covered with leastic film and reinforcement



**J1280c Equivet Extremity Set, sterile.**

- 1 x wrapping table cover reinforced 160 x 200 cm
- 1 x drape 200 x 320 cm with elastic fenestration 6 cm, reinforcement and tube holders

**J1280d Equivet Bilateral Extremity Set, sterile.**

- 1 x wrapping table cover reinforced 160 x 200 cm
- 1 x drape 200 x 320 cm with two elastic fenestration 6 cm, reinforcement



**J1281 Equivet Colic Gown, sterile.**

Reinforced total outer protection impervious PE/Non woven on the front and on the sleeves. Non woven hydrophobic SMS on the back 4 x belts and 2 x towels.



<b>J1281</b>	<b>M</b>	145 cm width	120 cm height
<b>J1281a</b>	<b>L</b>	150 cm width	130 cm height
<b>J1281b</b>	<b>XL</b>	160 cm width	140 cm height
<b>J1281c</b>	<b>XXL</b>	170 cm width	150 cm height

The ECG is one of the most under utilized diagnostic parameters in veterinary medicine. An ECG is an absolute necessity for proper cardiac diagnostics. The Jorvet Single Channel ECG and monitor offers what veterinarians need at a very reasonable price. The all-important lead II rhythm strip can be run for screening purposes; and if further evaluation is deemed necessary, all 6 common leads can be run for more thorough diagnostics.

**Features and Benefits:**

- One touch keypad buttons allow for easy set up and operation
- Large screen is well lit and easy to read
- Single channel displays and prints one lead at a time
- Features both MANUAL and AUTO modes
- Dimensions are 12"L x 8<sup>7</sup>/<sub>8</sub>"W x 2<sup>5</sup>/<sub>8</sub>"H
- Weighs just 6.25 lbs
- Operates on either AC or 12 volt NiMH rechargeable battery
- Patient comfortable electrode clips
- Built in paper printer
- Supports patient monitoring via onscreen tracing, i.e., lead II
- Supports diagnostic evaluation via the printed tracing
- 3 year warranty on the ECG unit, 1 year on battery and leads

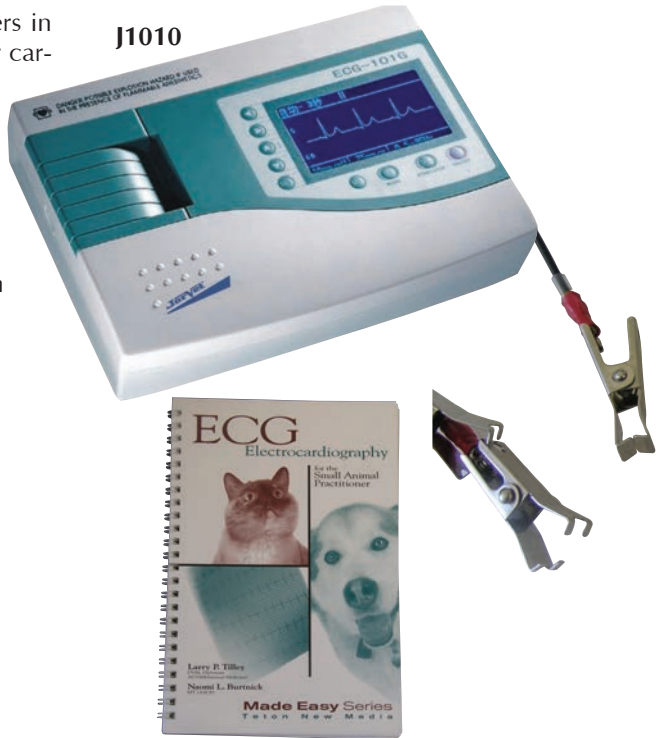

**J1010 ECG unit.**

**J1010d3 ECG Paper.** roll

**J0166m Vet Alarm Respiratory Monitor.** This respiratory monitor is a simple yet reliable indicator of apnea. The sensor is placed in the breath pathway and detects each breath. If a breath does not take place in a selected time interval an alarm will sound. A flashing liquid crystal screen shows the last time a breath was detected. 2" x 5" x 5".

- Small. 1<sup>1</sup>/<sub>2</sub> lbs.
- Rechargeable battery
- Mounting bracket

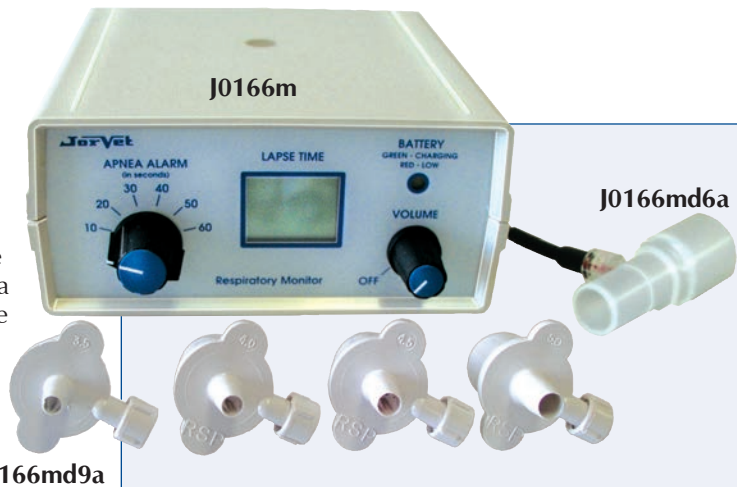

**J0166md6a Double end connector, 15mm**  
**J0166md9a Endo tube connector.** Pack (4).

**J0166rm Breathe Safe Respiratory Monitor.** This tiny—smaller than a cigarette pack—monitor makes a great apnea alert monitor. The small microprocessor beeps with every breath with a very high sensitivity. 1<sup>1</sup>/<sub>2</sub>"W x 2<sup>1</sup>/<sub>4</sub>"L x 1<sup>1</sup>/<sub>2</sub>"D. 3oz.

- Easy to use: just connect between endotracheal tube and anesthesia circuit
- No adjustments: a sophisticated algorithm recognizes and indicates every breath with a beep, working from a 1 lb. kitten to a 200 lb. St. Bernard.
- Apnea alert; a distinctive alert sounds if patient fails to breathe for 45 seconds
- Auto shut-off
- A high density long-life lithium battery provides years of service
- One-year warranty

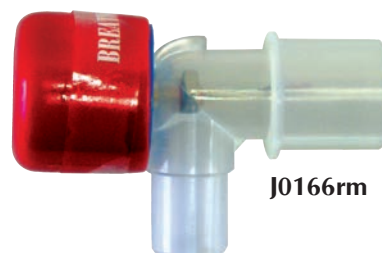
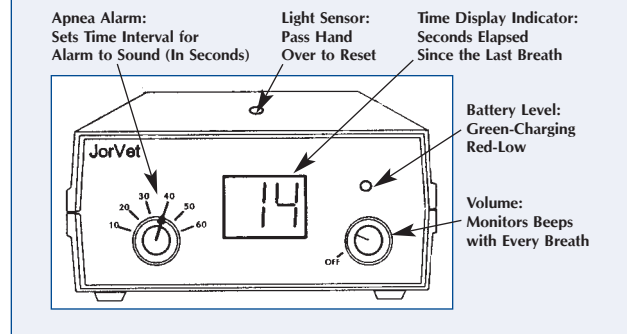



**Doppler Ultrasonic Blood Flow Monitor** non-invasive blood pressure monitoring. Hypertension (high blood pressure) is often overlooked during diagnosis, treatment, and routine physical exams in small animals. In addition, many hypotensive (low blood pressure) patients, such as those suffering from shock, benefit greatly from Doppler measurement of blood pressure when knowing the pressure can mean effective and timely treatment.

Combining Doppler with an appropriate size “cuff” for small animals, provides the veterinarian with the same, non-invasive method for testing blood pressure as is available in human medicine. Limited one-year warranty. Cuffs are excepted.

A small probe is placed over a peripheral artery (e.g., digital or coccygeal). An ultrasonic crystal in the probe transmits pulse wave sounds back to the amplifier. The pressure cuff is then placed proximal to the probe. The cuff is inflated until the pulse sounds are no longer audible. The cuff is slowly deflated, using the manometer, until pulse sounds are audible once more, at which point the manometer displays a numeric value of the animal’s systolic pressure.

**Features:**

- Lightweight, hand-held unit
- High-quality, veterinary-specific sphygmomanometer
- Comes with two cuffs (2.5cm and 5.0cm)
- Runs on 9-volt battery (included)
- Headset included
- Complete with carrying case
- Limited one year warranty on box and transducer only

- J0563** Complete Unit with small, flat probe.
- J0563d3** Sphygmomanometer only. 90-day warranty.
- J0563d4** Cuff only. 2.5cm.
- J0563d5** Cuff only. 5.0cm.
- J0563d6** Cuff only. 7.5cm.
- J0563d7** Cuff only. 10.0cm.

**J0563d4a** Cuff only. 1.9cm.

**Disposable Blood Pressure Cuff.**

These cuffs are made from a soft white vinyl. They feature a Velcro closure and will fit all models of blood pressure measurement systems. A single tube. Made in the USA, and inexpensive. White. 5/pk. Female luerlock.

Proper Size is 40 percent of the circumference of the limb when the cuff is being applied. These sizes should cover just about all small animals. Cuff size ranges in centimeters.

- J0563q** Cuff. 3.5cm W. 8–15 cm L.
- J0563r** Cuff. 3.0cm W. 7–13 cm L.
- J0563s** Cuff. 2.5cm W. 6–11 cm L.
- J0563t** Cuff. 2.0cm W. 4–8 cm L.
- J0563x** Cuff. 1.5cm W. 3–6 cm L.
- J0563v** Set of Cuffs. One of each size.

Other connectors/adapters also available.



**J0563 Cuff Series**



**J0484m Deluxe Bovie Electro Surgery Unit.** This is a top-of-the-line Electro surgical unit made by the original Bovie Company. They first invented the Electro surgical unit in the 1920s. The complete table top unit is fitted with veterinary specific equipment.

Five modes: cutting, cutting/coagulation, coagulation, fulguration, bipolar.

- User has option of handpiece finger switch or foot control
- Rotary dial operates power; shown in 1 watt increments via LED readout
- Reusable body pad (ground plate)
- Built-in bipolar (*requires optional foot pedal*)
- Five 3/32" electrodes; interchangeable with other same size brands
- 10<sup>1</sup>/<sub>4</sub>"W x 5<sup>1</sup>/<sub>2</sub>"H x 10"D, 14 lbs.
- U.L. approved

**Accessories Included:**

- 1 x **J0484md1c** Autoclavable Handpiece
- 2 x **J0484md1a** Disposable Handpiece
- 1 x **J0484d3** Ground plate + cord
- 2 x **J0484ad4** Short straight needle electrode (A0835)
- 1 x **J0484a5** Ball electrode (ES20R)
- 2 x **J0484ad5** Blade electrode (ES01R)



**J0484m**

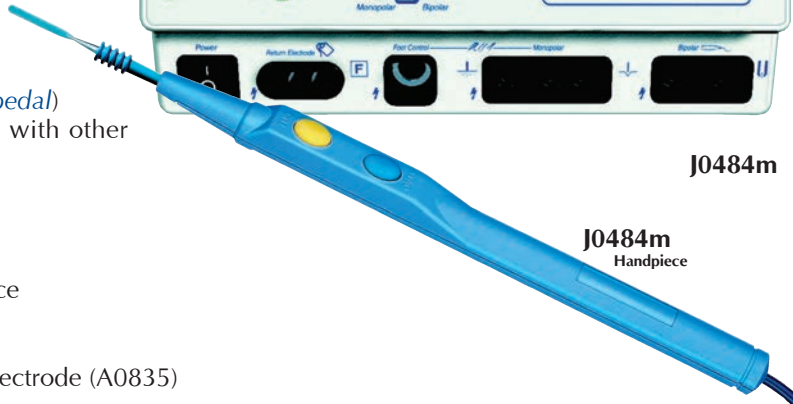

**J0484m**  
Handpiece

*NOTE: Bipolar forceps and cord sold separately.  
Must purchase foot pedal switch for bipolar.  
**J0484md9** Foot pedal for bipolar applications.*

**J0470 JorVet Electrosurgical Unit.** The most affordable unit available for today's veterinary surgeon. With more than enough power for any procedure.

**Features:**

- 3 operating modes at the turn of a dial
- Fully filtered: smooth cutting
- Fully rectified: cutting & coagulation
- Partially rectified: Coagulation: larger bleeders
- 10 different power settings
- Wide selection of electrodes included
- Includes ground plate

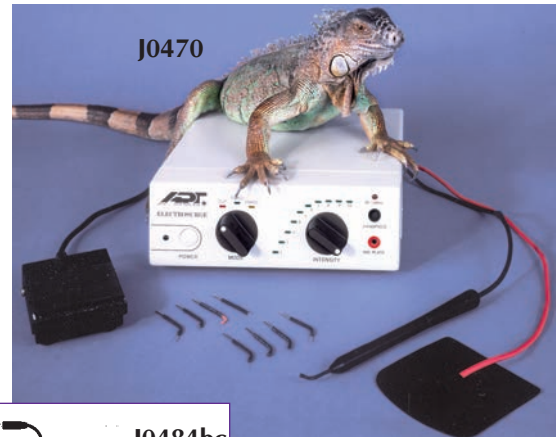

**J0470**

**J0470b Bipolar Converter.** Plugs into front of **J0470** unit to convert to bipolar mode.

Bipolar mode of coagulation is especially useful in small species such as birds. It allows for a more precise and controlled coagulation, including in wet field.



**J0484bc**

**J0470b**

*Recommended additions for exotics*

**J0484bc Bipolar Cord.**

**J0470d1 Hand Piece and Cord.**

**J0470d2 Ground Plate.**

**J0470d3 Set of 7 Electrodes.**

**J0470dt1 Diamond Loop.**

**J0470dt2 Large Loop.**

**J0470dt3 Small Loop.**

**J0470dt4 Heavy Wire.**

**J0470dt5 Fine Wire.**

**J0470dt7 Small Oval Loop.**

**J0470dt9 Ball Electrode**

**J0470d3 Set of 7 Electrodes**



**J0470d3**

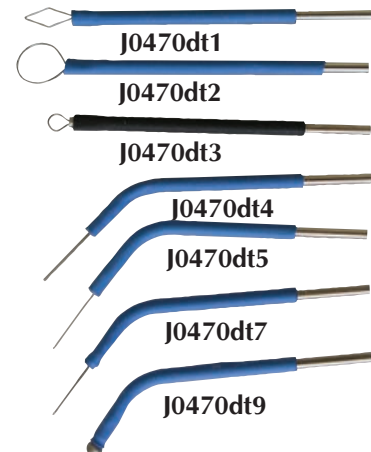

**J0470dt1**

**J0470dt2**

**J0470dt3**

**J0470dt4**

**J0470dt5**

**J0470dt7**

**J0470dt9**

The wide range of **JorVet Electrodes** come in four different types.

- **$3/32$ " Autoclavable.** Use only with **J0484m**
- **BiPolar.** Autoclavable. Use with **J0484m** and **J0470** (needs bipolar convertor)
- **$3/32$ " Disposable.** Raised grip for easy removal. Use only with **J0484m** unit
- **$1/16$ " Autoclavable.** Use only with **J0470** unit



**Reusable Electrode.** Autoclavable.  $3/32$ ".

**J0484a1 Angled Fine Needle.**

**J0484a2 Angled.**

**J0484a3 Angled Sharp.**

**J0484a4 Angled Ball.**

**J0484a5 Straight Ball.**

**J0484a6 Straight Needle.**

**J0484a7 Long Straight Ball.**

**J0484a8 Long Straight Needle.**

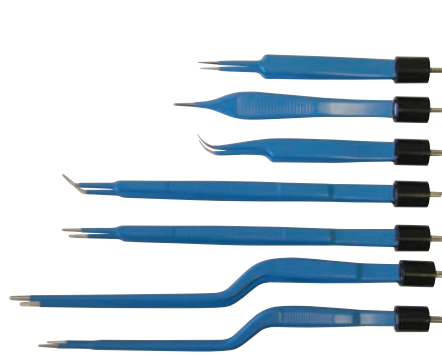

**Reusable Bipolar Forceps.** Autoclavable.

**J0484b1 Fine Forceps.** 5".

**J0484b2 Medium Forceps.**  $5\frac{1}{2}$ ".

**J0484b3 Curved Fine Forceps.** 5".

**J0484b4 Curved Fine Forceps.** 7".

**J0484b5 Straight Fine Forceps.** 7".

**J0484b6 Bayonet Medium Forceps.**  $7\frac{1}{2}$ ".

**J0484b7 Bayonet Fine Forceps.**  $7\frac{1}{2}$ ".

**J0484bc Bipolar Cord for J-484m.**

**J0484md9 Foot Pedal for Bipolar.**



**Disposable Electrode.**  $3/32$ ".

**J0484ad4 Standard Needle.** 25/box.

**J0484ad5 Standard Blade.** 50/box.



**Reusable Loop Electrode.** Great for removing skin tumors.  $3/32$ ".

**J0484ad2 Loop.**  $3/8$ " dia.

**J0484ad3 Loop.**  $1/2$ " dia.



**J-484a**

**Triangle Electrode.** Reusable.  $3/32$ ".

**J0484a10 Electrode.**  $1/4$ ".

**Electrode Styles.** Autoclavable.  $1/16$ ".

*NOTE: DO NOT store in liquids.*

**J0484md6 Reducer adaptor.** This allows smaller electrodes ( $1/16$ ") to be used with Bovie handpieces ( $3/32$ "). Especially useful for smaller Ellman electrodes.

**Portable Cordless Cautery.** Small portable cautery, excellent for hemostasis. Detachable 1/2" fine tips. Cordless and lightweight.

- J0313a** **Cautery High Temp 2200°F.** Uses two "AA" batteries. (included)
- J0313b** **Cautery Low Temp 1100°F.** Low temp minimizes damage to surrounding tissues. Uses single AA battery. (included)

**Convenient Cautery Kit.** Comes with a handpiece that uses two AA batteries (included), and the below four replaceable cautery tips:

- 1/2" fine electrode, useful for hemostasis control
- 1/2" loop electrode for wide use, such as small skin tumors
- 2" fine electrode for difficult areas
- 2" loop electrode

These tips deliver high temperatures up to 2200° F. All tips fit easily into the handpiece.

- J0313** **Convenient Cautery Kit.**
- J0313w** **Replacement Cautery Tip.** Fine. 1/2".
- J0313x** **Replacement Cautery Tip Loop.** 1/2".
- J0313y** **Replacement Cautery Tip.** Fine. 2".
- J0313z** **Replacement Cautery Tip Loop.** 2".
- J0313d1** **Sterile Sleeves.** 10/pk.



**Thermal Cautery Unit.** The TCU provides all the cautery power necessary for treating the numerous minor surgical conditions seen by veterinarians in everyday practice. This unit is ideal for dermatological and ophthalmologic applications, or any procedure that requires accurate hemostasis.

The autoclavable hand piece with 6' cord accepts an assortment of reusable thermal cautery electrodes, allowing maximum flexibility to perform varied procedures.

Benefits include:

- No aberrant radio frequency currents to cause unintended tissue damage or shocking.
- Unlike disposable battery powered cauteries, the TCU maintains the desired temperature during tissue contact and does not rapidly diminish.
- 110V AC plug-in
- 5" (12.7cm) W x 8" (20.3cm) H x 5" (12.7cm) D.
- 4 lbs. (1.8kg)
- One-year warranty

**J0846** **Thermal Cautery Unit.** Includes loop tip (**J-846a**), fine tip (**J-846e**), and angled-loop tip (**J-846c**) cautery electrodes.

**J0846d1** **Handpiece.** Autoclavable.

**Platinum General Purpose Cautery Electrode.** Non-sterile. May be autoclaved.

- J0846a** **Cautery Electrode.** Loop Tip.
- J0846b** **Cautery Electrode.** Fine Flat Tip.
- J0846c** **Cautery Electrode.** Angled Loop Tip.
- J0846d** **Cautery Electrode.** Ball Point Tip.
- J0846e** **Cautery Electrode.** Fine Tip.





**Sterilizing Tray.** These autoclavable trays use a silicone pegged mat that allows the instruments to be placed in any configuration the surgeon desires. The instruments are easily located in the tray. The whole tray is wrapped and then autoclaved. **Instruments not included.**

- J0041t** **Autoclavable Double-Layer Instrument Tray.** 10" x 6".
- J0664t** **Tray.** Small. 6 1/2" x 4" x 1 1/4".
- J0665** **Tray.** Large. Holds a spay surgery pack. 15" x 10" x 1". (not pictured)
- J0665L** **Tray.** X-Large. Two layers. 15" x 10" x 1 3/4". (not pictured)
- J0666** **Rigid Endoscope Tray.** Two silicone bars hold scope in safe carrying/storage case. 16" x 2 1/2" x 1 1/2".
- J0667** **Knife Tray.** This autoclavable tray holds small knives like teat or tendon knives via two silicon bars. 6" x 2 1/2" x 3/4".

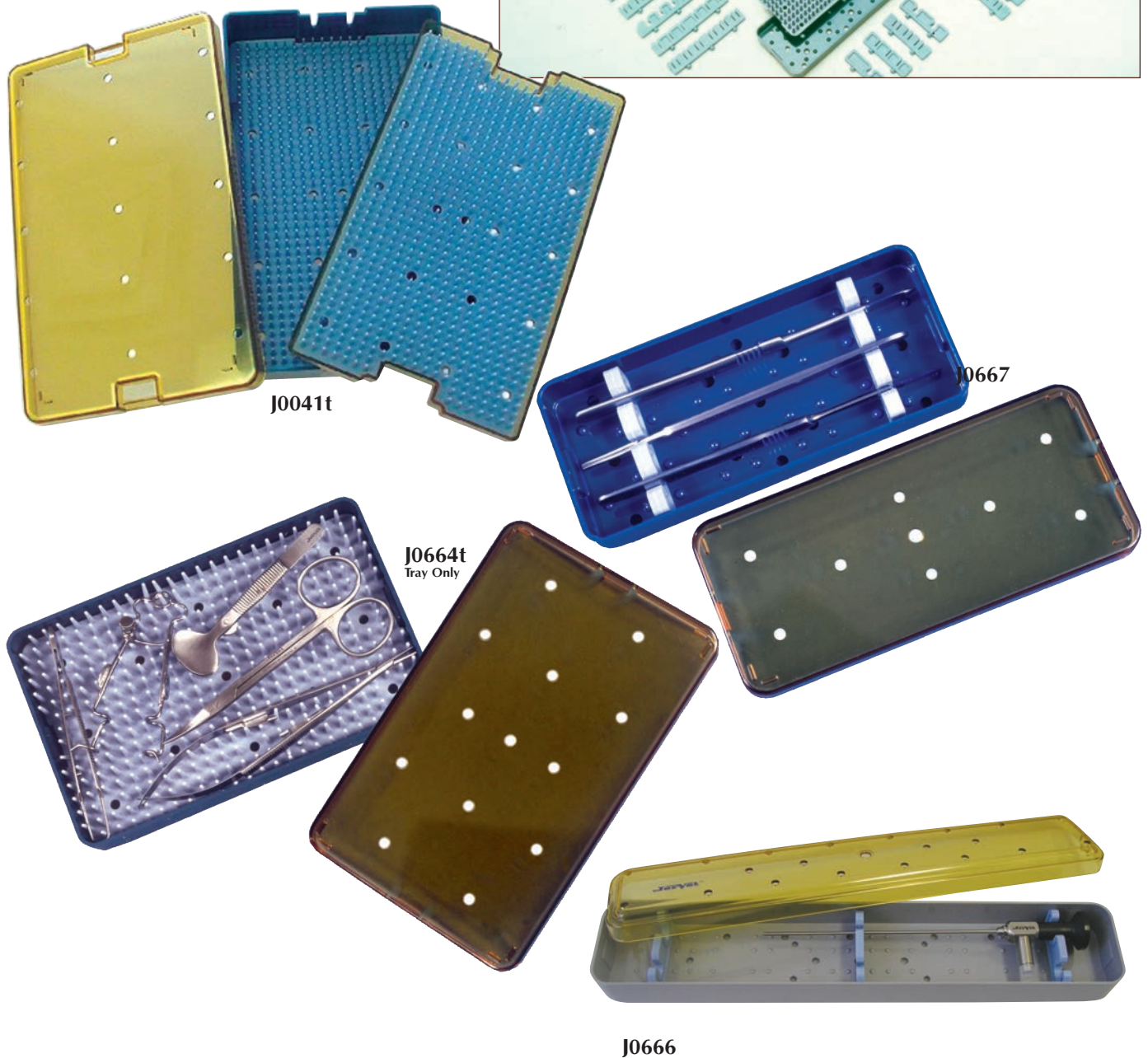

**Cold Sterilization Tray.** Three piece soaking and sterilization set is ideal for cold soaking instruments. The perforated tray can be lifted out of any solution.

- Stainless steel latches seal the tray
- Can be autoclaved up to 300° F
- Red fiberglass reinforced plastic

**J0369** Tray. 6"W x 9<sup>3</sup>/<sub>4</sub>"L x 4<sup>1</sup>/<sub>2</sub>"H.  
**J0369L** Tray. 11"W x 17"L x 6"H.

*NOTE: Not water tight.*



**J0366** **Endoscope Soak/Storage Tray.** Most rigid endoscopes should be immersed in sterilization solution for 15 minutes before use. This tray consists of a perforated soaking basket that holds the endoscope and is lifted out after proper soaking. Made of fiberglass reinforced plastic that can be autoclaved up to 350° F. Cover included.

Tray: 24" x 8" x 5<sup>7</sup>/<sub>8</sub>".  
 Basket: 22<sup>1</sup>/<sub>2</sub>" x 6<sup>3</sup>/<sub>8</sub>" x 4<sup>3</sup>/<sub>4</sub>".  
 Cover: 24" x 8" x 1<sup>1</sup>/<sub>2</sub>".

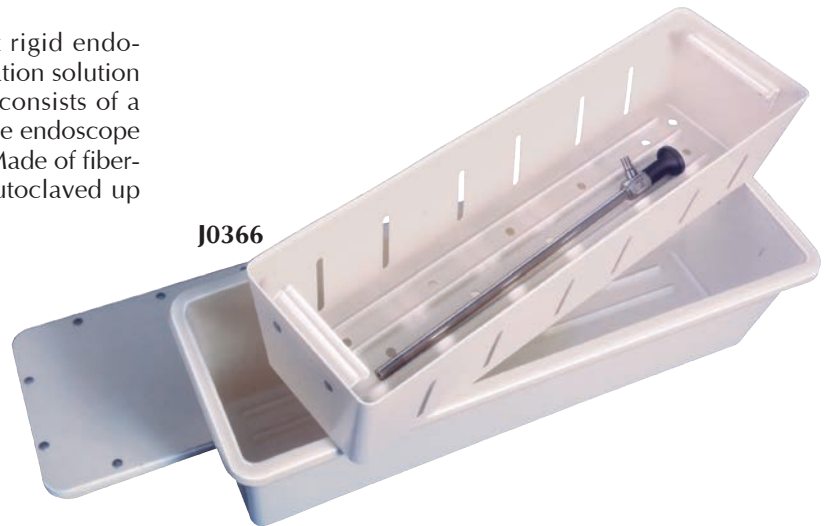

**J0367m Narcotic Cabinet.** A narcotic cabinet keeps scheduled drugs safe under lock and key. Our cabinet has two locks that require two different keys for added security. The cabinet also meets DEA guidelines.

- 20g steel in powder coated beige
- Double lock that has a separate key for each lock
- Spring clip catch keeps door closed
- Can be mounted on a wall or stand alone
- One adjustable shelf and one fixed
- 23.5"W x 29.5"H x 10.5"D
- 40 lbs.



J0367m

**J0367sm Small Narcotics Cabinet.** Perfect for areas short on space or for mobile clinics. Double lock door with separate keys. Beige. 10"H x 7"W x 7"D. 6 lbs.



J0367sm

**Cold Sterilization Soaking Trays.** Durable plastic made to withstand disinfectants and sterilants. All have drain baskets that allow lifting the tray out of solution and having the solution drain back into the main container. Equipped with fitted sealed lid.

**J0882 Clear Soaking Tray, Large.** For large endoscopes or instruments. 12<sup>3</sup>/<sub>4</sub>"W x 20<sup>7</sup>/<sub>8</sub>"L x 6"H.

J0882a



**J0882b Soaking Tray with hinged lid.** Handled drain basket. 5"W x 10<sup>1</sup>/<sub>2</sub>"L x 3<sup>1</sup>/<sub>4</sub>"H.

**J0882c Soaking Tray, Small,** with removable hinged lid. One-pint volume. 3<sup>1</sup>/<sub>2</sub>"W x 8"L x 2<sup>1</sup>/<sub>4</sub>"H.

J0882c



J0882b





**Emergency and Critical Care Cart.** Keep all your critical medications and supplies at your finger tips. Lightweight aluminum construction with a modern design. Numerous standard features plus some optional features:

- Six drawers
- Breakaway lock with 100 plastic numbered seals
- 5" swivel casters, one with a brake
- Red finish, other colors available on request
- Made in USA, FOB Colorado Springs, CO
- Dimensions: 67.75"H x 35"W x 24.7"D
- Weight: 124lbs



A Grab-and-Go Top Rail/Push Handle



B Rounded Corners



C Convenient Pull-Out Shelf

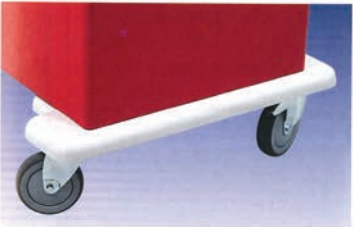

D Stabilizing Pontoon Bumpers



E Sturdy Breakaway Lock Bar



**J1315 Emergency and Critical Care Cart**

**J1315a Emergency Upgrade package:**

- "E" oxygen cylinder holder
- Height adjustable IV pole
- Two drawer trays with adjustable dividers
- Two utility hooks
- Includes **J1315** cart

**Sterilization/Disinfectant Solutions.** The use of various solutions for cold sterilization of surgical instruments is a common practice in veterinary medicine. The various types of solutions available and their proper use and limitations can be confusing.

Many solutions used for cold sterilization are actually only disinfecting the instruments and not truly sterilants. Also, many disinfecting solutions are very corrosive or harmful to surgical instruments if not used correctly. In addition, instruments should be thoroughly and properly cleaned before using any cold sterilization solution. The intended use of the instrument should also reflect what type of solution is used. For example, a superficial laceration can use instruments only disinfected, but a rigid endoscope for a laparotomy should really be sterile.

- **Sterilization Solution:** Actually provides a truly sterilized instrument as outlined by FDA guidelines. Presently only glutaraldehyde solutions meet these guidelines. This is complete destruction of all microbial life including spores. Some organisms (i.e., psuedomonas) are fairly resistant to many solutions.
- **Disinfectant:** Provides a “clean” environment that kills most microbes, but does not sterilize the instruments.

*NOTE: All solutions, be they disinfecting or sterilizing are not intended for use directly on patients when used at the correct concentration needed to truly disinfect or sterilize an instrument. All instruments taken from cold sterilization trays should be rinsed with sterile water before use.*

- **Glutaraldehyde:** A true sterilant that at the proper concentration can be used to sterilize instruments that cannot be autoclaved (i.e., endoscopes).
- **Quaternary Ammonium:** Disinfectant solution for environmental surfaces that have been properly cleaned. Quaternaries are rapid acting, non-irritating and have a low toxicity.

*NOTE: There is no solution where an instrument should simply be left in for month after month. Surgical instruments are expensive and proper care is a must to protect your investment.*

**Wavicide.** The preferred solution for items like endoscopes, that cannot be autoclaved. A 30-day, 2.65 percent glutaraldehyde sterilizing solution. It is a true sterilant versus just a disinfectant. Wavicide is similar to other glutaraldehydes (i.e., Johnson and Johnson’s Cidex).

Wavicide is similar to other solutions as in:

- 2 percent glutaraldehyde solution
- Must preclean instruments before immersion
- Must rinse with sterile water before use

Wavicide’s advantages:

- No separate activator chemical needed
- Ready-to-use, no mixing or shaking
- Unused bottled solution keeps for full year
- 30-day reuse
- Use at room temperature
- Lemon scented

**J0881 Wavicide.** 32 oz.  
**J0881g Wavicide.** One gallon.

**Pink Germicide.** An inexpensive disinfectant that allows the submerged instrument to be quickly used after just 10 minutes. It has an anti-corrosive agent that makes it safe to use with stainless steel instruments.

Germicide’s advantages:

- Quaternary ammonium compound
- Fast acting
- Low Toxicity
- Ready-to-use, no dilution needed

*NOTE: Not for direct use on patients. All soaps, detergents or lubricants should be rinsed off before immersing into Pink Germicide.*

**J0883 Pink Germicide.** One gallon.



**J0881g & J0881**

**Penrose Drain.** Simple but effective pure latex drain for a variety of clinic uses. Sterile. 16"L. 50 individual peel pkgs/case.

- J0590 Penrose Drain.** 1/4" (6.25mm).
- J0590a Penrose Drain.** 3/8" (10mm).
- J0590b Penrose Drain.** 1/2" (15mm).

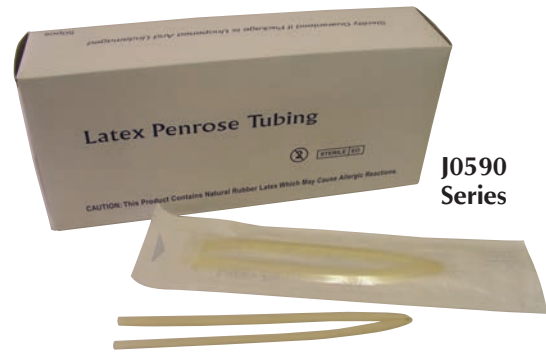

**J0590 Series**

**Silicone Thoracic Drain.** Straight with X-ray opaque line with an open end. Graduated depth markings. Six smooth oval lateral eyes. Autoclavable. 50cm L.

- J0524 Drain.** 16fr. 5.3mm
- J0524a Drain.** 20fr. 6.7mm
- J0524b Drain.** 24fr. 8.0mm

**Silicon Thoracic Body Drain Tubes.** Multifenestration with black numbered markings at 2 and 4cm from proximal hole. It has an opened end. White color. Proximal end can be trimmed to desired length.

	O.D.	I.D.
<b>J0524c</b>	12fr (4mm)	2.2mm
<b>J0524d</b>	14fr (4.67mm)	2.5mm
<b>J0524e</b>	20fr (6.67mm)	4.0mm
<b>J0524f</b>	30fr (10mm)	7.0mm

Suggested connector is J-282d4 barbed reducing connected with female luer lock and J-462 three way stop cock. Stainless steel insertion rod.

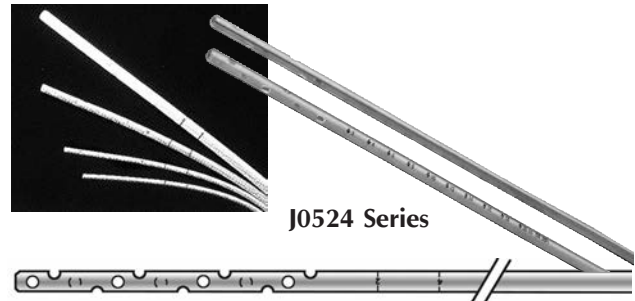

**J0524 Series**

**Stainless Stylets**

	For use with tube size	O.D.	Length
<b>J0524m</b>	12fr (J-524c))	1.3mm	40cm
<b>J0524n</b>	14fr (J-524d)	2.3mm	40cm
<b>J0524p</b>	20fr (J-524e)	3.2mm	40cm
<b>J0524q</b>	30fr (J-524f)	4.7mm	40cm

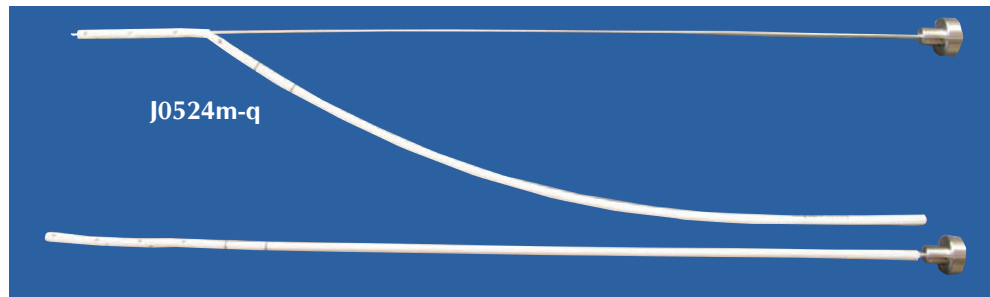

**J0524g Flexi-Drain Multi-Purpose Wound Drain.** A silicone tubular drain that may be trimmed, peeled away, or used as a whole piece for surgical wound drainage. The drain can be split along its length or trimmed to suit individual requirements. Autoclavable. 40cm L drain of 12-3mm dia. catheters.

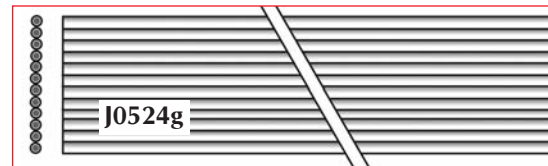

**Medical Grade Silicone Elastomer Tube.** This tubing can be used for a variety of clinical purposes including drains and feeding tubes. Autoclavable. Radiopaque marking. 50cm L.

- J0523a Elastomer Tube.** 8mm i.d. x 10mm o.d.
- J0523b Elastomer Tube.** 10mm i.d. x 12mm o.d.

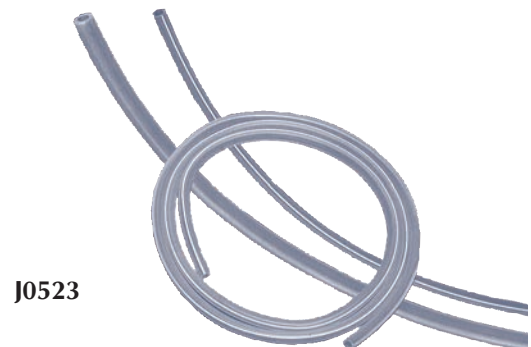

**J0523**



**Thora-Cath® Chest Tubes.** A soft silastic chest tube for pneumothorax or hemothorax. This catheter will provide drainage of the pleural space. Silicone is definitely the preferred material over pvc or nylon.

- Biocompatible silicone reduces clotting and encrustation
- Beveled end open end with two lateral eyes 1cm apart.
- Graduated at 1cm lengths
- Radiopaque stripe
- Universal hubs adapt to connectors like JorVet **J-282d1** Barbed reducing connector and suture wings. (Note: JorVet **J-282d3** is too small.) Also suggest use of 3-way stopcock (**J-462**)
- Provided with stainless steel trocar
- 14cm (5 1/2") length

<b>J0341</b>	9.6fr	(3.2mm)
<b>J0341a</b>	12fr	(4mm)
<b>J0341b</b>	14fr	(4.67mm)

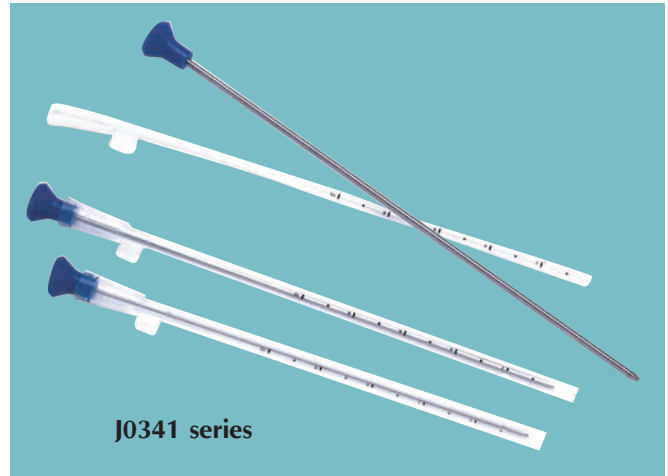

**J1186 Heimlich style one way valve.** Similar in design to Heimlic valve. Allows one way flow of chest fluids without chance of pneumothorax. One end barbed fitting, fitting chest tubes or catheter for fluid entrance. Second side is standard male luer lock for drainage.



**Closed Wound Drainage Kit.** This vacuum drain's most common use is for post-op drainage Jackson Pratt.

The kit is designed to create suction or negative pressure for draining wounds. A fenestrated silicone drain is placed into position with the aid of a stainless steel trocar. This drain is attached to a silicone bulb with a one-way valve. When the bulb is released a vacuum is created that pulls exudates out through the drain. Wound exudates can be stored, visualized, or cultured. The drain has a radio-opaque line for the entire length.

The kit consists of: a 130mm stainless steel trocar, silicone fenestrated drain and tubing, a silicone bulb, a clamp for attachment to bandage or patient.

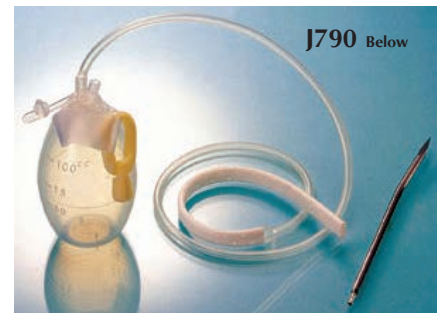

	Reservoir	Tubing	Needle
<b>J0790</b>	100cc	1.66mm i.d. x 3.2mm o.d. round	3.2mm o.d.
<b>J0790a</b>	200cc	2.88mm i.d. x 4.8mm o.d. round	4.8mm o.d.
<b>J0790b</b>	100cc	flat	3.2mm o.d.
<b>J0790c</b>	200cc	flat	4.8mm o.d.

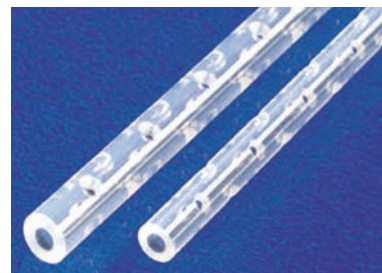

**J0641s** **Small Tattoo Plier.**  
**J0641sn** **Digits 0-9** (<sup>5</sup>/<sub>16</sub>"").  
**J0641sl** **Digits A-Z** (<sup>5</sup>/<sub>16</sub>"").

**J0642** **Standard Tattoo Plier.** Used for positive permanent livestock identification. Heavy-duty construction. Marker jaws holds four easily interchangeable letters or digits. Digits only go in one way. Positive ear release.

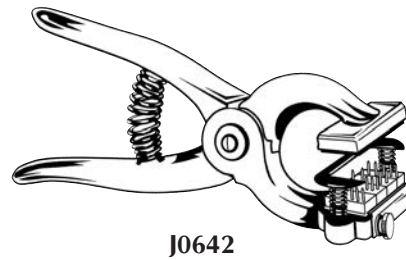

J0642

**J0643** **Standard Size Digits 0-9.**  
<sup>3</sup>/<sub>8</sub>". (not pictured)

**J0643L** **Standard Size Letters A-Z.**  
<sup>3</sup>/<sub>8</sub>". (not pictured)

**Tattoo Ink** is widely used for identification in livestock, especially cattle and swine. JotVet tattoo ink is easily read years after tattooing. Now Jorvet has expanded the range of permanent tattoo inks. Inks are available in black and green, and varied packaging.

**J0276rb** **Tattoo Ink Roll-On Bottle.** 2 oz. Black.  
**J0276rg** **Tattoo Ink Roll-On Bottle.** 2 oz. Green.  
**J0276pgs** **Tattoo Ink Tube Paste.** 1 oz. Green.  
 Collapsible metal tube with screw cap.  
**J0276pg** **Tattoo Ink Tube Paste.** 5 oz. Green.  
 Collapsible metal tube with screw cap.



J0276rg and J0276rb



J0276pg Top  
 J0276pgs Bottom

**J0276** **Small Animal Electric Tattoo Kit.** Complete tattoo kit in an attractive foam-padded case. This state-of-the-art animal marker features fingertip control for precise and accurate tattooing on the smallest of animals. Kit contains three needle bars and black tattoo ink. 110V AC current.

**J0276t** **Tattoo Ink.** Black. 2 oz.



J0276

**J0049Lta** **ID Tag Applicator.** Has specially designed head where tag slips in easily. Allows for quick and simple placement of tag in ear.

**J0049Lt** **Hauptner Mouse Ear ID Tag.** These small numbered tags are used extensively in research institutions around the world. The small metal brass tags are perfectly suited for mice and rats. They are easy to apply with metal applicator. (**J049Lta**)  
 Choose numbers 1-10,000. 100/box.

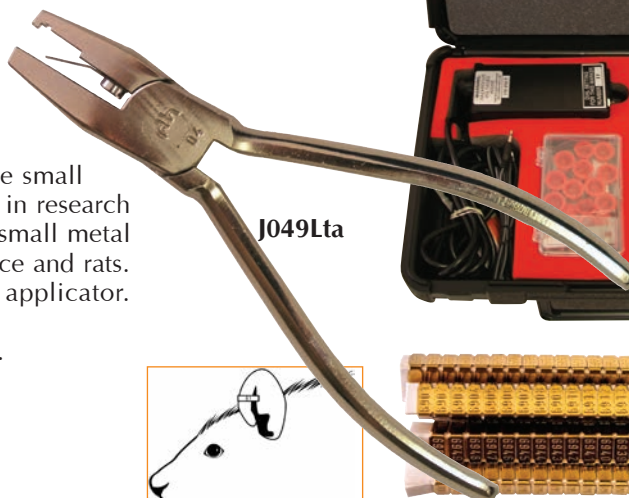

J049Lta

J049Lt



**Surgical Apparel.** A new line of surgery apparel constructed from quality non-woven materials. A wide range of products from bouffant style headwear to isolation gowns.



J0734

J0733  
J0731



J0735

J-732



J0730



J0345m

**Surgery Mask.**

- J0731** **Surgery Mask** with ties. Blue. 3-ply. 18cm x 20cm. Bulk packaged in dispensing box. 50/box. 6 bx/case.
- J0732** **Molded Face Mask** with elastic strap and malleable aluminum nose piece. Blue. 50/box. 20 bx/case.
- J0733** **Procedure Mask** with earloops. Blue. 2-ply. 50/box. 12 bx/case.

**Surgery Headwear.**

- J0734** **O.R. Nurse/Bouffant-Style Headwear.** Blue. 21". 100/box. 5 bx/case.
- J0734L** **O.R. Nurse/Super Bouffant Style Headwear.** Blue. 24". 100/box. 5 bx/case.
- J0735** **Surgeon's Cap** with rear ties. Blue. 100/box. 5 bx/case.

**Shoe Cover**

- J0730** **Disposable Shoe Cover.** Non-conductive and non-skid. Blue. Universal size. Bulk packaged in dispensing box. 100/box.

**Disposable Lab Coats and Jackets.** These inexpensive lab coats are great for general use around the clinic and give a professional look. Constructed of 3-layer SMS non-woven fabric that is both breathable and fluid resistant. Fashioned with a snap button front and white knit cuffs and collar. Can be washed or autoclaved up to five times. 10/pkg.

NOTE: Sizes tend to be on the large size.

**Disposable Lab Jacket.** Hip length. (not pictured)

- J0945sb** **Jacket.** Ciel Blue. Small.
- J0945mb** **Jacket.** Ciel Blue. Medium.
- J0945Lb** **Jacket.** Ciel Blue. Large.
- J0945xb** **Jacket.** Ciel Blue. X-Large.
- J0945sg** **Jacket.** Teal Green. Small.
- J0945mg** **Jacket.** Teal Green. Medium.
- J0945Lg** **Jacket.** Teal Green. Large.
- J0945xg** **Jacket.** Teal Green. X-Large.

**Disposable Lab Coat.** Knee length.

- J0946sb** **Coat.** Ciel Blue. Small.
- J0946mb** **Coat.** Ciel Blue. Medium.
- J0946Lb** **Coat.** Ciel Blue. Large.
- J0946xb** **Coat.** Ciel Blue. X-Large.
- J0946sg** **Coat.** Teal Green. Small.
- J0946mg** **Coat.** Teal Green. Medium.
- J0946Lg** **Coat.** Teal Green. Large.
- J0946xg** **Coat.** Teal Green. X-Large.

- J0345m** **White Plastic Disposable Aprons.** All purpose utility garment is water, oil, and chemical resistant. Useful for a lot of the "dirty" jobs around the clinic. Dispensing box of 100. 28" x 46" long.



J0946  
Coat



**Isolation/Barrier Gown.** The spread of highly contagious diseases is a real threat in the veterinary hospital. All hospital personnel should wear isolation gowns to help reduce disease transmission when dealing with a contagious patient.

**Disposable Surgery Gowns are classified as:**

**Regular Procedure Gown:** Sontara or SMS fabric with no extra reinforcing or fluid resistant panels.

**Extended Procedure Gown:** Sontara or SMS fabric with plastic panels in the chest area and sleeves.

In addition, gowns can have an open back or a wrap-around with covered back. Open back gowns are cheaper because of less material, but obviously offer less coverage.

Most gowns are either large or extra-large.



**Isolation/Barrier Gown.** Fluid resistant. Yellow with full back. Knit fabric wrist cuffs. Universal size, full length with ties. Disposable. 50/case.

**J0736 Isolation/Barrier Gown.**



**Isolation Gown.** Poly-coated with thin film of protective plastic for fluid repellency. Blue with elastic wrist cuffs. Universal size, full length with ties. Disposable. 50/case.

**J0737 Isolation Gown.**



**Sterile Disposable Surgery Gown.** Packed in a protective clear bag with a header, wrapped in standard CSR wrapper. Hand towel included. Regular procedure. Full back with wrap-around style. Knit fabric sleeves. Light blue.

**J0738 Gown. Large.**  
**J0738L Gown. X-Large.**

*NOTE: Gown can be machine washed and resterilized.*

**Disposable Surgery Gown.** Full back with wrap-around style and knit sleeves. Light-blue fabric. Non-sterile. Can be safely autoclaved and even washed.

- J0739a Sontara Fabric Gown. Large.**
- J0739c Sontara Fabric Gown. Medium.**
- J0739b Sontara Fabric Gown. X-Large.**
- J0739m SMS Fabric Gown. Large.**
- J0739p SMS Fabric Gown. Medium.**
- J0739n SMS Fabric Gown. X-Large.**

Extended procedure gowns are reinforced with impervious fabric along the length of the lower arms and midchest to bottom of abdomen.

- J0738xp Extended Procedure. Large.**
- J0738xpl Extended Procedure. X-Large.**

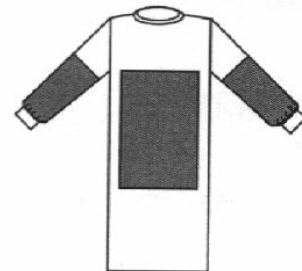

from Vet Surgical Resources

## Sustainable Scrubs and Surgical Apparel

**Fabric:** 55% Bamboo, 25% Cotton, and 20% PET—from recycled water bottles  
This fabric was designed specifically for our scrubs and has many benefits over traditional poly/cotton and 100% cotton scrub materials.

Benefits of Our Bamboo Fabric:

- Softer
- Superior odor control
- Dries 1.5 times faster than cotton
- Sustainable Fabric, making it more environmentally friendly

### Fashion Mock Wrap Top

Flattering style mock crossover front and elastic-back waistline with self-fabric detailing, and an improved cut gives the mock wrap top a very stylish feminine fit. It has reinforced stitching throughout, two lower pockets, side vents, high quality Bamboo/Cotton blended fabric for added comfort, and 28" length for improved coverage. Sizes: XS - 3XL.

	X-small	Small	Medium	Large	X-large	2XLarge	3XLarge
Ciel Blue	J1171cxs	J1171cs	J1171cm	J1171cL	J1171cxL	J1171c2xL	J1171c3xL
Navy Blue	J1171nxs	J1171ns	J1171nm	J1171nL	J1171nxL	J1171n2xL	J1171n3xL
Jade Green	J1171jxs	J1171js	J1171jm	J1171jL	J1171jxL	J1171j2xL	J1171j3xL

### Women's Four Pocket Top

A very popular style as it is cut for a woman's body, providing a stylish fit while also being extremely functional. Single breast pocket with a pencil divider, two lower side pockets, and a Bamboo/Cotton blend for added comfort, reinforced stitching throughout, and 28" length for improved coverage. Sizes: XS -3XL.

	X-small	Small	Medium	Large	X-large	2XLarge	3XLarge
Ciel Blue	J1172cxs	J1172cs	J1172cm	J1172cL	J1172cxL	J1172c2xL	J1172c3xL
Navy Blue	J1172nxs	J1172ns	J1172nm	J1172nL	J1172nxL	J1172n2xL	J1172n3xL
Jade Green	J1172jxs	J1172js	J1172jm	J1172jL	J1172jxL	J1172j2xL	J1172j3xL

**Women's 7-Pocket Utility Cargo Pant:** This utilitarian pant has enhanced functionality and comfort as it has an extra-wide elastic waistband along with a drawstring and cut to cover your back-side when you bend. To ensure you have room for everything you need to carry on a daily basis, it has two side and two cargo pockets, and one pocket-in-pocket, full cut legs with a 31" inseam, and reinforced stitching throughout. Sizes: XS -3XL.

	X-small	Small	Medium	Large	X-large	2XLarge	3XLarge
Ciel Blue	J1174cxs	J1174cs	J1174cm	J1174cL	J1174cxL	J1174c2xL	J1174c3xL
Navy Blue	J1174nxs	J1174ns	J1174nm	J1174nL	J1174nxL	J1174n2xL	J1174n3xL
Jade Green	J1174jxs	J1174js	J1174jm	J1174jL	J1174jxL	J1174j2xL	J1174j3xL

Standard: 31" Inseam

**Surgical Gown:** Full sleeves, tunnel belt, neck ties, stand-up collar, snug knit cuffs, tie back and extra thick bamboo/cotton blended fabric for additional barrier protection. Bamboo/Cotton blend provides a breathable gown to help keep the surgeon and assistant cooler than a poly/cotton gown. Sizes: S - 2XL. Comes in Ciel Blue only.

	X-small	Small	Medium	Large	X-large
Ciel Blue	J1175cxs	J1175cs	J1175cm	J1175cL	J1175cxL

**Sustainable benefits of Bamboo:** Less pesticides or fertilizers needed: cotton uses 10% of agricultural land mass, but used 25% of the world's pesticides. Bamboo absorbs 35% more carbon dioxide than trees. Bamboo requires no irrigation or replanting. Cotton consumes several times the amount of water per acre. Bamboo yields 60 tons per acre while cotton only 2 tons per acre. Bamboo grows up to several inches per day in all types of weather conditions.



Available colors:



Ciel Blue



Navy Blue



Jade Green

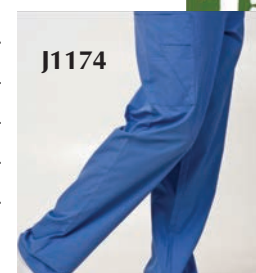
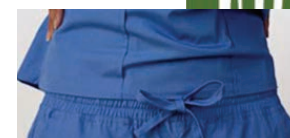

## Unisex Scrubs

"The fit, comfort, and quick drying of the Jorvet scrubs have made them an instant hit with our hospital staff." —Terri Kern, HR manager, Sylvania Vet Hospital

**Unisex Scrub Top:** Fully reversible V-neck top with set-in sleeves, double stitched seams, one left breast pocket outside and one right breast on the inside, all pockets have reinforced corner bartacks for improved durability. Sizes XS-3XL.

	X-small	Small	Medium	Large	X-large	2XLarge	3XLarge
Ciel Blue	J1170cxs	J1170cs	J1170cm	J1170cL	J1170cxL	J1170c2xL	J1170c3xL
Navy Blue	J1170nxs	J1170ns	J1170nm	J1170nL	J1170nxL	J1170n2xL	J1170n3xL
Jade Green	J1170jxs	J1170js	J1170jm	J1170jL	J1170jxL	J1170j2xL	J1170j3xL

**Unisex Scrub Bottom:** Drawstring Waist, a back right hip pocket, cargo pockets on right and left sides, reinforced corner bartacks for improved durability, and full cut legs (31" inseam standard).

	X-small	Small	Medium	Large	X-large	2XLarge	3XLarge
Ciel Blue	J1173cxs	J1173cs	J1173cm	J1173cL	J1173cxL	J1173c2xL	J1173c3xL
Navy Blue	J1173nxs	J1173ns	J1173nm	J1173nL	J1173nxL	J1173n2xL	J1173n3xL
Jade Green	J1173jxs	J1173js	J1173jm	J1173jL	J1173jxL	J1173j2xL	J1173j3xL

**J1176 Surgical Cap:** Made from the same Bamboo/Cotton blended fabric as the scrubs. This makes these surgical caps very comfortable, absorbent, and breathable. They have a scotch tie back. One size in Ciel Blue only.



## Unisex Scrub Sizing:

	X-small	Small	Medium	Large	X-large	2XL	3XL
Size	0-4	6-8	10-12	14-16	18-20	22-24	26-28
Chest	32-34	35-37	38-40	42-44	46-48	50-52	54-56
Waist	23-25	26-28	29-32	34-36	38-40	42-44	46-48
Hip	32-34	35-37	38-40	42-44	46-48	50-52	54-56

Unisex inseams approximately 31"

## Women's Scrub Sizing:

	X-small	Small	Medium	Large	X-large	2XL	3XL
Size	0-4	6-8	10-12	14-16	18-20	22-24	26-28
Chest	32-34	33-35	37-39	40-43	44-47	48-51	52-55
Waist	24-25	26-27	28-30	31-34	35-38	39-42	43-46
Hip	35-36	37-38	39-41	42-45	46-49	50-53	54-57

Women's Pant inseams approximately 31".



**X-ray Aprons.** JorVet offers a wide range of x-ray aprons designed for safety but offering a colorful variety of fabric choices.

**X-Ray Aprons.** Two different styles are offered.

- Shoulder pads included
- Attractive maroon and black paw design
- 0.5mm Pb equivalency

**J0676m Apron,** Quick release buckle, small 32" length.

**J0676mL Apron,** Quick release buckle, large 36" length.

**Velcro tie apron.** Features two hook and loop (Velcro) flaps at the waist which aid in relieving weight off of the shoulder. Its comfortable fit is attained by varying the position of the flaps.

**J0676wa Small.** 32" length. Maroon with black paw print design.

**J0676wb Small.** 32" length. Maroon with black paw print design.

**J0676wm Large.** 36" length. Royal blue with white paws.

**Additional Fabric and Color Choices.** Note: Small length 34", large length 38". Width small 22" and large 24". Other sizes available—please inquire.



**Royal Blue with White Paws**

**J0676mb** Buckle small

**J0676mbL** Buckle large

**J0676wm** Velcro small

**J0676wml** Velcro large

**Brown with Black Paws**

**J0676mc** Buckle small

**J0676mcL** Buckle large

**J0676wc** Velcro small

**J0676wcl** Velcro large

**Wild Cat Pink**

**J0676md** Buckle small

**J0676mdl** Buckle large

**NEW**



**Flower Power**

**J0676mh** Buckle small

**J0676mhl** Buckle large

**J0676wh** Velcro small

**J0676whL** Velcro large

**NEW**



**Farm Animals**

**J0676mi** Buckle small

**J0676mil** Buckle large

**J0676wi** Velcro small

**J0676wil** Velcro large

**NEW**



**Leopard**

**J0676mm** Buckle small

**J0676mml** Buckle large

**J0676wm** Velcro small

**J0676wml** Velcro large

**NEW**



**Zebra**

**J0676mk** Buckle small

**J0676mkl** Buckle large

**J0676wk** Velcro small

**J0676wkl** Velcro large

**Diamond Ripstop:** Fabric is very tear resistant



**Royal Blue**

**J0676mj** Buckle small

**J0676mjL** Buckle large

**J0676wj** Velcro small

**J0676wjL** Velcro large

**Economy x-ray aprons.** This is a standard tie-on strap. Shoulder pads included. Royal blue nylon.

**J0676ta** **Small** 32" length.

**J0676tb** **Large** 36" length.



**J0676tb** **J0676ta**

**J0678n** **Thyroid Collar.** New style Thyroid Collar offers a trim yet shielded and comfortable design. Includes binding and rear hook and loop closure.

- Standard protection: 0.5mm Pb Equivalency
- Royal blue nylon

**J0679n** **Thyroid Collar.** Preventing exposure to sensitive thyroid glands is important. 18.5" length, 10" x 6.5" bib, includes edge binding for comfort. Rear hook/loop closure.

**Matching color/fabric:** you can match thyroid collar with apron fabric choices. Insert the last letter of the apron code (not counting 'L'). For example, J0679nB would be royal blue with white paws. See page 346 for fabrics.



**J0678n**



**J0679n**

**J0676e** **Wrap around eyewear** features molded wrap styling in durable tortoise nylon frame with leaded side shields for added protection. Standard protection: front & side lenses 0.75mm Pb equivalent optical lead glass.

**J0676eh** **Hornet Frame.** Popular wrap around coverage features foam brow bar for comfort and rubber temple tips and nose pads for non-slip wear. Includes fitted side shields. Weighs just 64 grams.

**J0676ef** **Ultra Wrap Around Fit-Over.** Fits comfortably over most conventional prescription eyewear while providing front and side lens protection.



**J0676e**



**J0676eh**



**J0676ef**

**NEW**

**Barium Sulfate** 60% w/v suspension has long been the standard in providing excellent results in contrast studies of the G.I. tract. Flavored formula. (Not pictured.)

**J1350** **Barium Sulfate.** 12 oz. bottle

**J1350a** **Barium Sulfate.** 64 oz. volume jug

**J0677x Lead Gloves-Vinyl.** Seamless lead vinyl gloves are a 15" one piece dip molded glove with supple vinyl cover and foam liner. Burgundy color. Standard protection 0.5mm Pb equivalency. *As seen on page 333.*

**J0677m Vet Mitts.** Features a palm slit allowing fingers to exit for freedom of movement but still cover top of hand during radiology. Royal blue nylon. Standard protection: 0.5mm Pb equivalency

**J0677p Open Palm Mitts:** shields the back of the hand and features hook and loop strap closure across the palm for quick removal. Covered in dark blue webblon. Standard protection: 0.5mm Pb equivalency.



**X-Ray Glove.** 5 Finger molded glove for improved dexterity. Seamless lead vinyl dipped gloves. Sterilizable by ethylene oxide. Color beige. Can be cleaned with mild soap. Standard protection: 0.5mm Pb equivalency.



J0676v series

- J0676va Small
- J0676vb Medium
- J0676vc Large

**J0676h Heavy duty chrome hanger:** chrome plate  $\frac{3}{16}$ " recommended to protect x-ray aprons and increase product life. Hanger will hold up to 50lb (22.7kg)



J0676h

**J0676r Peg racks:** economical for the quick and easy storage of up to 4 aprons. Powder coated steel construction, easy installation. 24" x 4" weight 3lbs

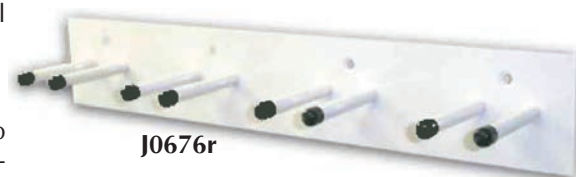

J0676r

**J0676t MultiGlove and apron rack** is ideal for storing multiple pairs of gloves and aprons. Also convenient to hold thyroid collars. Mounts quickly and easily to any wall and requires only a space 19" wide powder coated heavy steel construction. 19" x 20" weight 10lb



J0676g

**J0676g Combination Apron and Gloveholder:** offers quick convenient storage for an apron and a pair of gloves. Powder coated heavy steel construction. 23 $\frac{3}{4}$ " (w) x 17" (h) wt 8.5 lbs.

*NOTE: Never store aprons in a folded position!*

**Radiographic Reference Ball.** Taking radiographs where the area of interest is not close to the plate creates some challenges in scaling. This is true of both digital and analogue systems. When using the radiograph for templating implants e.g. total hip replacement it is very important to make accurate measurements.

The Reference ball is 25mm in diameter and is attached to a stable base by a flexible neck which allows the ball to be placed at the same level above the plate as the area of interest. Using a spherical object as a reference eliminates errors created by ruler type reference which might not be quite parallel with the plate.

**J1185b Radiographic Reference Ball 25mm dia**

**J1185c Radiographic Reference Ball 10mm dia**



J01185b and c





**JorVet GI Magic Beads.** Is that a GI foreign body or not? Liquid Barium is useful for diagnosing suspected GI foreign bodies on radiographs. However, partial obstruction can be difficult to interpret on radiographs even with barium. The use of radiographic markers before barium administration can be really useful in suspected foreign bodies, invasive neoplasia, or gastric motility disorders such as Heus. Radiograph markers are:

- Radiopaque small beads of 1.5mm and 4.7mm diameter
- Stainless noncorrosive inert material
- Readily pass through normal GI tract
- Beads are packaged in small gelatin capsules for ease of administration
- Considerably less expensive than Barium impregnated polystyrene beads
- Keep in clinic ready to go when that emergency case presents itself

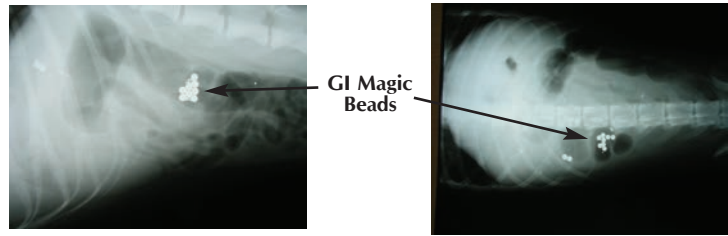

**J1146 Small pack for cats and small dogs.** Each dose consists of 2 smaller gelatin capsules with 30 x 1.5mm beads and 10 x 4.7mm beads. Total of 5 doses.

**J1146a Large dose pack for larger dogs over 30 lbs.** Each dose has 1 larger gelatin capsule with total of 30 x 1.5mm beads and 10 x 4.7mm beads. Total of 5 doses.

**J1146b Combo pack,** 2 doses of both small and large packs.

**J0684 X-Ray Measuring Caliper.** Getting the correct thickness of your patient is critical to proper KVP setting and quality diagnostic radiographs. Measurements in centimeters only. Stainless steel.

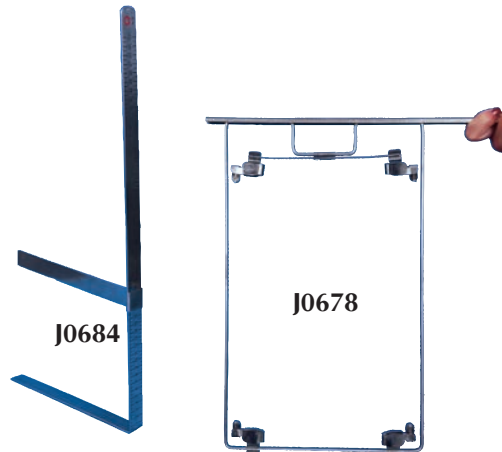

**Metal Film Developing Hanger.** These stainless steel hangers hold the X-Ray film while in the developing or processing tanks. They clip on to the four corners of the film.

- J0678 Hanger,** 8" x 10".
- J0678a Hanger,** 10" x 12".
- J0678b Hanger,** 14" x 17".

**X-Ray Positioning Sand Bags.** New regulations regarding exposure to radiation make it difficult to hold animals in position while taking radiographs. These bags are made of heavy nylon navy blue canvas filled with sand (not included). Heavy-duty plastic liners provide leak proof use. Complete set includes:

- One 23" x 7" pillow weight
- One 11" x 11" pillow weight
- Body sling with snap hooks use either
- Two 8" x 8" hanging weights OR two 6" x 17" hanging weights
- One body sling

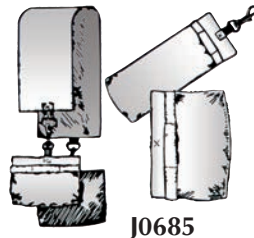

**J1185 X-Ray Markers.** This set of two x-ray markers (L and R) does more than give the side orientation of an x-ray. It has a cm scale that provides measurements. This is useful at sending digital x-rays to other parties that may have a different software or type of digital radiography. The markers are 50mm long and marked in 5mm intervals. Set of 2.



**J1185a X-ray marker Holder.** This device has a malleable arm that holds the x-ray marker at the same height as the bone under investigation. This helps to eliminate the magnification effect of standard radiography.

**J0806y Single Bank X-ray illuminator.** Single bank constructed of all steel. High luster white powder coat. One piece plexiglass panel with 14"x17" viewing area. Three-bulb configuration. Roller gravity grips. 110V AC Power. 17<sup>1</sup>/<sub>2</sub>"(w) x 23" (h) x 4<sup>3</sup>/<sub>8</sub>" (d)

**J0806z Double Bank x-ray illuminator** as above but with two 14"x17" viewing areas. Individual on/off switch, 5 bulb configuration. 32"(w) x 23"(h)x 4<sup>1</sup>/<sub>2</sub>" (d)

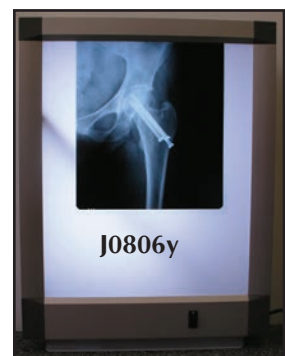

**NEW**



*I can't stay this way  
without help!*

**Gel Positioners** are designed to aid in positioning patients for either surgery or radiographs. They provide firm but comfortable support.

- Made of viscoelastic polymer so it has a soft tissue-like feel
- Provides constant support and will not bottom out
- Free from latex, silicon, and plasticizer
- Will not leak or flow
- Radiolucent
- Reusable
- Easy to clean with standard disinfectants
- Compatible with warming blankets
- 2 year warranty

**Flat Bottom Positioner.** (Shaped like a loaf of bread)

- J1282 Flat Bottom.** 12"L x 4"W x 3<sup>3</sup>/<sub>4</sub>"H
- J1282a Flat Bottom.** 16"L x 4"W x 3<sup>3</sup>/<sub>4</sub>"H
- J1282b Flat Bottom.** 20"L x 4"W x 3<sup>3</sup>/<sub>4</sub>"H
- J1282c Flat Bottom.** 8"L x 3"W x 3"H
- J1282d Flat Bottom.** 6"L x 3"W x 3"H



**J1282**



**J1282**

**Trapezoid shaped gel positioner.**

- J1282e Trapezoid.** 10"L x 7"W x 3<sup>1</sup>/<sub>2</sub>"H

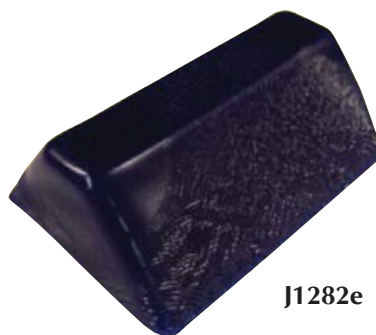

**J1282e**

**Gel Contoured Positioners** are commonly referred to as sandbags. These are filled with gel which offers pressure redirection compared to harsh heavy rigidity of an actual sandbag.

- J1283 Standard gel filled sandbag.** 10"L x 4<sup>1</sup>/<sub>2</sub>"W x 2"H
- J1283a Large gel filled sandbag.** 14"L x 4<sup>1</sup>/<sub>2</sub>"W x 2<sup>1</sup>/<sub>4</sub>"H



**J1283**

*Note: Gel positioners are not warranted against damage caused by chewing or nail tears.*

**Anatomical Models.** Want to educate your clients and increase their compliance? The use of 3-dimensional models is much more effective than words or pictures. The use of anatomical models as a client education tool is widespread in human medicine. JorVet's wide range of anatomical models offer:

- Excellent detail of veterinary specific anatomy, not human models
- Many models offer examples of common pathology on one side and normal anatomy on the other
- All models use urethane, acrylic plastic materials
- Teeth can be removed from socket

Simply, when clients better understand their pet's condition they are more likely to accept the treatment you suggest.

**Dental Model.** Beautiful clear acrylic models are great demonstration tools for clients. The entire dental arcade is shown in anatomically correct presentation. The shape of roots can be seen. Teeth are natural color. Approximate natural size.

- J0770d Dental Model.** Canine. 6".  
**J0770f Dental Model.** Feline. 4".  
**J0770df Set of 2** Canine & Feline Models.

**Pathology Dental Model.** These realistic models are all in natural colors of gum tissue and teeth. One side shows examples of over 20 common dental problems, the other side shows normal anatomy. Accompanied with a laminated color chart identifying all pathologies. Constructed of virtually unbreakable urethane.

- J0771 Dental Model.** Canine.  
**J0771c Dental Model.** Feline.  
**J0771s Set of 2** Canine & Feline Models.

**J0772 Ear Model.** Otic exams are a common daily practice for veterinarians. However, the client never sees what the veterinarian sees. This cut-away model outlines the normal anatomy of the ear plus associated nearby structures. It also illustrates common ear disease like otitis externa, polyps and even has a foxtail. The pinna shows a hematoma and a fly strike. Accompanied with a laminated color explanatory chart. Hand painted in beautiful colors. 3 1/2"W x 6"H x 2"D.

**J0773 Heart Model** with adult heartworms. This two-piece model offers a dramatic representation of what a heartworm infection can look like. Accompanied with a laminated color explanatory chart. Hand painted in beautiful colors.

**Orthopedic Model.** These models give minute details of various important joints and orthopedic structures. All are made from urethane plastic. Mounted on a wood base, yet still removable for handling and examination.

- J0775 Canine Hip and Lower Vertebrae.**
- One hip joint features normal anatomy, the other shows pathology, (i.e., hip dysplasia)
  - Normal and abnormal inter-vertebral discs
  - Spinal cord and nerve roots are in yellow
  - Lumbosacral joint
  - Wood base 7" x 9"

**J0776 Canine Stifle.** Shows all ligaments and related structures like the meniscus. Only normal structures are shown. Wooden base 4 1/2 x 6".





**Aspiration/Suction Unit** provides portable powerful suction via an aspirator pump motor. Uses include: intraoperative suction of blood or body fluids; and, keeping field of vision clear or sample collection with endoscope attachment. 69db at 1 meter.

Features:

- 800cc storage canister
- Aspiration range 0-27" Hg
- Compact 5 1/2"W x 14"L x 10 1/2"H (14cm x 35cm x 26cm)
- Inline hydrophobic filter protects motor
- Powerful 1/5 hp motor, most other units only 1/10 hp
- Lightweight. 12.4 lbs.
- Five-year limited warranty

**J0459 Suction Unit.** (suction handle not included)

**J0459d1 Cannister.** 800cc (will work with other suction units). Includes lid.

**J0459d1a Cannister,** 1200cc

**Attachments.** Will work with any unit.

**J0488 Surgical Suction Hose.** 1/4" i.d. x 6'. Sterile. 1/pkg.

**J0488L Surgical Suction Hose.** 1/4" i.d. x 12'. Sterile. 1/pkg.

**J0489 Yankauer Suction Handle.** For aspiration of fluids during surgical procedures. Nylon. Can attach to J-488 suction hose, as shown. Sterile. 1/pkg.

**J0489a Yankauer Suction Handle** with thumb control vent. Same as **J0489**, only with a thumb control vent. Small vent hole on the handle creates suction when blocked by thumb. (not pictured)

**J0459d1 Storage Canister.** 800cc. Fits most other suction units.

**Yankauer Metal Suction Handle.** Small removable tip has six vertical holes for suction. Fits standard suction hose. 22cm L.

**J0489m Yankauer Handle.** German-made.

**J0489me Yankauer Handle.** Economy.

**J0489p Poole Suction Handle.** Distal 1/3 end is vented with many holes. Fits standard suction hose. Screws apart for easy cleaning. Stainless steel. 8mm dia. 22cm L.

**J0489f Frazier Suction Tube.** Stainless steel angled tip. Finger tip air cut off. Cleaning stylet. 7fr dia. (2.3mm).

**Suction Catheter.** These long and thin PVC catheters are designed to hook up to standard suction hose. These are useful in aspirating diagnostic samples or removing fluids in very narrow key hole procedures. A common use is insertion inside an endotracheal tube for fluid samples from the lungs.

Open tip with two lateral eyes. Side vent allows suction control via simple thumb placement. Sterile. 18"L. 5/pkg.

**J0695 Suction Catheter.** 6fr.

**J0695a Suction Catheter.** 8fr.

**J0695b Suction Catheter.** 10fr.

**J0695c Suction Catheter.** 14fr.

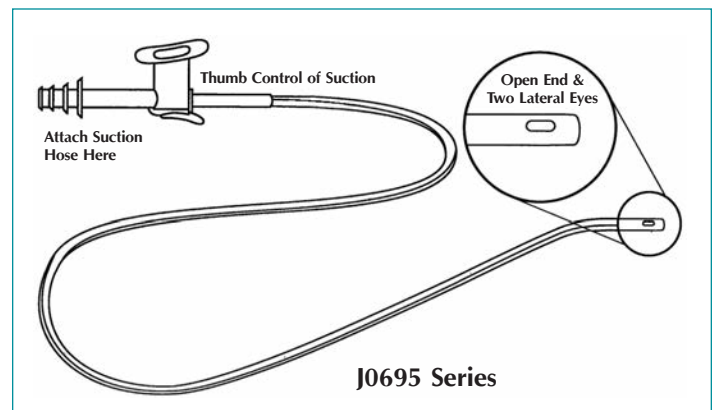

**Pediatric Scale.** Accurate weights of your smaller patients are important. Small changes in weight can indicate disease. An accurate weight is also important for proper dosing of medication plus your clients like to know their animal's weight. Tray dimension: 10<sup>1</sup>/<sub>2</sub>" x 21<sup>1</sup>/<sub>2</sub>". Scale dimensions: 10<sup>1</sup>/<sub>2</sub>" x 10<sup>1</sup>/<sub>2</sub>" x 1<sup>1</sup>/<sub>2</sub>".

- Accurate, instant and easy-to-read LCD display, 4 digits 1/2"H
- Lock-in weight with zero/tare function
- Automatic power off function
- 44 lbs. (20 kg) capacity, 20kg x 10g, 44lbs x 1/2 oz
- Portable, 5<sup>1</sup>/<sub>2</sub> lbs.
- Display not attached to base of scales, attaches via cord.

**J-825 Pediatric Scale.**

**Pediatric Scales.** This scale is particularly suited to the veterinary industry. With a capacity of 44 lb (20 kg) and readability of 1/2 oz (10g), the scale will accurately weigh infants or small animals. The scale has a "Hold" feature that will capture an unstable weight and keep it on the display for recording after the weight is taken off. The scale is offered in two models and can operate on battery (single 9VDC) or AC (adapter included). The scale comes with a stainless steel weighing tray.

**J-825ss** 20 kg x 10 g (44 lb x 1/2 oz)

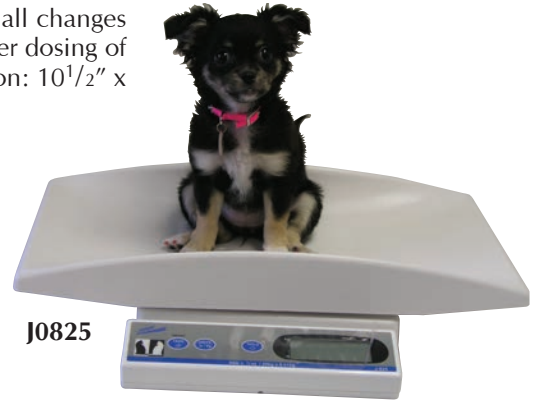

J0825

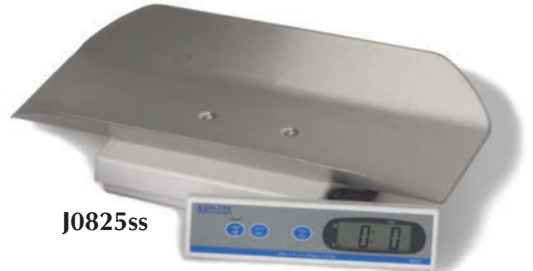

J0825ss

**Triple Beam Pan Balance.**

- Weighing Units: grams
- Readability: 0.1 g
- Capacity: 610 g (without attachment weights)
- Beam Calibrations: 10 x 0.1 g / 100 x 10 g / 500 x 100 g
- Dimensions: scale — 18" (L) x 3" (w) x 5.5" (H), weighing platform — 6 diameter (round)



J0826x

**J0826x Triple Beam Pan Balance.**

**Walk-On Platform Scale.** Clients love to weigh their pets on this walk-on scale. Special software will capture the weight of a moving animal. Stainless steel top with rubber mat to avoid slippage. all units are pre-calibrated and simple to install using the adjustable feet for leveling.

- Weighs Kg (0.1) or pounds (0.2) units with tare function
- Weighs up to 250 Kgs or 500 lbs
- Remote LCD display with 15' cord for wall mounting
- 22"W x 36"L x 2"H
- AC with 4 AAA batteries

**J0825pm Walk-On Platform Scale.** 36"L. Has 6' power cord for wall mounting.

**J0825qm Walk-On Platform Scale,** 42"L. **MOST POPULAR**

**J0825qmfs Optional floor stand** for J0825pm and J0825qm. Height 39".

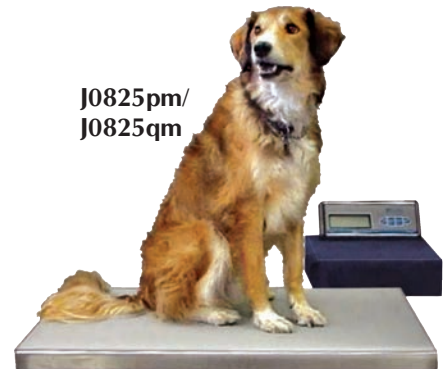

J0825pm/  
J0825qm



J0825qmfs

**J0825m JorVet Portable Digital Scale**

- Built-in LCD display
- Requires 4x AA batteries (not included)
- ABS plastic with removable tray
- Inside diameter of the tray is 23"L x 11"W
- Capacity 1/2oz - 44lbs (5g - 20kg)
- Operator keys: on/off, units, hold
- Hold features allow operator to secure animal and still observe weight
- Measures in pounds and kilograms
- Weighs 9lbs
- LCD display has blue background



J0825m



J0826b

**Pocket Balances.** This elegant-looking product offers unparalleled weighing performance, with the advantage of low cost and affordability. Standard features include grams, ounces, penny-weights and troy ounce weighing modes, parts counting and auto power off to enhance battery life. Offered in a stylish and tough ABS case with a useful top plate cover that protects the weighing platform from accidental damage, while doubling as a draft shield for more accurate weighing. Batteries and a multilingual user instruction manual are included.

- Modes: weighing (g, oz, dwt, ozt), piece counting, auto power off (standard 120 seconds)
- Function Keys: on/off, tare (zero), count, mode (unit switching)
- Display: 0.5" (13 mm) 7 segment LCD
- Temperature limits: 10° C to 35° C
- Power: 2 x 1.5 V AAA batteries (included)
- Dimensions
  - scale: 5.2" x 3.2" x 0.9" (133 mm x 81 mm x 23 mm)
  - weighing platter: 2.4" x 3.0" (61 mm x 75 mm)
- Weight: 0.3 lbs (135 g)

**J0826b** 500 g x 0.1 g / 17.640 oz x 0.005 oz / 320.0 dwt x 0.1 dwt / 16.080 ozt x 0.005 ozt



J0825em

**J0825em Jorvet Equine Platform Scale.** Accurate and reliable scale for weighting horses and other large animals up to 3000 lbs in one pound increments. LED indicator with 20 hours battery life. Detachable indicator allows for easy recharging from AC power outlet. Dimensions 40"W x 79"L x 4"H.

Predrilled holes to allow for plywood protective sheet on scale itself (not provided). 242 lbs. Drop ship item only. Freight added to invoice. Truck delivery only. For more information please call Jorgensen Labs customer service.



J0825ems

**J0825ems Indicator stand** to allow convenient display of scale indicator. 36" Height. For use with **J0825em** Jorvet Equine Scale.



J0826q, r, s

Standard model

**Samson digital hand-held scale.** A modern scale offering all the qualities of a traditional hanging balance with the simplicity, convenience and accuracy of digital operation. Large easy to read LCD display. "Hold" feature for one person operation on heavier loads. A robust, compact and lightweight (0.95 lb/430 g) portable scale. A carrying pouch is supplied for protection when not in use. Complete with weighing handle and battery.

**J0826q** 10 kg x 0.01 kg (22 lb x 0.02 lb/1/4 oz)

**J0826r** 25 kg x 0.02 kg (55 lb x 0.05 lb/1/2 oz)

**J0826s** 45 kg x 0.05 kg (99 lb x 0.1 lb/1 oz)



**Cryosurgery** is an accepted treatment method in veterinary surgery. **JorVet's Cryogun®** is a versatile hand-held container filled with liquid nitrogen from a larger storage Dewar. Attached probes fit for a variety of applications.

**J0810 Cryo Kit.** Small animal. This kit uses the mini cryogun for ease of handling. Includes three different apertures: 18mm cryochamber, 1cm flat probe, malleable extension.

Mini cryogun 25cm H, 0.3kg. 0.3-liter capacity.

**J0810a Cryo Kit.** Large animal. For use in large animal or mixed practice. Additional probes or attachments can be added as needed. Includes three different apertures: 18mm cryochamber, 1cm flat probe, malleable extension.

Standard cryogun 28cm H, 0.5kg. 0.5-liter capacity.

*NOTE: Open spray attachments are used for lesions on patient's outside body. The bigger the aperture, the larger the volume of spray dispensed.*

**Opening Site Aperature.** Straight Spray Attachments.

**J0810aa Attachment.** 0.04". **J0810d Attachment.** 0.016".

**J0810b Attachment.** 0.031".

**J0810c Attachment.** 0.022". Most popular.

**Straight Spray Extension,** used to reach deep recessed areas.

**J0810ca Spray Needle.** 16g x 1 1/2".

**J0810cb Spray Needle.** 18g x 1 1/2".

**J0810cc Spray Needle.** 20g x 1 1/2".

**J0810cd Straight Spray Extension.**

**J0810ce Bent-Tip Spray Extension.** 20g x 3".

**Cryochamber.** Permits precise confined spray. Liquid nitrogen pools over deep lesions. Suggested use with malleable extensions (e.g., **J-810ra**)

**J0810da Cryochamber.** 6mm. **J0810dd Cryochamber.** 18mm.

**J0810db Cryochamber.** 10mm.

**J0810dc Cryochamber.** 15mm.

*Closed Probe. Only the tip is cooled via a hollow tube down the probe. A side port vents the liquid nitrogen.*

**Conical-Shaped Closed Probe.** These probes are inserted into large or ulcerated lesions, thereby markedly increasing the surface area of the freeze.

**J0810ea Probe.** 1mm. **J0810ed Probe.** 4mm.

**J0810eb Probe.** 2mm. **J0810ef Probe.** 5mm.

**J0810ec Probe.** 3mm. **J0810eg Probe.** 6mm.

**J0810eh Sharp Pointed Conical Closed Probe.**

**Flat Closed Probe.** Circular, and useful for wide flat lesions (e.g., squamous cell carcinoma and sarcoids).

**J0810fa Probe.** 1.0cm dia.

**J0810fb Probe.** 2.0cm dia.

**J0810fc Probe.** 2.5cm dia.

**J0810fd Probe.** 3.0cm dia.

**J0810df Concave Closed Probe.** For large, raised lesions

**Mini Closed Probe.** Used to treat eyelid margin and corneal lesions. Gently curved to allow visualization and precise control.

**J0810ga Probe.** 1mm. **J0810gd Probe.** 4mm.

**J0810gb Probe.** 2mm. **J0810ge Probe.** 5mm.

**J0810gc Probe.** 3mm. **J0810gf Probe.** 6mm.

**J0810gg Rectangular Mini Closed Probe.** 1.5mm x 3mm.

**J0810gh Rectangular Mini Closed Probe.** 2.5mm x 5mm.

**J0810gL Neurectomy Probe.** Specially designed extension allows positioning of apertures at bottom of cryogun. This allows cryogun to be better positioned over treatment area (not pictured).

**J0810ra Malleable Extension.** Used with any spray tip or contact probe to change angle of spray while keeping unit upright.

**J0810rb Right Angle Adaptor.**



**Cryosurgery Accessory Items.**

**J0810j Back Vent Adaptor.** Eliminates intermittent spray and increases nitrogen flow when used with small contact probes and smaller apertures.

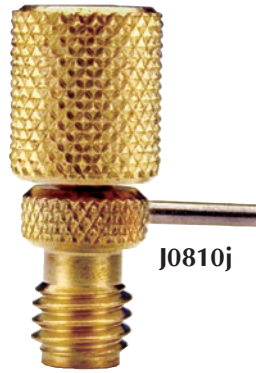

J0810j

**J0810m Cryoplate.** A transparent lexan plate with four various size conical openings. Used to concentrate spray within a limited area.



J0810m

**J0810n Cryocones.** A set of six neoprene cones that are used to concentrate or direct spray within a limited area.

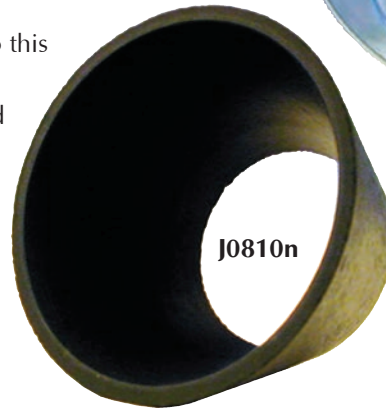

J0810n

**J0810t Cryotote.** Allows easy transport of cryogun with two pockets for probe storage. velcro closure.



J0810t

**J0810u Luer Lock Adaptor.** Adapt your own needles to this luer lock fitting.

**J0810z Ferret Adrenal Gland Probe.** Specially designed probe for freezing adrenal gland tumors in ferrets.

**J0811m Cryosurgery in Horses Handbook.**

**Storage Equipment.** New and improved Dewar allows for longer storage of liquid nitrogen—up to 300 days.

**J0811e 20-Liter Dewar.**

*NOTE: Other sizes of Dewars available.*

**J0811j Withdrawal Tube.** An inexpensive, simple, and efficient way to extract liquid nitrogen from Dewar storage to your cryogun.

*NOTE: Please supply manufacturer, model number, and capacity of Dewar when ordering.*



J0811e



J0811j



**J0823** **7-Day Pill Case.** Certain medications like thyroid, heart and epilepsy treatments need to be given every day to be effective. This pill case is a great aid for increasing owner compliance in administering medications. It is clearly labeled for "Pets Only," and shrink wrapped on an attractive display card.

**J0824** **Glass Eye Dropper** with black rubber bulb. Handy for giving medication orally or into eyes or ears. Especially for smaller pets or exotics. 1ml calibrated. 5/pk.

**J0824c** **Plastic Medicine Dropper** with blue rubber bulb. Graduated in milliliters and teaspoons. 2.5ml (1/2 tsp.) 5/pk.



J0823



J0824c



J0824

**Pet Nurser Kit.** This baby bottle is ideal for supplementing milk to newborn small pets. The clear silicone nipple is very long-lasting. The bottle has clearly marked measurements on its side. Also includes bottle cleaning brush and extra silicon nipple.

Packed on blister-pack display card with directions for use on back.

**J0787** **Bottle.** 50ml (1 2/3 oz.).

**J0787L** **Bottle.** Large. 150ml (6 oz.).

**Mothering Kit.** This unique kit features a tiny syringe gun with three interchangeable tiny clear silicone nipples. The concept is to draw milk up into the tiny syringe then attach a nipple. The milk is slowly administered as the newborn starts to suckle. Allowed the feeding of the smallest of animals.

Kit includes clear silicone nipples and syringe. Packaged on blister-pack display with directions for use on the back.

**J0788** **Complete Mothering Kit.**

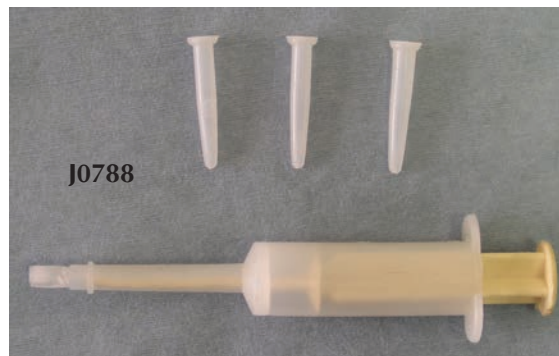

J0788



J0787



**J0384x Buster Pet Piller.** New and improved model.

- Finger rings for better control
- Soft rubber jaws to reduce the chance for injury and are more comfortable for the patient
- Can draw water into pet piller to aid swallowing
- Attractive display boxes hold 10 pet pillers
- Transparent barrel

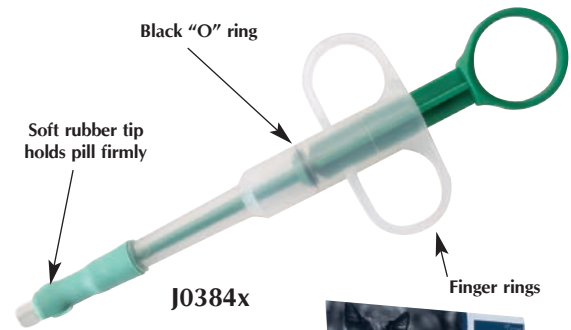
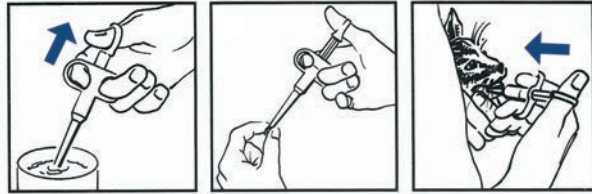

*NOTE: According to a published study done at the CSU veterinary hospital, cats that dry swallow tablets will have these tablets retained in the esophagus for up to several hours. Many tablets, i.e. doxycycline, are quite irritating. A small amount of water helps eliminate this relatively unknown problem.*

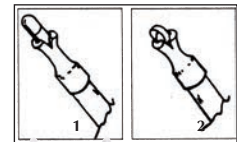

**Pet Piller.** Long plastic barrel with plastic plunger. Designed like a large animal balling gun. Administer tablets and capsules to pets more quickly, safely, and easily.

- Soft latex rubber tip
- Easy to clean
- Gentle to pet's mouth
- Correct size even for small pets

**J0384 Pet Piller.** Bulk, 12/bag.

**J0384s Pet Piller.** Individually shrink-wrapped for display. 12/pk.

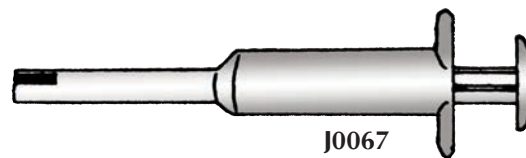

**J0067 Pet Pill Gun** used in administering pills to small animals. Unique feature allows a small amount of water to pass with the pill to facilitate swallowing. 12/pk.



**J0697 Pill Counting Tray.** Handy device for counting out pills for accurate prescription count. Plastic. 6"W x 8"L. Spatula is included.



**J0932 Mortar and Pestle.** The pharmacy aid for crushing tablets into fine powder. Fine quality porcelain mortar and pestle. Smooth surface with pouring lip. 4 oz.



**Pharmacy Folding Carton.** Inexpensive pill dispensing cartons. Heavy white paper board with marked "directions". 100/pk.

- J0933a** **Carton.** Small. 1<sup>1</sup>/<sub>4</sub>" x 2<sup>1</sup>/<sub>4</sub>" x 1<sup>5</sup>/<sub>16</sub>".
- J0933b** **Carton.** Medium. 2<sup>1</sup>/<sub>2</sub>" x 1<sup>1</sup>/<sub>2</sub>" x 3<sup>3</sup>/<sub>4</sub>".



**J0933**

- J0934** **Pill Envelope.** Heavy weight tan paper stock with gummed flaps. Imprinted with standard prescription to fill in. Convenient for small pill quantities. 3<sup>1</sup>/<sub>2</sub>" x 2<sup>1</sup>/<sub>4</sub>". 100/box.

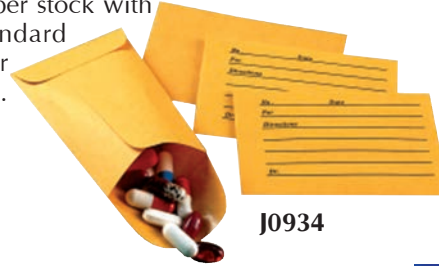

**J0934**

**StaySafe - Self-sealing bottle closures.** This patented product allows a luer slip syringe to repeatedly withdraw oral liquids from plastic amber pharmacy bottles. The Stay Safe is pressed into bottle opening.

StaySafe Closures feature flexible sealing rings for compatibility with a range of bottle sizes. Size 24 fits snugly into most bottles with necks in its I.D. (inner diameter) range of 15.5mm - 18.25mm.

Bottles should be selected for smooth inside necks sized with the stated inner diameter range. A smooth neck optimizes the ability of the closure to provide an effective seal.

- J1080** **StaySafe closures.** 24mm/50pk
- J1080a** **Seal Safe Closures.** 20mm/50pk
- J1080b** **Seal Safe Closures.** 28mm/50pk

**Suggested Bottle Neck Size ID**

	Min	Mid	Max
20mm	12.6	13.9	15.3
24mm	17.9	18.7	19.5
28mm	20.2	20.8	21.4



**J1080**

- J1117** **Seal Breaker/Cotton Puller.** A must for pharmacy departments, these aluminum foil seal breakers and cotton pullers make daily pharmacy tasks easier. The Seal Breaker contains a small single hook on one end and a full hook on the other end. Handle is easy to grip. 8" long.



**J1117**

- J1119** **Rx Vial Cap Opener.** Easily opens difficult Rx vial caps. EZ-grip soft handle.

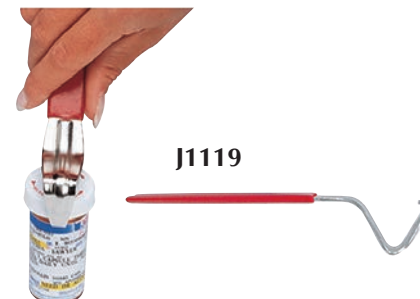

**J1119**

**J0613 Pill Crusher.** Many times a tablet or pill is too large for a pet to swallow. In addition, a pill can be crushed to hide in the animal's food or in a treat. This pill crusher works by dropping the pill into the clear chamber and screwing the top portion directly into it. It also has a handy storage area in the lid to keep extra tablets close by. Top and bottom have raised knurled ridges for easy tightening.

Made of high impact plastic. Packaged in blister pack display.

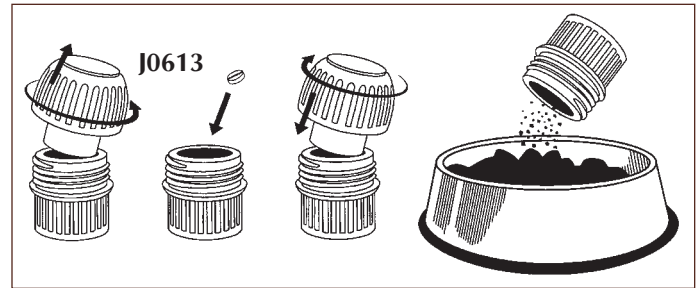

**J1118 12" Tweezers for cotton plugs.** These 12" tweezers make it easy to remove cotton or pills from deep bottles. Stainless steel.



**J0696 Pill Splitter.** Many tablets or pills are too large for smaller veterinary patients. There is a need to precisely split pills for accurate dosing. This pill splitter has a thin razor-sharp blade that cuts the pill cleanly. The "V"-shaped trough holds a variety of pill sizes. Lightweight blue plastic can be easily cleaned.

**J0696d Deluxe Clear Pill Splitter.** An improved pill splitter for more precise and cleaner cuts. Additionally, larger non-standardized pills fit.

- Flexible arms and cutting base with soft rubber material that holds pills more securely in place
- See through design assists user to visually align pill prior to splitting
- Molded polycarbonate with double-beveled German-made steel blade



**J0698 Combo Pill Splitter/Crusher.** This handy device will either split or crush a tablet. It also has a storage case on the bottom. Blue.





**Foot Operated Dispenser** for antimicrobial soaps and solutions. Hand-operated soap dispensers are potential sources of microbial contamination and resultant spread of infection. To assure protection for the surgeon and the patient avoid all possible contact with material other than the microbial solution when hand washing.

If serious about presurgery scrub, you need this dispenser.

The system has a metering valve that dispenses the same 2cc of solution each and every time, regardless of the solution level. Moreover, the valve diaphragm ensures that contaminated pressurized air from the foot pedal never contacts the solution. Will work with any solution that is safe to use on your hands.

**J0839 Foot Operated Dispenser with Foot Pump.** Blue. Remove cover to refill, capacity 28 fluid oz. (828 ml). Includes wall bracket mount for easy detachment and cleaning. Complete with 6' (2 meter) medical grade PVC tubing.

*NOTE: Spare parts available.*



Footpedal for J0839

**Alcohol Dispenser.** This handy pump bottle dispenses alcohol by pressing down on the top lid. Great for use in the exam room for alcohol wipes pre-injection in vaccinations. 8 oz. amber polypropylene bottle.

**J0614 Alcohol Dispenser.** Amber plastic.

**J0614g Alcohol Dispenser Bottle.** Amber glass.



J0619c

**J0619c Colored Animal Labeled Sundry Jars.** Front panel labels with funny cartoons. Opaque bases. 5/Set. 4" dia. x 6 1/2"H. Acrylic.

**J0619 Sundry Jars.** Features clear tops and bases. 4 3/4" dia. x 6 1/2"H. 5/Set. Acrylic. (Wall rack not included.)

**J0619r Plexiglass Wall Rack.** For J-619.



J0619 & J0619r

**J0619g Glass Sundry Jars.** The standard for every exam or treatment area. Set of five. Labeled: Applicators, Bandages, Cotton, Tongue Depressors, and Gauze.



J0619h-m

**J0619x Set of five unlabeled plain glass jars.**

**J0619h Applicator. Glass jar only.**

**J0619j Bandages. Glass jar only.**

**J0619k Cotton. Glass jar only.**

**J0619m Tongue Depressors. Glass jar only.**

**J0619n Gauze. Glass jar only.**



**NEW**

## Count Right Pill Counter



**Count Right Pill Counter.** Counting pills is an arduous task at every clinic. It is a time consuming and expensive job that no one wants. Other electronic pill counters are fast, accurate and convenient, but cost thousands of dollars.

The **JorVet Count-Right Pill Counter** is a simple design at a moderate price.

- Counts all size pills and capsules except for extra-large 'horse' tablets.
- Slides or rests on top of standard plastic pill counter (included - figure 4)
- 9 volt DC battery lasts for months (included)
- Simple on/off switch that shuts off automatically after 15 seconds of non-use
- Pill chute: pour in pills slowly and evenly across the top of the pill chute (figure 2)
- After desired count, gently lift off Count-Right pill counter and pour pills into a prescription vial from pill tray (figure 3)
- Easy and simple to learn how to use

Dimensions:

4<sup>1</sup>/<sub>2</sub>"W x 4<sup>1</sup>/<sub>2</sub>"L x 4<sup>1</sup>/<sub>2</sub>" H without tray

Weight: 11 oz (330 grams) without tray

Warranty: Two years on manufacturer defects

**J1245      Count Right Pill Counter.**

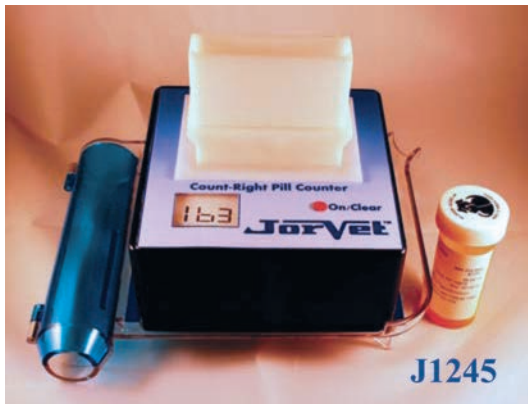

**Boston Round Bottles with Yorker Caps.** Excellent for dispensing solutions. Opaque color. Screw on tops with red caps. Available in small lots or bulk.

- J1204a Round Bottle.** 0.5oz (15ml). 25/pk
- J1204ab Round Bottle.** 0.5oz (15ml). 100/pk
- J1204b Round Bottle.** 1.0oz (30ml). 25/pk
- J1204bb Round Bottle.** 1.0oz (30ml). 100/pk
- J1204c Round Bottle.** 2.0oz (60ml). 25/pk
- J1204cb Round Bottle.** 2.0oz (60ml). 100/pk
- J1204d Round Bottle.** 4.0oz (120ml). 25/pk
- J1204db Round Bottle.** 4.0oz (120ml). 100/pk
- J1204e Round Bottle.** 6.0oz (180ml). 25/pk
- J1204eb Round Bottle.** 6.0oz (180ml). 100/pk
- J1204f Round Bottle.** 8.0oz (240ml). 25/pk
- J1204fb Round Bottle.** 8.0oz (240ml). 100/pk
- J1204h Round Bottle.** 16.0oz (360ml). 25/pk
- J1204hb Round Bottle.** 16.0oz (360ml). 100/pk



J1204 - 1 ounce

**Amber Dropper Bottle.** Plastic with screw cap. Labeled with oz and ml on the bottle and dropper. Available in small lots or bulk.

- J1205a Dropper Bottle.** 0.5oz (15ml). 12/pk
- J1205ab Dropper Bottle.** 0.5oz (15ml). 72/pk
- J1205b Dropper Bottle.** 1.0oz (30ml). 12/pk
- J1205bb Dropper Bottle.** 1.0oz (30ml). 72/pk
- J1205c Dropper Bottle.** 2.0oz (60ml). 12/pk
- J1205cb Dropper Bottle.** 2.0oz (60ml). 72/pk



J1205

**Ointment Jar.** White plastic with snap-on lid. 12/pk

- J1206a Ointment Jar.** 1.0oz (30ml)
- J1206b Ointment Jar.** 2.0oz (60ml)
- J1206c Ointment Jar.** 4.0oz (120ml)
- J1206d Ointment Jar.** 8.0oz (240ml)
- J1206e Ointment Jar.** 16.0oz (480ml)



J1206



**Small volume liquid dropper bottle.** These small volume dropper bottles are perfect for smaller pets or medications such as ophthalmics. Also available in sterile packs

- Bottle and cap made of slightly opaque, low density polyethylene
- White cap made of polystyrene
- Small drop volume inner nozzle

<b>J1209</b>	3ml (0.1oz) bottle and cap	12/bag
<b>J1209a</b>	7ml (0.25oz) bottle and cap	12/bag
<b>J1209b</b>	15ml (0.5oz) bottle and cap	12/bag
<b>J1209c</b>	30ml (1.0oz) bottle and cap	12/bag

Sterile. 2 bottles per ETO sterilized pouch, 6 pouches per bag for a total of 12.

<b>J1209s</b>	3ml sterile
<b>J1209as</b>	7ml sterile
<b>J1209bs</b>	15ml sterile
<b>J1209cs</b>	30ml sterile



**Amber Plastic Graduated Ovals.** Amber plastic graduated ovals with twist off child resistant caps. Lightweight and transparent. Graduated in mls

<b>J1207a</b>	2oz	50/box
<b>J1207ab</b>	2oz	200/case
<b>J1207b</b>	4oz	50/box
<b>J1207bb</b>	4oz	200/case
<b>J1207c</b>	6oz	25/box
<b>J1207cb</b>	6oz	100/case
<b>J1207d</b>	8oz	25/box
<b>J1207db</b>	8oz	100/case
<b>J1207e</b>	12oz	25/box
<b>J1207eb</b>	12oz	100/case
<b>J1207f</b>	16oz	50/case



**Glass Amber Dropper Bottle with Glass Dropper/Pipette.** Some medications interact with plastic bottles and plastic droppers. So a total glass product is preferred.

<b>J1208</b>	0.5oz (15ml)	12/box
<b>J1208a</b>	1.0oz (30ml)	12/box
<b>J1208b</b>	2.0oz (60ml)	12/box



**Evan's Mobility Cart.** Veterinarians frequently encounter patients that are non-ambulatory, either temporarily or even permanently. Providing these patients with the proper support is a difficult challenge, yet necessary to get the patient up and moving to achieve maximum rehabilitation.

The Evan's mobility cart was designed by a veterinarian to help any animal that is "down" on hind or front limbs due to post surgery or trauma, paralysis, hip dysplasia or other arthritic conditions.

The cart features:

- Tough, durable framework constructed of powder coated lightweight tubular steel
- Four legs with casters with bearings, allowing 360° range of motion
- Reduced risk of cart turnover
- Washable and adjustable nylon mesh saddle support

- J0865 Small Mobility Cart.** 10"W x 14<sup>1</sup>/<sub>2</sub>"L x 14<sup>1</sup>/<sub>2</sub>"H. 11" maximum shoulder length. Dachshund/small terrier.
- J0865a Medium Mobility Cart.** 14<sup>3</sup>/<sub>4</sub>"W x 18<sup>1</sup>/<sub>2</sub>"L x 20<sup>1</sup>/<sub>4</sub>"H. 16" maximum shoulder length. Beagle/Cocker Spaniel.
- J0865b Large Mobility Cart.** 18<sup>3</sup>/<sub>4</sub>"W x 25<sup>1</sup>/<sub>2</sub>"L x 26"H. 22" maximum shoulder length. Airedale/Chow.
- J0865c X-Large Mobility Cart.** 24<sup>3</sup>/<sub>8</sub>"W x 32<sup>1</sup>/<sub>2</sub>"L x 33<sup>3</sup>/<sub>4</sub>"H. 29" maximum shoulder length. Rottweiler/Labrador.



**Web Master Harness.** The safe use of hydrotherapy should include either a float coat or, for advanced swimmers, a safety harness. No patient should be swimming with just a single collar. The Web master Harness has a three point system with a "D" ring. The lifting handle is low profile with a quick release snap. the harness is made of heavy-duty nylon material for durability.

A secure but comfortable harness designed especially for hydrotherapy.

Color is red and black

	Size	Primary Measurement	Dog Length
<b>J0979a</b>	<b>XXS</b>	12" – 19"	10"
<b>J0979b</b>	<b>XS</b>	17" – 24"	12 <sup>3</sup> / <sub>4</sub> "
<b>J0979c</b>	<b>S</b>	18" – 30"	15 <sup>1</sup> / <sub>2</sub> "
<b>J0979d</b>	<b>M</b>	23" – 36"	19"



**Doggie Diaper Wraps.** These two wraps were designed for use in two areas.

- Patients with fecal incontinence due to illness or age
- Patients undergoing rehab in underwater treadmills or hydrotherapy
- A more professional product that “pet stores” diapers



**Rehab Doggie Diaper Wraps.** Suggested for male & female patients that are experiencing fecal incontinence. They are designed with a unique (patent pending) cord-lock system to trap most feces and urine from escaping onto the floor and furniture.

- Manufactured with 3 layers of material, the outside layer is a poly/cotton fabric
- Middle layer is a vinyl plastic and elastic that helps trap feces/urine from escaping
- Velcro straps and elastic aid in making sizing adjustments and patient comfort
- Tail hole has hourglass design with drawstring to make comfortable seal in patients with large tails
- Attractive gold paw print

- J1130a Small** 8–14lbs
- J1130b Medium** 15–27lbs
- J1130c Large** 28–50lbs
- J1130d XL** 51–75lbs
- J1130s Set of 4 sizes**



**J1130p Disposable insert pads** (12pk)

Your clients will appreciate this product!!

**Swimwear Doggie Diaper Wraps.** The swimwear prevents fecal material from entering into treadmills or hydrotherapy pools. Not every patient using a treadmill needs one, but many do. Expensive draining and cleaning of these systems is best avoided.

- Unisex
- Tail vent and lock system
- Designed to get wet
- Machine washable
- Solid black color

- J1131a small**
- J1131b medium**
- J1131c large**
- J1131d x-large**
- J1131s set of all four**



**Bottom's Up Harness™.** This award-winning rear-end dog harness helps your dysplastic, arthritic, post-surgical, or otherwise disabled dog move more comfortably and safely. No more cumbersome towels under their bellies! A slight lift on the leash controls the amount of weight being placed on the dog's hind legs. Using rebalanced body weight as leverage, the leash allows smaller owners to easily mobilize and stabilize larger dogs.

- Therapeutic—dogs heal faster by getting them up and mobile
- Facilitates a dog's need to regain its dignity through walking and eliminating naturally
- Enables disabled dogs to walk by shifting their weight to their healthier front legs
- Comfortable and safe—100% nylon
- Hygienic—leash is washable with soap and water
- Recognized—2004 Dog Fancy Magazine Editors' Choice
- Universal—one size fits almost all dogs
- Weight—7 ounces
- Patent #6,729,268



Used by many vet schools

**J1104 Bottom's Up Harness**



**Thera-Paw.** Padded and supportive boots for painful or injured paws provides superior protection against environmental hazards. Recommended uses include: paw and bandage protection after surgery; management of cuts, burns, torn tendons and ligaments; ideal for hydro-therapy and rehabilitation; excellent traction for unstable dogs.

Features include:

- Ultra-cushioned interior padded base
- Rubberized, waterproof, tractioned sole
- Breathable Airprene sock/sleeve
- Double-closing Velcro lapels for additional security
- Seamless interior
- Quick drying and easy maintenance



**THERA-PAW**

	Size	Paw Length	Paw Width	Weight	Wrist/Ankle Circumference	Wrist/Ankle Height
J0864a	sm	2 1/2"	2"	15-35 lbs.	Up to 3 1/2"	2 1/4"
J0864b	med	3 1/2"	2 3/4"	60-90 lbs.	Up to 5"	3"
J0864c	lg	4 1/4"	3 1/2"	100-130 lbs.	Up to 6 1/2"	4 1/4"
J0864ab	sm/med #1	2 3/4"	2 1/4"	30-50 lbs.	Up to 4"	2 3/4"
J0864abb	sm/med #2	3"	2 1/2"	40-70 lbs.	Up to 4 1/2"	3"
J0864bc	med lg	3 3/4"	3"	80-110 lbs.	Up to 5 1/2"	3 3/4"

Please refer to our website [www.jorvet.com](http://www.jorvet.com) for proper sizing measurements.



Eva is a nautical search and rescue dog with the Italian Coast Guard, owned by Roberto Gasbarri.



Xena is a retired New Jersey State Police Dog, owned by SFC Debra Faiello. Her work included explosive detection, search and rescue, and tracking.

**BUSTER**

**BUSTER Dog Socks.** The sock is used as a cover for paw-bandages. It is made of rib-knitted cotton with a hard-wearing and waterproof sole so the bandage can "breathe." The sock is pulled tight upwards and fastened with 2 pieces of plain adhesive tape. Available in three sizes:

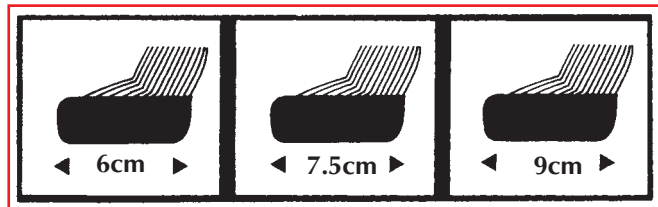

J0113a Small. J0113b Medium. J0113c Large.



**CARPAL WRAPS:** Jorvet carries 3 carpal support products that vary in the degree of support that they provide.

**Degree of Support Scale (1-10):** 1 (provides light support) – 10 (provides complete immobilization)

**1) Carpo-Flex Sports Wrap:** Provides light support and protection (Scale: 1 – 3). Ideal for mild strains and sprains or arthritis.

- J1004 XS right** Teal. 5"W x 3.5"H; 1.0mm neoprene; 1"W elastic straps
- J1004L XS left** (fits small dogs with up to 4.5" wrist circumference)
- J1004a S right** Red. 6"W x 5"H; 1.5mm neoprene; 1"W and 1.5"W elastic straps
- J1004aL S left** (fits small to medium dogs with up to 5.5" wrist circumference)
- J1004b M right** Blue. 7"W x 6"H; 1.5mm neoprene; 1.5"W elastic straps
- J1004bL M left** (fits medium dogs with up to 6.5" wrist circumference)
- J1004c L right** Black. 8"W x 6.75"H; 2.0mm neoprene; 2"W elastic straps
- J1004cL L left** (fits large dogs with up to 7.5" wrist circumference)



**2) Carpo-Flex-X:** Provides moderate support (Scale: 4 – 7). Nylon support straps can be Velcroed on any aspect of the wrap for customized support of the medial, lateral, and/or caudal aspect of the limb.

- J1004e XS right**
- J1004eL XS left**
- J1004f S right**
- J1004fL S left**
- J1004g M right**
- J1004gL M left**
- J1004h L right**
- J1004hL L left**
- J1004j L right**
- J1004jL L left**

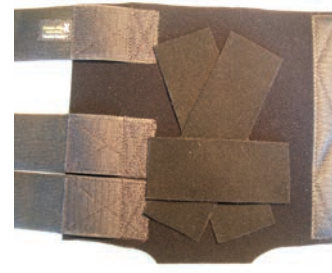

Carpo-X plus nylon



**3) Carpo-Splint Kit:** Provides heavy support to complete immobilization (Scale: 8 – 10). Thermoplastic sheet can be molded over any aspect of the wrap to produce a custom immobilizing splint. The Kit includes 1 thick, neoprene wrap, foam padding, nylon straps, thermoplastic sheet, and Velcro tabs.

- J1004m XS right**
- J1004mL XS left**
- J1004n S right**
- J1004nL S left**
- J1004p M right**
- J1004pL M left**
- J1004q L right**
- J1004qL L left**
- J1004r XL right**
- J1004rL XL left**
- J1004s Set of 8 sizes**

*NOTE: Due to risk of infection, all splints should be applied only on limbs of animals with protective covering. We will dispose of any splint returned containing animal hair.*



Carpo-flex splint kit, complete



Carpo-flex with splint

Comprehensive directions are included with each of the carpal wraps.



Medial splint mold



Lateral splint mold



Palmar splint mold



**Dorsi-Flex Assist.** Provides light to moderate assistance for normal hind paw placement. Designed for use as a therapy aid or for daily activity. (Not to be used for dogs with severe neurological impairments.)

Uses:

- Reduces knuckling/standing on the dorsum of the paw
- Mobility aid for unstable or weak distal hind legs
- Assists with tarsal/hock flexion and digital extension
- Can be used bilaterally

Features:

- Adjustable, elastic tension straps
- Includes breathable, anti-skid, Thera-Paw boot
- Will not immobilize joints
- Lightweight
- Easy to put on/take off
- Cleans easily by rinsing with warm water



**J1005ba Tiny.** Includes Thera-Paw size S (paw 2"W x 2.5"L) and tibial cuff up to 2.75" circumference.

**J1005aa XXS.** Includes Thera-Paw size S/M (paw 2.25"W x 2.75"L) and Tibial cuff up to 3.5" circumference.

**J1005 XS.** Includes Thera-Paw size S/M #2 (paw 2.5"W x 3"L) and Tibial cuff up to 4.5" circumference

**J1005a S.** Includes Thera-Paw size M (paw 2.75"W x 3.5"L) and Tibial cuff up to 5.5" circumference

**J1005b M.** Includes Thera-Paw size M/L #2 (paw 3"W x 3.75"L) and Tibial cuff up to 6.5" circumference

**J1005c L.** Includes Thera-Paw size L (paw 3.5"W x 4.25"L) and Tibial cuff up to 8" circumference

*NOTE: Due to risk of infection, all splints should be applied only on limbs of animals with protective covering. We will not accept any splint returned containing animal hair.*

**Canine Icers™ Stifle Joint.** The use of cold or ice packs over recent surgical sites, or also for chronic joint pain is well accepted modality. Getting a consistent and even application on a canine patient is the challenge. Canine Icers™ are made of strong and insulating neoprene with soft interior pockets of lycra. Quick release straps allow for maximum adjustability.

		Length from hock to mid-thigh
<b>J0342a</b>	<b>Small</b>	5 – 7"
<b>J0342b</b>	<b>Medium</b>	7 1/4 – 9"
<b>J0342c</b>	<b>Large</b>	9 1/4 – 11"
<b>J0342d</b>	<b>Extra Large</b>	11"+





**Tarso-Flex Kit.** Tarso-FlexX is a versatile tarsal wrap that can be modified to provide customized fit and support for the pet. This versatile tarsal wrap can be customized for a variety of tarsal conditions including but not limited to Achilles tendon injuries, MCL injuries, tarsal luxation, hyperextension, arthritis and DJD, and post-cast/splint removal. In addition, a thermoplastic splint (Marq-Easy sold separately) can be molded on any aspect of the outside of the wrap (medial, lateral, caudal, cranial) to provide immobilization.

		A Measurement: Cranial Height from tarsal joint to below tibial crest	B Measurement: Cranial height from dorsal paw to tarsal joint	C Measurement: Circumference at tarsal joint
J1106a	Small	3.25" – 4.5"	2.5" – 3.5"	5" – 6"
J1106b	Medium	4.25" – 5.5"	4" – 5.5"	6" – 7.5"
J1106c	Large	5.75" – 7"	4.5" – 6"	8" – 10"

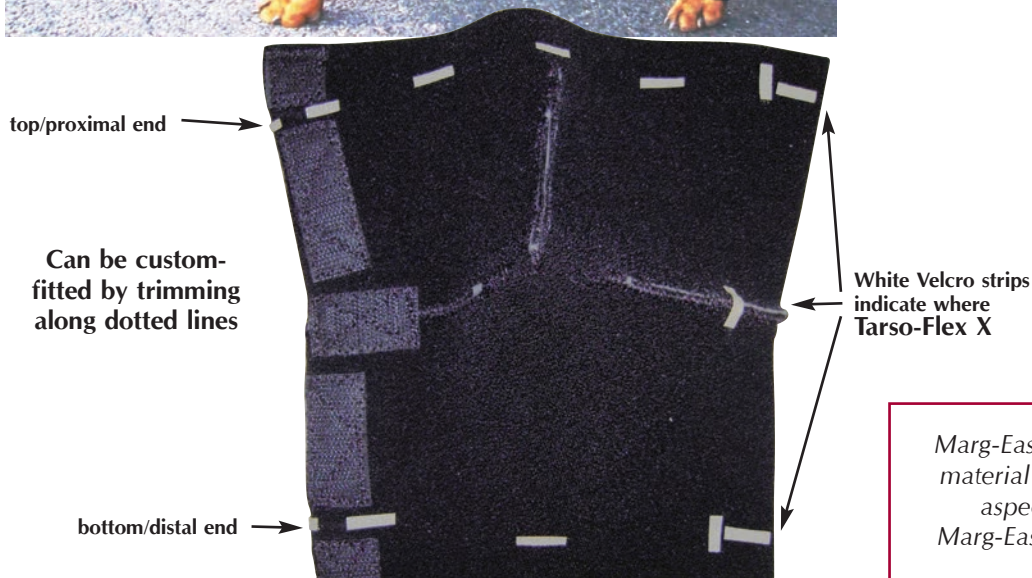
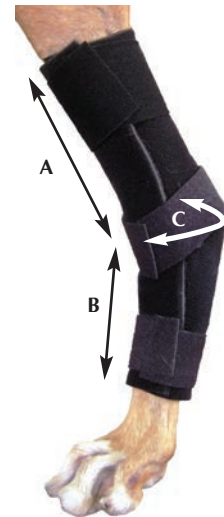

Marg-Easy Thermoplastic splinting material can be molded over any aspect of the Tarso-Flex-X. Marg-Easy sold separately (J0940)



**The Walkabout™ Harness.** The options for a paralyzed dog or cat are limited. Their quality of life depends upon the owner's ability to deal effectively with their situation. Euthanasia often is chosen. Today's pet owner wants other choices, and the Walkabout™ provides the alternative.

The design and construction of the Walkabout™ harness provides the balance and support necessary for your pet to lead a happier, healthier and cleaner life. Use of the Walkabout™ also can help minimize the owner's back strain that can result from lifting and carrying the pet.

Used by over 20 veterinary teaching institutions, plus the Animal Medical Center in New York and the Research Center for Paralysis at Purdue University.

- **Front Harness:** A smooth, semicircular neckline allows your pet to breathe comfortably, while simultaneously supporting his/her front end.
- **Combination Harness:** Double harnessing may provide the safest and most comfortable means to transport your pet. Measurements are necessary for both front and back. **Special Order.**
- **Amputee Harness:** A custom design provides a harness for pets who have lost a limb. **Special Order.**

*NOTE: Specify legs remaining and their measurements.*

**Rear Harness.**

Measure hindquarter according to graphic to the right.

		A	B
J0456a	X-Small.	9"–15"	3"–6"
J0456b	Small.	10"–16"	3"–8"
J0456c	Medium.	15"–21"	6"–12"
J0456d	Medium-Large.	20"–29"	11"–15"
J0456e	Large.	24"–31"	14"–17"
J0456f	X-Large.	31"–35"	16"–19"
J0456s	Set of 6.		

**Front Harness.**

Measure forequarter according to graphic to the right.

		C	D
J0456af	X-Small.	9"–15"	3"–6"
J0456bf	Small.	10"–16"	3"–8"
J0456cf	Medium.	15"–21"	6"–12"
J0456df	Medium-Large.	20"–29"	11"–15"
J0456ef	Large.	24"–31"	14"–17"
J0456ff	X-Large.	31"–35"	16"–19"
J0456sf	Set of 6.		

**EZ Lift Harness.** A simple device to aid in rehabilitation or physical therapy. Any back surgery or hind limb weakness will be helped along with the use of this device. Straps can be adjusted with double-bar buckles. Washable nylon cloth.

- J0743 **EZ Lift Harness.** Small. 5½" W –14" L
- J0743a **EZ Lift Harness.** Large. 7½" W –26" L
- J0743s **Set of 2 EZ Lift Harnesses.** Small and Large.



Adjustable Quick Release Snap For a Comfortable Fit  
Neoprene Material, Washable & Will Stretch

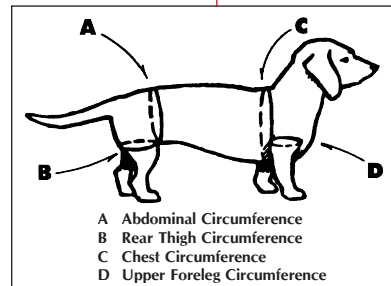
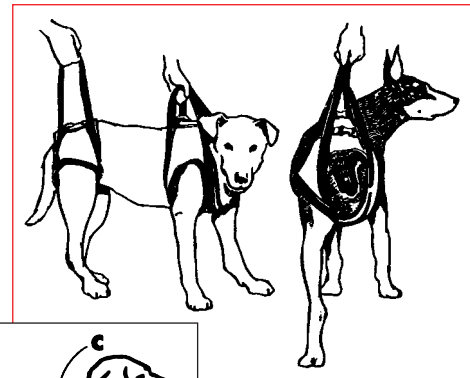
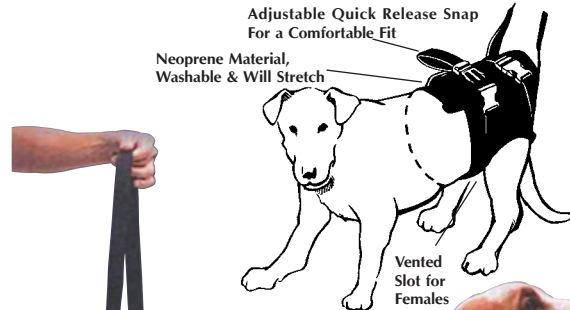



## MB Spinal Brace

Many cases of disc disease, spinal fractures or instabilities are not amenable to surgical treatment for a variety of reasons, from the right patient signalment (i.e. age, underlying diseases) to economic considerations. The "MB Spinal Brace" (MBSB) is designed to help support cases of cervical, thoracic and lumbar IVDD, vertebral fractures or instabilities. The durable and comfortable neoprene harnesses encircle the patient at the desired locations and are connected by two parallel adjustable metal rods that lay on the lateral aspects of the chest, abdomen or neck depending on particular area being treated. The MBSB supports and restricts the range of motion of the patient in several planes giving the body a better chance of healing. The expandable metal connection rods can be placed in a neutral position strictly for support, or extended to apply minimal to moderate decompressive forces on the spine. These back braces are commonly used in the human medical field and now they are available for veterinary use.

Several indications for use include:

- Medical IVDD treatment (support and decompression)
- Medical spinal fracture treatment
- Medical spinal instability treatment (i.e. Wobblers)
- Pre and post-surgical spine support

Additional features:

- High quality neoprene construct allows for patient comfort while not compromising strength and durability
- Interchangeable and adjustable metal connection rods allow for use with a wide range of patients.
- Easy to apply and remove for physical therapy, to allow patients to urinate, or for owners to use at home.
- Affordable alternative for owners to allow for long-term home spine management. To select the proper MBSB: Obtain the circumference (A and C) and the length (B) measurements for the desired spine segment from your patient. (See diagram below right.)

**Introductory Kits:** The best way to have the braces on hand for that immediate or emergency case. The sets come with a range of harnesses plus one set of connecting rods.

**J1243a Small Intro Kit** for toy breeds and Chihuahuas includes: 4 neoprene harnesses, 12" – 18" and 1 pair of connecting rods <sup>5</sup>/<sub>16</sub>"

**J1243b Medium Intro Kit** for Dachshunds, Shih-Tzus, Miniature Schnauzers, Pugs, and Terriers includes: 5 neoprene harnesses, 18" – 30" and 1 pair of connecting rods <sup>3</sup>/<sub>8</sub>"

**J1243c Large Intro Kit** for Boxers, Labs, Huskies, Shepherds, and Bassett Hounds includes: 6 neoprene harnesses, 28" – 38" and 1 pair of connecting rods <sup>1</sup>/<sub>2</sub>"

**Individual Braces:** A complete brace requires 2 neoprene harnesses (sold individually) and 2 metal connecting rods (sold as a pair). Brace sizes are color coded based on the metal connecting rod used. Complete Start-up Kits are recommended as initial stocking purchase to allow for complete size availability. Replace individual components as needed.

### MB Spinal Brace Neoprene Support Harness

Code	Length (B)	Circumference (A, C)	
J1240a	3"–5"	a	7" – 9"
J1240b	5"–7"	b	9" – 11"
J1240c	7"–10"	c	11" – 13"
J1240d	10"–12"	d	13" – 15"
J1240e	10"–16"	e	15" – 17"
J1240f	15"–21"	f	17" – 19"
J1240g		g	19" – 21"
		h	21" – 23"
		j	23" – 25"

A complete brace requires 2 neoprene harnesses

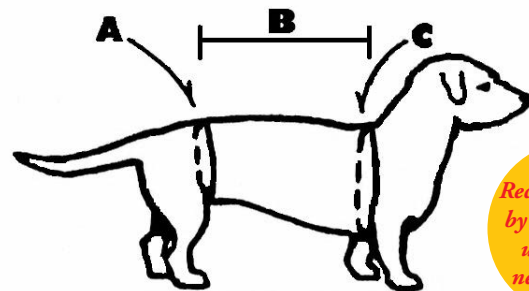
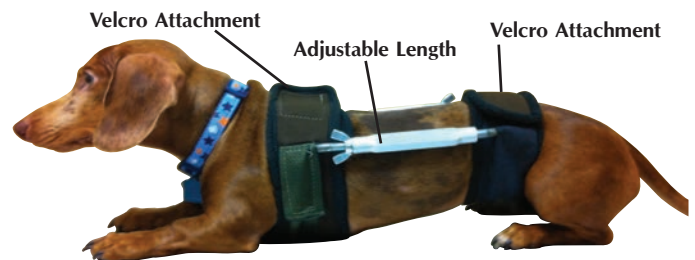

**Thoraco-Lumbar Brace Measurements**  
A - Abdominal Circumference  
B - Distance Between Hip and Shoulder  
C - Chest Circumference

Recommended  
by veterinary  
university  
neurologists

**Complete brace packages** are available for your convenience, or items can be purchased individually if additional or replacement parts are needed. Instructional handouts and an instructional DVD video come with the purchase of a complete brace package. Patent Pending. Ordering:

1. Chose brace back length
2. Then chose letter for abdominal "A" in diagram.
3. Then chose letter for chest "C".

MBSB Selection Guide:

1. Back Length (B): \_\_\_\_\_ Jorvet Code: \_\_\_\_\_
2. Abdominal Circumference (A): \_\_\_\_\_ Jorvet Code: \_\_\_\_\_  
(add A)
3. Chest Circumference (C): \_\_\_\_\_ Jorvet Code: \_\_\_\_\_  
(add C)



**JorVet introduces** a number of pieces of equipment that any clinic doing rehab will find useful. Some are high tech and some are pretty basic.

**J0752p Goniometer plastic 360°.** The goniometer can be used for the calculation of tibial plateau angles, wedge resections, angles of anteversion plus others. It also can be used to measure pre- and post-op range of motion to evaluate post-op physiotherapy. White background assures ease of seeing number on any color dog. Medium for dogs over 60lbs. 6" (15 cm).

**J0752m Goniometer.** Small for dogs under 10 lbs

**J0752n Goniometer** Medium. (16 – 60 lbs)

**J0752q Goniometer** Large. (60+ lbs)

**J0752t Gulick rehab tape measure.** Measuring for atrophy over muscle groups is an important bench mark in rehab. The Gulick rehab tape removes the subjectivity of wrapping a measuring tape around a leg. The spring loaded bead in the head of the tape shows when the precise 4oz tension is exerted. This eliminates differences between different people taking measurements over time and results in increased accuracy.

**J0752k Rehab outcomes measurement kit.** Consists of:

- J-752t Gulick rehab tape measure**
- J-752n "Finger" goniometer.** 21-60 lbs.
- J-752m Goniometer, small.** 1-20 lbs.
- J-752q Goniometer, large.** 60+ lbs.
- J-894 Rubber reflex mallet**

**J752s Small portable E-stim unit.** Complete with leads and pads. Batteries included. Two channels. Adjustable pulse width and frequency. Three stimulation modes constant, alternating, and synchronous On/Off settings. Ramp time setting. Affordable unit that is perfect for dispensing to clients for home care.

**J0752sd1 Carbon pads for E-stim units.** These carbon pads are reusable e-stim pads versus disposable adhesive pads. They are either taped or held in place. 2 per pack. Red.



J0752p



J0752q

J0752p

J0752n

J0752m



J0752t

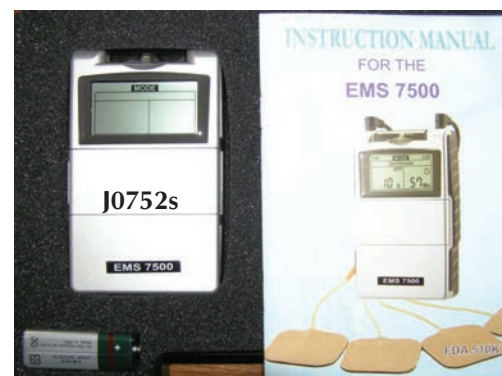

**FitPAWS® Balance Pad.** The FitPAWS® Balance Pad makes a perfect beginning balance training tool and provides low balance challenges for dogs recovering from injury. The closed-cell foam construction makes the FitPAWS Balance Pad impervious to water—great for when you need to hose it off between uses or use during under-water therapy. You can create varying degrees of balance challenge by stacking two or more balance pads on top of one another or can customize for use with larger dogs by using two balance pads side-by-side.



**J1129** 15" x 18.25" x 2" Blue



**Get on the Ball Two DVD.** Many dogs are lacking strength in their core muscle group: the lower back and abdominals. Working your dog on a Peanut or Egg Ball is an excellent and safe way to develop these muscles, which will aid in the reduction and prevention of problems. The Get on the Ball Two DVD provides four easy-to-follow programs: puppy, beginner, intermediate, and advanced. The DVD also includes an actual seminar held for ball work novices. Developed by Debbie Gross Saunders, a licensed physical therapist and a certified canine rehabilitation practitioner with over 15 years experience in the field. Running time: 3 hours, 3 disc set.

**J1126v**



**FitDogs® Pilates for Pooches DVD.** Pilates for Pooches DVD will teach your dog to move from its core while actively stretching its muscles by using various balance discs and pads. Sarah Johnson, M.A., Exercise Physiologist, presents a combination of lecture, outline and demonstration videos to guide you through this core strengthening and conditioning program step-by-step. Includes puppy bonus section and printable PDF documents summarizing conditioning guidelines, exercise outlines, and a log for monitoring your dog's progress. Running time: 64 minutes.

**J1127v**



**Osteoarthritis and Your Dog DVD.** This DVD presents information in lay terms, designed to help you understand the disease and your options for a multimode treatment program, and will show you things to do to help your dog lead a healthier, happier life! It shows how to use conditioning equipment like the Donut, Egg, balance discs, balance pads and rocker board. Running time: 1 hour, 22 minutes.

**J1128v**

**FitPAWS® Giant Rocker Board.** Finally, a Giant Rocker Board designed specifically for dogs! The FitPAWS Giant Rocker Board has an extra-wide training surface 30" x 30" (75cm x 75cm) and a 1.5" (4cm) center fulcrum bar. Depending on how your dog is facing, the board will rock from side-to-side or front-to-front. Use this canine conditioning tool for rehab, balance training, and beginner seesaw and contact training for agility.



- Padded, non-slip textured training surface
- Padding on edges of board to muffle sound when in use on indoor flooring
- Easy-to-clean. Surface mat is attached w/Velcro and is easily removed for cleaning. Hang up mat and spray with water. Allow to dry completely before replacing.
- Easy to maintain. Replacement FitPAWS Mats are available for purchase.
- Includes insert with exercise examples.

**J1127** 30" x 30" (75cm x 75cm) Giant Rocker Board  
**J1127m** 24" x 60" (61cm x 152cm) Replacement Mat

**FitPAWS® Hurdle Set.** An incredible value for the backyard agility enthusiast, traveling animal rehab practitioner or professional dog trainer. Completely adjustable and portable dog agility cone and hurdle set includes four 40" (102cm) jumping bars, eight highly-visible orange hurdle cones, eight height-adjustable attachments and a black nylon carrying bag.



- Use indoors or outdoors
- Height of jumping bar adjusts in 2" (5cm) increments from 2" to 30" (5cm-76cm)
- Perfect for easy rehabilitation or more challenging agility training
- Lightweight for on-the-go portability
- Some assembly required

**J1126** Hurdle and Cone Set





**JorVet introduces FitPAWS® Canine Conditioning Equipment.** FitPAWS® Canine Conditioning Equipment is used by animal rehabilitation professionals and veterinarians for core strengthening, increased range of motion and flexibility, neuromuscular facilitation, sensory and perceptual stimulation, joint alignment, and balance control. Helping your dog develop strong core muscles can reduce and prevent injuries.

Core conditioning is an essential part of any athletes training program, including the performance dog. Once on top of the FitPAWS conditioning equipment, your dog's body will automatically react to the shifting movement, causing your dog to use different muscle groups simultaneously in order to remain upright. Adding this strengthening activity to your dog's cross-training activities 3-4 times a week, has many benefits, including:

- Improved reaction and control
- Increased trunk and core strength
- Stabilization of weak areas
- Improved balance and proprioception (awareness of the body's position in space)
- Increased range of motion in joints and elongation of the muscles
- Improved sensory and body awareness



**FitPAWS® Peanut.** The FitPAWS® Peanut is a peanut-shaped stability ball designed for canine core conditioning and rehabilitation. The professional-grade heavy-duty PVC material is formulated for use with dogs, provides superior gripping and resists damage caused by dog nails. It is used for core strengthening of sporting and working dogs as well as for animal rehabilitation and therapy. The unique shape of the peanut limits its movement to front/back or side/side, important for dogs new to this type of training. You can also adjust the balance challenge by under-inflating so the ball is not as firm. Easily inflates with hand-held air pump, sold separately.



<b>J1126e</b>	80cm/31.5"	Red
<b>J1126d</b>	70cm/27.5"	Yellow
<b>J1126c</b>	60cm/23.5"	Blue
<b>J1126b</b>	50cm/19.5"	Red
<b>J1126a</b>	40cm/15.5"	Yellow

**FitPAWS® Egg.** The FitPAWS® Egg is a new shape of stability ball for the advanced canine athlete! It has a greater balance challenge due to its uneven shape and will shift in multi-directions for advanced proprioception and body awareness. The professional-grade, heavy-duty PVC material is formulated for use with dogs, provides superior gripping and resists damage caused by dog nails. When used in a core conditioning program, the FitPAWS Egg can improve balance and coordination as well as stabilize weak areas. The FitPAWS Egg easily inflates with an air pump (sold separately). You can also adjust the balance challenge by under-inflating so the ball is not as firm.



<b>J1127b</b>	85cm/33.5"	Blue
<b>J1127a</b>	65cm/25"	Green

**FitPAWS® Donut.** The FitPAWS® Donut may be used as a balance training tool or for core strengthening for small dogs that may be overwhelmed by the Peanut or Egg. It can also be used for weight bearing therapy. The professional-grade heavy-duty PVC material is formulated for use with dogs, provides superior gripping and resists damage caused by dog nails. The FitPAWS Donut provides a moderate balance challenge. Its broad base offers more stability than a round ball. It has textured bumps on one side and a smooth surface on the other side. It is approximately 12" high and easily inflates/adjusts with a hand-held air pump (sold separately).



<b>J1128</b>	approx. 12"	Dark Blue
--------------	-------------	-----------

**FitPAWS® Balance Disc and Giant Balance Disc.** The FitPAWS® Balance Disc may be used for weight bearing activities and balance training for sporting and working dogs or for animal rehabilitation and therapy. The professional-grade heavy-duty PVC material is formulated for use with dogs, provides superior gripping and resists damage caused by dog nails. The FitPAWS Balance Disc has a 14" training surface and may be used in multiples to create a balance training course. The FitPAWS Giant Balance Disc has a 22" training surface, perfect for medium/large breeds. Both discs have two training surfaces, a flat/smooth side and a textured surface. The balance challenge can be easily adjusted by removing or adding air with a needle pump for the 14" balance disc or an air pump for the Giant balance disc. (Pump sold separately.)



<b>J1129b</b>	22" training surface	Blue
<b>J1129a</b>	14" training surface	Blue

*We recommend your dog wear a safety harness you can hold onto, while your dog is exercising on the ball. Read all safety, care and use instructions before using your FitPAWS Canine Conditioning Equipment.*



**Circulating Water Blankets and Pumps.** Hypothermia is a constant risk for the small veterinary surgical patient. Approximately 60-70% of surgery patients become hypothermic. Recent human medical studies have proven that keeping patients warm during and after surgery can markedly improve clinical outcomes. This system places a flat comfortable vinyl blanket under the patient. Warm water is circulated throughout this blanket by a special electrical pump. This pump maintains your selection of temps (86°–107°) within 1.5°F. The pump is matched with the blanket size and material of your choice.

This pump has a number of important features:

- Audible Alarm: low water, tilt
- \*1 year warranty open sensor and high temperature
- Self-sealing connectors for no water leakage
- Dual thermostats for safety \* Includes 8 feet of connecting hose
- 10"(h) X 7" (diameter) weighs 6lbs \*Micro Processor Control
- 50 oz. Water reservoir \*Digital LED Readout
- Can use tap water \*Flow rate 15 gallons/hour
- 8 ft electrical cord \*ULapproved

- J0783x** Circulating Water Pump.
- J0783xpc** Pad Cradle
- J0783xs** IV Stand Attachment

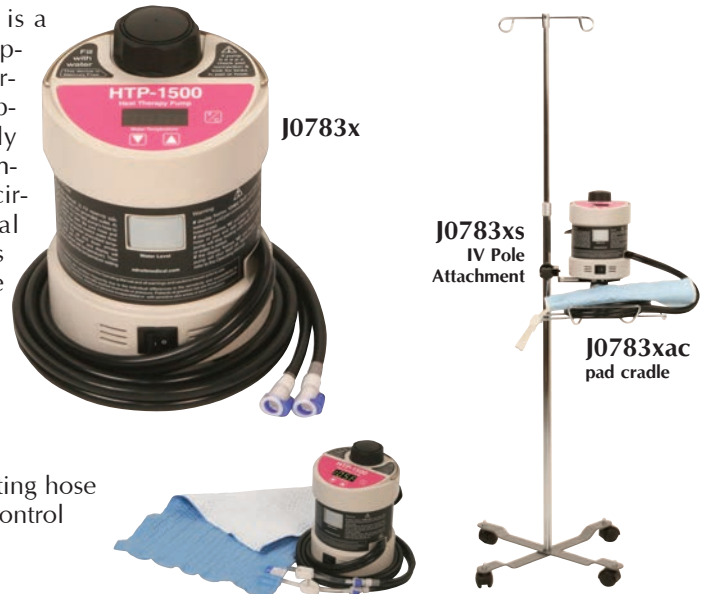

**Circulating Pads and Blankets** come in convenient sizes with a choice of two materials. Circulation is up to 3 times faster than other flow patterns. JorVet's random flow design yields faster, more effective circulation, resulting in even temperature distribution. The self-sealing connectors are set up in just a snap. The pads are easy to wipe clean.

**Maxitherm Vinyl Blanket.** 12g vinyl.

- J0784ax** Vinyl Blanket. Small. 13.5" x 18.5".
- J0784bx** Vinyl Blanket. Medium. 26" x 33".



**Blanket/Pump Connector.** *These quick-release connectors allow connection to other brands of hot water pumps and blankets (ie., Gaymar and Baxter).*

All Jorvet blankets come fitted with a male connector and an extra female connector. The female connector allows a hose from any brand pump to be connected to our blanket.

- J0784z** Connector. Female.
- J0784x** Connector. Male.
- J0784y** Connectors. Set of male and female.



Easy Set Up with Color-Coded Quick Connectors. Shut-Off Clamps Prevent Leaks During Set Up & Disconnection.

**Protect-A-Pad.** There is a widespread use of circulating hot water blankets in veterinary medicine. An animal's sharp claws can very easily puncture these blankets. These cover pads are a soft padded, quilted cotton that protects the water blanket and provides comfort for the patient. The blanket has excellent heat transference and is inserted between the pad layers with Velcro closes. Protect-A-Pads work with most brands of circulating hot water blankets. Machine washable.

- J0784q** Protect-A-Pad, Small. Fits 12" x 18" – 18" x 24" blankets.
- J0784r** Protect-A-Pad, Medium. Fits 22" x 30" blankets.



J0784q & J0784r

**Warming Air Blankets.** Keeping patients warm during surgery and recovery has always been a challenge. Electric pads have a risk of overheating, circulating water blankets are easily damaged.

Our new warm air blankets are a safe, economical solution to this problem. They are made of a silky polyester fabric with an inlay of nylon water proof material to keep the airflow circulating upward towards the patient.

These blankets are machine washable (hang to dry) therefore much more economical than other air blankets on the market, which are disposable. There is a 5" diameter round opening with a nylon cord to secure the blanket to any of the major brands of warm air convection units.

Blanket sizes available:

<b>J1034</b>	<b>Small</b>	30"L x 20"W
<b>J1034a</b>	<b>Medium</b>	36"L x 24"W
<b>J1034b</b>	<b>Large</b>	48"L x 24"W
<b>J1034s</b>	<b>All 3</b>	



**J1034xn "Cloud 9" warm air system.** Hypothermia prevention. Keeping patients warm during surgery and recovery has always been a challenge. Electric pads have a risk of overheating, circulating water blankets are easily damaged. Most warm air units require the use of an expensive disposable blanket or are actually refurbished used units.

The "Cloud 9" warm air system provides warm air to flow to comfortably either from under or from the top downward over the anesthetized patient. Your patients will recover more quickly and safely when doing any procedure requiring anesthesia. This is the new standard of care for veterinary medicine and surgery. Totally new unit built in the USA to JorVet specifications.

"Cloud 9" features:

- 2 temperature settings: 100°F and 110°F
- 5 feet flexible clear connecting hose
- Dimensions 12.5"w x 12"d x 11.25"h
- Weighs 10.5 lbs
- Uses 110v AC power
- 1 year limited warranty (not on blankets or filters)
- Quiet operation
- Filtration 0.3 micron high-efficiency filter
- Includes set of 3 different reusable warming blankets (**J1034s**)



**J1034q Cage Connector for Warm Air Unit.** The use of warm air units for preventing hypothermia is a popular modality in veterinary medicine. The challenge is to pass one through a cage door to a patient. The JorVet cage connector:

- Fits any brand of cage
- Fits any brand of warm air unit
- Large wing nuts allow for quick removal
- Can go anywhere on cage door
- Inside cage hose is marked "bed" or "cage"
- Does not constrict flow

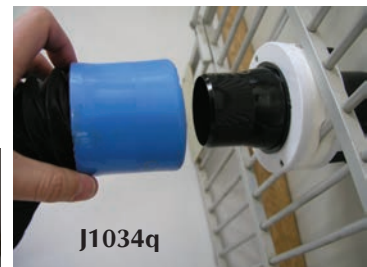



**J0461x Cage Card Holder.**

- Stainless steel ID card holder
- Standard 3 x 5
- Fits most brands of stainless steel cages by sliding tightly onto cage bars



J0461x

**Ecobag Dispenser with Replacement Bags.**

- Small black plastic dispenser of biodegradable bags with handles for easy tie off.
- Mounts easily in: waiting room, exam room, kennel, prep area.
- Choice of screw mount or double-sided sticky tape
- Common product in parks/trails but not readily available through veterinary distributors.
- Clients or pet owners are very familiar with it.

**J1102 Dispenser with 50 bags**  
**J1102b 50 refill bags**



**J1103 Pooper Scooper.** A simple device that every clinic needs!

- Two snap together handles
- Flat side or forked, shovel side
- Bin receptacle on the second handle
- Easy to clean
- No instructions necessary



J1103





Hypothermia is a constant risk for the small veterinary surgical patient. Patient comfort should be considered for every patient in a veterinary clinic, and your clients expect it.

**Deluxe Lectro-Kennel.** The new Lectro-Kennel has a separate temperature control with 3 settings.

- Can be read in either Celsius or Fahrenheit
- Includes sheepskin cover

Constructed of rugged, brown ABS plastic, the pad is completely water tight, easily cleaned, suitable for all makes of cages as well as kennel runs. Lectro-Kennel is equipped with a steel wrapped abrasion resistant electrical cord. One-year warranty.

**J0916 Kennel.** Feline/Small. 12<sup>1</sup>/<sub>2</sub>" x 18<sup>1</sup>/<sub>2</sub>" 40 watt.

**J0916a Kennel.** Medium. 16<sup>1</sup>/<sub>2</sub>" x 22<sup>1</sup>/<sub>2</sub>" 60 watt.

**J0916b Kennel.** Large. 22<sup>1</sup>/<sub>2</sub>" x 28<sup>1</sup>/<sub>2</sub>" 80 watt.



J0916 series

**J0917 Thermo Pet Mat.** A less expensive warming unit, consisting of a blue flexible 6-watt warming pad placed inside a washable faux lambskin cover. The convenient 14" x 28" size fits all standard cages. The pad is preset to be thermostatically controlled to 102°. U.L. approved. Limited one-year warranty



J0917

**Thermoblocker Hypothermia Prevention products.** The 'space blanket' became popular a number of years ago. It used a thin silver reflective coating to back radiant heat. It is still highly utilized in search and rescue. The thermoblocker blanket takes this concept a step further.

1. Top reflective layer returns nearly 80% of the radiant heat from the animal.
2. Any heat that passes through is slowed by insulating bubble wrap and kept in the material by the second reflective layer.

Almost no heat passes through the Thermoblocker:

- The padding adds comfort
- Easy to clean
- Very light weight

**J0955 Thermoblocker** 46" (115cm) x 25" (60cm)

Thermoblocker Recovery Bag. Same heat reflective core material. The recovery bag works like a sleeping bag with two sides stitched together and integral Velcro strips on the other two sides.

**J0955a cats/small dogs** 30" (70cm) x 18" (45cm)

**J0955b kittens/puppies** 18" (45cm) x 14" (35cm)

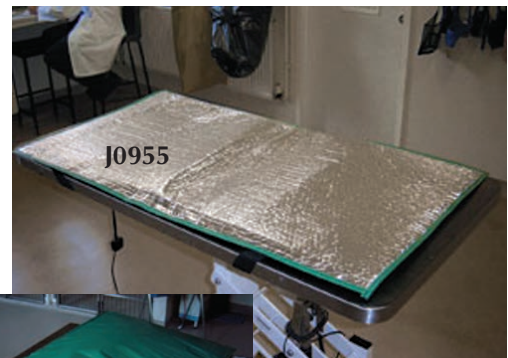

J0955



J0955a and b

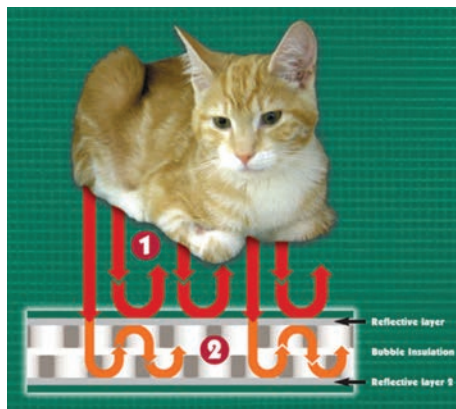

**Warm Blood Gen II**



**Hypothermia Prevention System.** The “Warm Blood” patient warming system by **Jorgensen Laboratories** uses FabRoc™, a patented conductive polymer which heats quickly and evenly when low voltage is supplied. Learn more about this cutting edge heat technology, which is used in a variety of industries worldwide, at [www.exo2.com](http://www.exo2.com).

Scores of consumer and industrial products are made with FabRoc™ such as warming vests, heated gloves, hypothermia solutions for the US military, medical wraps, etc. The flexible nature of the technology and the durability of the entire system allow the blankets to be used under or on top of any patient. The **Warm Blood** can be used on the table or inside the cage.

When the FabRoc™ conductive fabric reaches its desired temperature, it exhibits Positive Temperature Coefficient (PTC) properties. This means that the fabric is self-regulating and draws less energy from its power source until it is once again needed in order to maintain its manufactured temperature. This promotes both a safe and an efficient hypothermia prevention solution.

With these features and benefits, the **Warm Blood** does not require expensive controller units or thermostats to provide even, continuous warmth.

**Warm Blood**

- Is safe for use in medical environments, uses low voltage, and does not use wires or chemicals to produce heat
- Is easy to clean and made with waterproof upper and lower rip-stop Cordura fabrics
- Is comfortable, soft and lightweight
- Is flexible but durable
- Heats uniformly with no cold or hot spots

**Power Supply & Temperature Controller**

- 110-240VAC is converted to 15VDC for safe and reliable use, reducing risk of electrical shock
- The waterproof 4 level controller provides custom heat settings up to 110°F (on HIGH)
- Both the power supply and the controller provide easy to use and maintenance free operation

**All Warm Blood Units Include:**

- A Hypothermia Prevention Pad with 15VDC, 90W, Slim-line Power Supply
- Four Level Waterproof Controller

The Warm Blood comes with a One Year Limited Warranty against latent defects. Damage caused by incorrect use or maintenance is not covered by the limited warranty.

- J1160n Small Warm Blood** - 10" x 22"
- J1160an Medium Warm Blood** - 18" x 22"
- J1160bn Large Warm Blood** - 26" x 22"
- J1160sn Set of all 3 sizes** with 2 Controllers/Monitors

**Tips for Best Use:**

- Do not leave an unconscious animal unattended on the Warm Blood.
- If ripped or torn, please contact Jorgensen Laboratories for a replacement. Damaged components should not be used.



J1160 series

The Warm Blood is Proudly Made in the USA!



*Note: Never leave any recumbent animal on any warming device unattended or for extended periods beyond 30 minutes unless device temperature is at or below body temperature of 100° F.*

**J0784w** **JorVet Thermal Pad** is a very effective, economical source of providing warmth to retain or increase body temperature for your veterinary patients. Thermal heat is circulated by standard warming blanket placed between two sturdy sheets of 21" x 27" polypropylene <sup>5</sup>/<sub>8</sub>" thick. This plastic pad has a smooth surface for easy cleaning and is extremely puncture resistant.

This system connects to our Thermal Pump (**J-783t**), and comes with connectors to adapt to other circulatory water pumps on the market.

**J0784b** **Replacement Circulating Blanket.** 22" x 30".

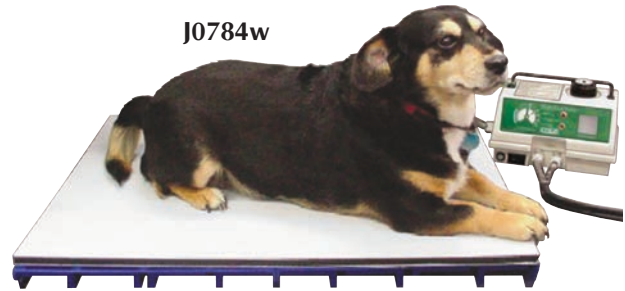

**Safe 'n Warm Foam Mat.** Post-op patient comfort is simple and easy with these foam padded mats. The core is constructed of thick foam for cushion and comfort. Seamless coating eliminates accumulation of dirt or debris. Totally non-absorbent; allows easy cleaning with standard hospital disinfectants. Just wipe clean with a paper towel. The mat reduces hypothermia, unlike cold stainless steel or metal grate surfaces that drain body heat. Lightweight and portable, can be moved from location to location.

- Fits inside standard cages (i.e., Shor-Line and Suburban)
- Slight bevel tips fluid toward drainage, 1 1/2" to 1/2" taper
- Especially valuable for post-op comfort

**J0766** **Safe 'n Warm Exam Table Mat.** Fits on top of standard stainless steel wall-mount or pedestal-type exam tables (i.e., Shor-Line and Suburban). Length just short of drain hole. 20" x 44" x 1/2".

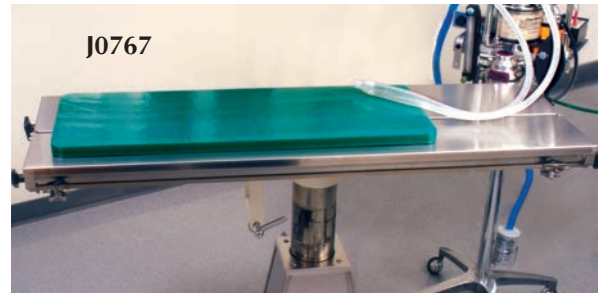

**Safe 'n Warm Surgery Table Mat.** Fits on top of standard stainless steel surgery tables (i.e., Shor-Line and Suburban). Length just short of drain hole.

**J0767** **Surgery Table Mat.** Short. 15" x 40" x 1".

**J0767a** **Surgery Table Mat.** Long. 15" x 50" x 1".

**Safe 'n Warm Scrub Sink Mat.** Fits on top of standard metal grate-style scrub sinks (i.e., Shor-Line or Suburban).

**J0768** **Scrub Sink Mat.** Short. 20" x 30" x 1".

**J0768a** **Scrub Sink Mat.** Long. 20" x 44" x 1".



**Safe 'n Warm Standing Fatigue Mat.** What about the veterinarian or the staff? Long hours of standing on hard floors during surgery or even in the reception area can develop leg and back soreness.

These comfortable mats also work for people. Tapered or beveled edges for safety.

**J0769** **Standing Fatigue Mat.** 19" x 38" x 2".

**J0769a** **Standing Fatigue Mat.** Large. 29" x 38" x 2".





JorVet offers a variety of inexpensive **Disposable Feeding Bowls** and **Litter Pans**. No need for scrubbing and cleaning bowls, plus they reduce possible disease transmission. The clinic staff will find these easy and convenient to use. Used dishes are recyclable.

**Disposable Food Tray Bowls** are coated paper, which limits cost to just pennies each. They nest together and require very little storage space. 1,000/case.

- J0974a** **Tray Bowl.** Small. 5" x 4" x 1 1/2". 8 oz. capacity.
- J0974b** **Tray Bowl.** Medium. 6" x 5" x 1 3/4". 2 lb. capacity.
- J0974c** **Tray Bowl.** Large. 10" x 7" x 2 1/4". 5 lb. capacity.



**Disposable Water and Food Bowls** are constructed of a special high-density recyclable foam that is sturdy and completely waterproof. Perfect for either holding liquids or solid food. Hard to tip over.

- J0975a** **Water and Food Bowl.** 8 oz. capacity.
- J0975b** **Water and Food Bowl.** 16 oz. capacity.



**J0976** **Plastic Disposable/Reusable Litter Pan.** Clear plastic for easy cleaning. Higher lip holds in litter better. Recyclable. 9" x 12" x 2 1/2". 100/case.

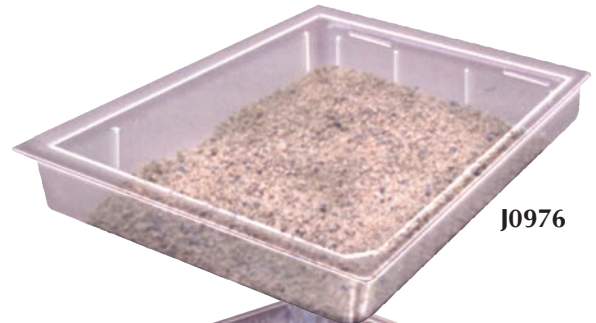

**J0976a** **Aluminum Disposable/Reusable Litter Pan.** This sturdy all-aluminum pan can be reused or recycled. Cleans easily. 9" x 12" x 1 1/2". 100/case.



**J0976b** **Disposable Pulp Litter Pan.** Economical, sturdy, and disposable, these treated pulp litter pans cost just a few cents each. Stackable for easy storage. Requires only a small amount of litter. 9" x 12" x 1". 250/case.

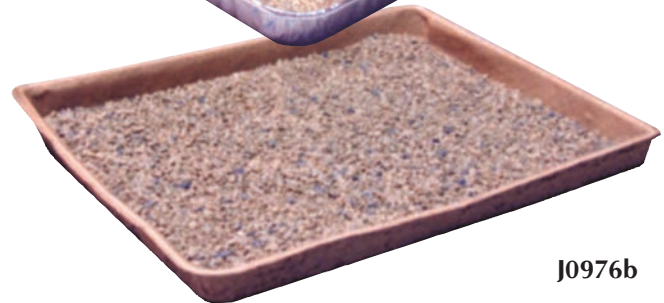

**Disposable Pulp Water Bowls.** These bowls will hold water!

- 100% recycled paper
- Made in USA
- 100% compostable in composting facilities

- J0975c** **31 oz non-tipping Bowl.** For medium to large dogs. 250 per case.
- J0975d** **Small 4 oz Bowl.** Perfect for cats and small dogs. 500 per case.



**BUSTER IncrediBowl.** Newly designed bowls help greatly reduce spilled water and food in confined animals. This reduces cleanup and waste.

- Antislip material makes the bowl stay in place while animal is eating
- Overlapping edges makes it difficult for water to splash out into cage
- Low center of gravity makes the bowl hard to knock over
- Soft rubber-like material (TPE) is a food grade material
- 4 different attractive colors
- 2 different sizes – 2 liter (2 qt, 32oz) and 1 liter (1qt, 16oz)

2 liter (10"L x 6"W x 3<sup>1</sup>/<sub>2</sub>"H) opening (6<sup>3</sup>/<sub>4</sub>" x 4")

- J1114 Magenta
- J1114a Lime Green
- J1114b Dark Grey
- J1114c Dark Blue

1 liter (7"L x 5"W x 3<sup>1</sup>/<sub>4</sub>"H) opening (5<sup>1</sup>/<sub>2</sub>" x 2<sup>1</sup>/<sub>2</sub>")

- J1114d Magenta
- J1114e Lime Green
- J1114f Dark Grey
- J1114g Dark Blue

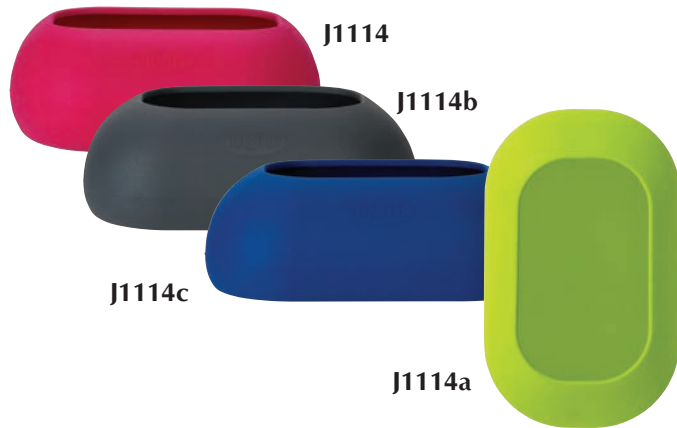

**J1082 Absorbent Kennel Pads.** *Not all kennel pads are created equal!*

The JorVet Kennel pads are highly absorbent with a special polymer that is designed to absorb 1000ml of water. Make sure you are using a kennel pad that actually keeps the patient dry and does not have to be changed with every drop of fluid.

Also useful for procedures like dental prophylaxis to help maintain a dry field. Blue color with quilted pad. Size 23" x 36". Weight 85gm. 50/pk.

**Reduce odor in your clinic.**



**Coated Cage Rack.** PVC-coated expanded metal floor racks are a must for animal comfort and hygiene. The racks are dipped in plastisol for a uniform 1/8" coating. The diagonal grid is easy to clean with virtually any disinfectant.

This coating gives the patient a softer and drier resting place while under your care. The racks are elevated 3/4" allowing the patient to remain dry and clean. Guaranteed against breakage for 3 years. Fits Shor-Line®, Surburban® and VSSI cages.

**J0840r Rack.** 27<sup>1</sup>/<sub>2</sub>" x 27<sup>1</sup>/<sub>2</sub>". 16<sup>1</sup>/<sub>2</sub> lbs. For 30" cage.



**Cage Caddy.** It is important to keep a hospitalized patients' personal items such as medications and collars close by and organized. The JorVet Cage Pet Caddy hangs securely from the patient's cage door bars. It can be also readily moved to a new cage. Two models available.

- J1152 Clear Cage Caddy PETG.** 3 1/2" h x 8 3/8" w x 3 1/4" d
- Two hooks back attach onto cage bars. Clear material allows easy visualization of contents.
  - Sloped top allows any fluid to run down and off
  - Virtually unbreakable PETG.
  - Hinged top door

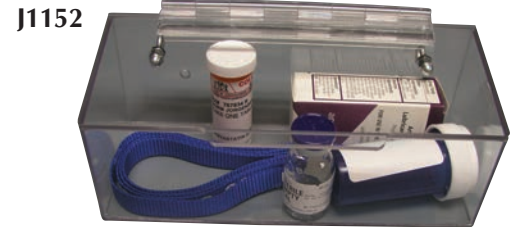

- J1152a Blue plastic.** 3 1/16" h x 12 3/4" w x 4 1/16" d
- Slightly larger
  - Less expensive
  - Used in human hospitals
  - Three compartments
  - Polypropylene



**Clear Dispensing Bins.** These attractive storage bins are great for keeping high use items close at hand.

- Three different sizes
- Clear rigged polycarbonate: can easily see contents
- Lid has magnetic back so can stay open

*Some suggested uses*

- Dispensing vials
- Sampling jars
- Blood tubes

**J1153 Clear dispensing bin small** 5 1/2" w x 9 1/2" x 9" h

**J1153a Clear dispensing bin med** 6 1/2" w x 10 1/2" x 9 1/2" h

**J1153b Clear dispensing bin large** 7 1/4" w x 12 1/2" x 11" h

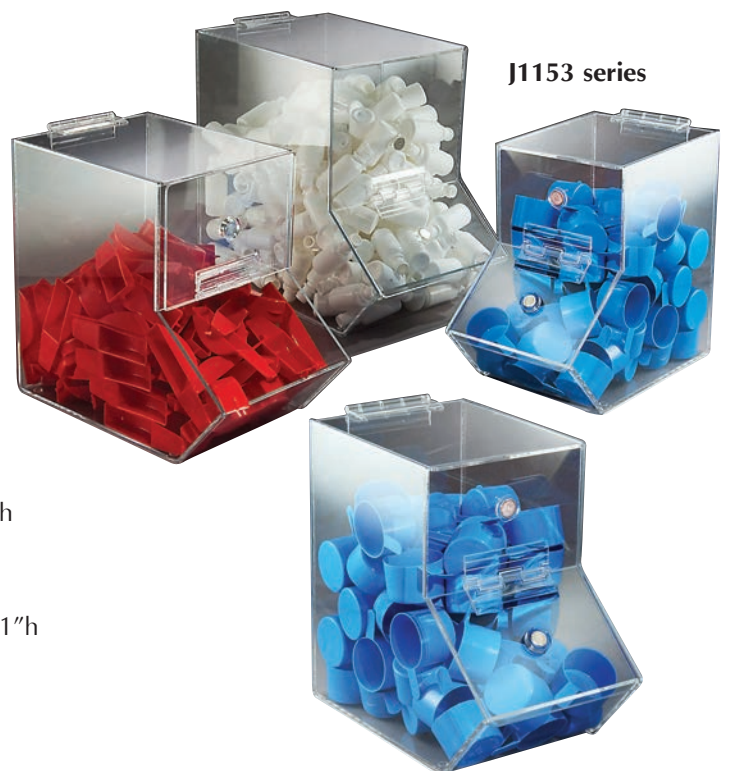



## PET COMFORT

*Are your patients comfortable during their stay at your clinic?*

The bottom of cages and kennel runs are simply hard and cold. Clients expect their pets to be treated with the best care which includes the best in comfort. A comfortable patient will have less stress which makes for a better healing environment.

**Colorado Landing Cots.** These cots or miniature beds elevate the pet off the hard, cold cage or run floor.

- A heavy duty blue nylon mesh allows for fluid drainage.
- Powdered coated blue steel framing with stainless steel nuts and bolts
- Easy to clean: can remove nylon mesh to wash or soak entire bed in many disinfectants
- Lightweight tubing so its easier to move than other metal cage grates
- Stackable for easy storage
- Cats especially love the higher elevated model
- Easy to assemble
- Affordable: much less expensive than metal cage grates

- J1357**     **Small** 27<sup>1</sup>/<sub>2</sub>" long x 15" wide x 4<sup>1</sup>/<sub>2</sub>" high, 4 lbs.  
**J1357a**   **Medium** 27<sup>1</sup>/<sub>2</sub>" long x 21<sup>1</sup>/<sub>4</sub>" wide x 4<sup>1</sup>/<sub>2</sub>" high, 4.7 lbs  
**J1357b**   **Large** 27<sup>1</sup>/<sub>2</sub>" long x 27<sup>1</sup>/<sub>2</sub>" wide x 4<sup>1</sup>/<sub>2</sub>" high, 5.2 lbs  
**J1357f**   **Elevated feline** 27<sup>1</sup>/<sub>2</sub>" long x 15" wide x 14" high, 4.5 lbs.

Replacement nylon mesh covers are also available.

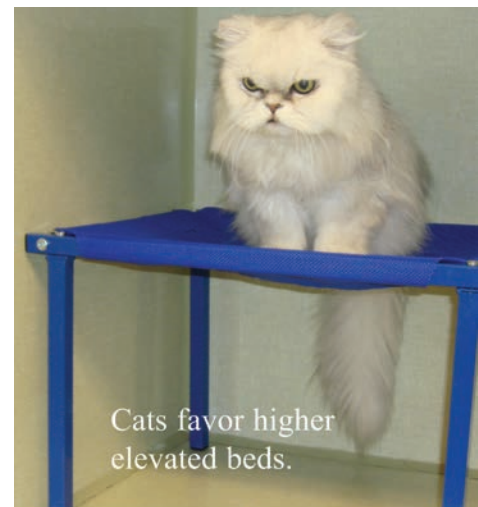

**Comfort Pads.** Soft foam padded cushions.

- Water repellant fabric that is easy to wipe clean
- Durable: can last a long time
- Sized for standard cages
- Inexpensive solution
- Light green, neutral color
- Soft material will not bottom out

**NEW**

- J1292a**   **Small** 27<sup>1</sup>/<sub>2</sub>" wide x 15" long x 2" thick  
**J1292b**   **Medium** 27<sup>1</sup>/<sub>2</sub>" wide x 21<sup>1</sup>/<sub>2</sub>" long x 2" thick  
**J1292c**   **Large** 27<sup>1</sup>/<sub>2</sub>" wide x 27<sup>1</sup>/<sub>2</sub>" long x 2" thick

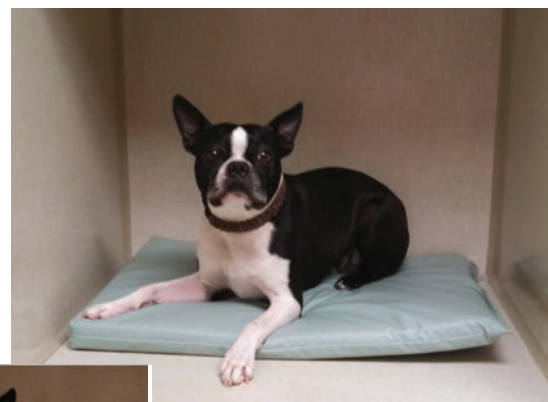

**J1292**



JorVet offers a wide range of pet beds which provide a comfortable and attractive place for your patients to stay during their clinic visits. They will fit inside standard cages and kennels.

**Buster oval comfort beds**

- A fashionable design using premium materials
- Easy to clean – completely machine washable and dryer safe
- Durable thickly padded material

**Silvia Pattern.** Fuchsia center pad and black outer lining

**J1290** 50cm (20") width

**J1290a** 65cm (26") width

**Roma Pattern.** Red center pad and black outer lining

**J1290b** 50cm (20") width

**J1290c** 65cm (26") width



J1290



J1291

**JorVet Antislip Pet Beds.** These antislip beds provide a soft protective padding for cats and dogs. They can help maintain body temperature after surgery or anesthesia. All vet beds are machine washable and dryer safe at low temperatures. The backing has a non-skid latex surface. Density 1,400gm/m<sup>2</sup>. Medium gray color

**J1291** 48cm (19") wide x 38cm (15 1/4") long

**J1291a** 66cm (26 3/8") wide x 51cm (20") long

**J1291b** 71cm (28") wide x 61cm (24") long



The ergonomics of today's workplace make the use of **Comfortable Medical Seating** a necessity. Chronic straining from bending over or crouching during surgery, examining a patient, or doing lab work can be avoided by the proper use of medical seating.

Inside the JorVet "Soft Feel" Foam System: Our top layer of super soft, super comfortable foam is where you really feel the difference. Our bottom layer of resilient, durable high-density foam is why you appreciate the JorVet difference, year after year after year.



**J0809 Chrome-Base Stool.** Fitted with a 14" diameter seat padded with 4 $\frac{1}{2}$ " foam. Stain resistant upholstery allows easy cleaning. The seat height is adjustable with a smooth machine screw ranging from 19"–25", on a solid steel shaft. The 1" tubular frame and round foot ring is completely chromed (including the welds). Rolls on 2" vinyl.



**J0809pL Laboratory Stool** is needed by anyone using a microscope. Provided with a pneumatic height control lever that ranges the seat level from 22.5"–30". The stain resistant upholstery covers a 4 $\frac{1}{2}$ " thick, comfortable seat. In addition, personnel can adjust the foot ring and back rest. A tip-safe 5-leg brushed aluminum base is fitted with hooded dual wheel nylon casters.

**J0809p Premium Pneumatic 5-Leg Stool.** Pneumatic easy, single lever seat height adjustment ranging from 18"–23.5". The easy-to-clean 16" diameter seat is padded with 4 $\frac{1}{2}$ " foam for comfort. The 23" brushed aluminum base is equipped with hooded dual wheel casters.

*NOTE: Specify color selection by adding a letter after the product code: B–Black, N–Navy for J-809, J-809pL and J-809p.*

*NOTE: If ordering with stool, specify back rest by adding "R" after the product code and color.*

**J0809r Optional Back Rest.** Not high enough for use as laboratory stool. For use with pneumatic stool.





**J0989 Eyewash Station.** OSHA approved and installs easily on your faucet. The Opt.-Klens Eliminator series of OSHA accepted eye wash stations are wonderfully designed to fit on the existing faucet in your clinic. This station allows your every day faucet to double as an OSHA accepted eyewash station for emergencies. No special plumbing required, simply attach to any faucet with the adaptor kit that is included and you are ready to go. To activate the eyewash, use the one step procedure of simply pulling the button on the front of the device and water will flow immediately at up to 3 gallons per minute! (And did we mention it is OSHA accepted?)



J0989

**J0989x Personal Eyewash Station.** Mount on wall to provide immediate relief. This station holds two 32 oz. dosing bottles for thorough decontamination of face and eyes. Comfortable molded eye socket opening allows full flow of solution to completely irrigate affected eye. Imprinted emergency use instructions are on each bottle and station wall. Bottles are shipped empty to fill with water or saline depending on local regulations. Securely mount station with top and bottom holes (hardware included). Measures 17" W x 4" D x 14<sup>1</sup>/<sub>2</sub>" H.



J0989x

#### Biohazardous Disposal Pouches and Stand.

**J0723 Biohazardous Disposal Pouch.** Safely contain sharp-edged objects like scalpel blades and needles for disposal. The 10mm thick paperboard folds to an oval shape. The bottom is secured by double-sided tape on one flap. The fold-down top secures bag when full. English instructions on front, Spanish on back. Inexpensive. 5<sup>1</sup>/<sub>2</sub>" x 13". 100 pouch/pk.

**J0723h Epoxy-Coated Steel Wire Stand** attractively holds pouch. Put one in every exam room.



J0723

J0723h

**J0724 Biohazard Bag Holder and Bag.** Handy size bag and holder are ideal for collecting lab samples like blood tubes. Bag stays open until you are ready to dispose of it. These 1.5mm thick polypropylene bags can be safely autoclaved. An indicator patch darkens when sterilized. Very inexpensive. 3.6" x 5.1" x 8.4." 100/pk.

**J0724h Epoxy-Coated Steel Wire Holder.**



J0724

J0724h

**J1081Q Chemo Protect Vial Venting System.** The use of some pharmaceuticals presents risks to the clinic staff. Ensure the safe transfer of these medications from rubber stopped bottle to syringe.

- Protects against inhaling toxic drugs
- 0.2 micron filter
- Sterile, pyrogen free and non-toxic
- Large surface reduces risk of air lock and clogging
- Special spike prevents



J1081Q

**Right to Know/MSDS Information Center.** Is your clinic OSHA compliant? OSHA requires that all MSDS information be readily available and easily accessible. Failure to do so is one leading cause for an OSHA citation.

- The attractive signage and MSDS binder
- Binders hold 300 sheets
- Epoxy coated wire racks will not rust and allow for easy viewing of titles
- Backboard made of durable polystyrene
- Wall mounting hardware included
- Tear resistant three ring binder clearly identifies content
- 14" w x 4.5" d x 20" h

**J1194 Rack and Binder with signage**  
**J1194a Binder Only**

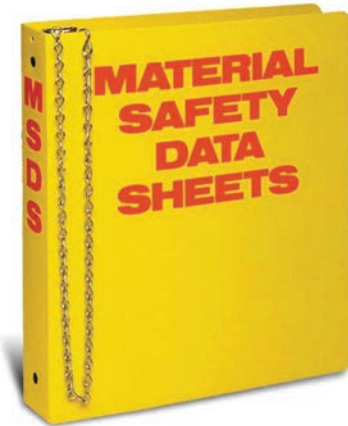

**Sharp's Containers.** Veterinarians increasingly understand the need to be in compliance with government regulations from agencies like OSHA and the EPA. These regulations require proper disposal of medical waste in containers specifically designed for such use. These red plastic containers are especially designed for easy and proper disposal of items such as hypodermic needles, suture needles, and scalpel blades.

The top lid has a special slot that helps removal of hypodermic needles from their hub. When the container is completely full, the lid seals permanently and tightly for proper disposal.

**J0886 Four liter size.**  
 Bottom: 18cm long x 12 cm wide  
 Top: 20cm long x 14cm wide  
 Height: 16cm  
 Note: This four liter holds more than the popular four quart size.

**J0886a 0.5 liter—sized right for exam rooms.**  
 Bottom: 7cm long x 7cm wide  
 Top: 8cm long x 8cm wide  
 Height: 15.7cm



**Biohazard disposal bags.** Orange-red. Look for the sterilization indicator patch. The days have passed when veterinarians simply disposed of their hazardous waste like surgery gloves, drape, and animal body parts in the trash. Medical standards require responsible disposal of medical waste in appropriately marked bags that can be safely autoclaved.

A large biohazard symbol and precautionary in four languages are clearly visible for safety. Made of high molecular weight, high density (HMHD/polyethylene) and are steam autoclavable up to 121°C (250°F).

	Gallon Capacity	No. of Bags	Size
<b>J1067</b>	2 to 4	50	36 x 48cm
<b>J1067a</b>	6 to 9	50	48 x 58cm
<b>J1067b</b>	20 to 30	50	79 x 97cm



**Seirin J-Type Needles.** The J-Type acupuncture needle is renowned for its role in producing gentle, painless and stress-free treatments. Made from the highest quality stainless steel, it features a lightweight, comfort grip, 2.0 x 20mm plastic handle that is color coded for easy gauge identification. With Light Touch Insertion™, the needle is easily released from its guide tube by gently pressing the needle away from its point of attachment on the tube. Each needle comes individually packaged with its own polypropylene guide tube, which is rounded on the end for patient comfort and is 100% PVC free. Box of 100 sterile, disposable needles.

**Seirin J Type needles with insertion tubes**

Product #	Needle diameter	Japanese Gauge	Chinese Gauge	Needle Body Length
J1120	0.16mm	1	#40	1"
J1120a	0.16mm	1	#40	1 1/2"
J1120b	0.18mm	2	#38	1"
J1120c	0.18mm	2	#38	1 1/2"
J1120d	0.20mm	3	#36	1"
J1120e	0.20mm	3	#36	1 1/2"
J1120f	0.25mm	4	#32	1"
J1120g	0.25mm	4	#32	1 1/2"
J1120h	0.30mm	8	#30	1"

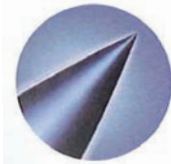

SEIRIN needles are of consistent, uniform, high quality finish as seen in this photomicrograph.



J1120 series

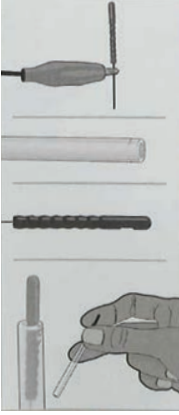

Electrically conductive needle body. (use 3 gauge or larger)

Guide tube edges are rounded for patient's comfort.

Concave-convex surface needle handle for easy grip and positive control.

Prior to insertion, the needle is released from the insertion guide tube by gently rotating and pressing the exposed side of the handle opening. Twisting will also release the handle.

**HWA-TO Basic.** Sterile, disposable, surgical stainless steel Chinese style acupuncture needles with spiral wound copper handle. 10 needles per individually sealed foil sheet with no insertion tube. Preferred by equine specialists with longer length and needle thickness.

Product code	Needle diameter	Japanese/ Chinese gauge	Needle body length
J1122	0.25mm	5/32	3" (75mm)
J1122a	0.30mm	8/30	3" (75mm)
J1122c	0.30mm	8/30	5" (125 mm)

**HWA-TO singles with Tubes.** Sterile, disposable, surgical stainless steel Chinese style acupuncture needles with spiral wound copper handle. One needle with one insertion tube per sterile, individually sealed blister package.

Product code	Needle diameter	Japanese/ Chinese gauge	Needle body length
J1121	0.20mm	3/36	1" (25mm)
J1121b	0.22mm	4/34	1"
J1121c	0.22mm	4/34	1 1/2"
J1121d	0.25mm	5/32	1"



**Acupuncture needles.** Manufactured by one of the largest Chinese acupuncture needles companies for JorVet. Quality but, yet very affordable. Box of 100 needles with insertion tubes, spiral wound head.

- J1107 Acupuncture Needles. 0.16mm x 25mm
- J1108 Acupuncture Needles. 0.20mm x 25mm
- J1109 Acupuncture Needles. 0.25mm x 25mm



**J1123 Model IC-1107+.** The model IC-1107+ is a compact, lightweight, sturdy, palm-size, high quality Japanese electro-therapy device. A Hi/Low switch on the back of the unit allows low or high voltage output. Offers 3 independently controlled output channels with adjustable frequency indicated by flashing light.

Features a unique biphasic pulse from which has been designed to produce a balanced treatment. The pocket portable IC-1107+ is the smallest and smartest looking professional electro-therapy unit in the world, for use in or out of the office.

Accessories include 3 sets of new CE wire leads with rectangular CE jack, carrying case, belt clip, 9-volt battery, and instructions.

Specifications:	500-ohm test load
Output Channels	3 independent intensity channels
Frequency (adjusted with fine frequency detail)	L – 1 to 20Hz M – 20 to 150Hz H – 150 to 500Hz
Low volts and current	0 to 10 volts, 0 to 20 milliamps
Hi Volts and current	0 to 20 volts, 0 to 40 milliamps
Voltage, max	30 volts
Pulse width	100 microseconds ( $\mu$ S)
Pulse shape	asymmetric biphasic square wave
Pulse mode	continuous
Power source	one 9-volt battery
Freq indicator	flashing red light
Size, wt, color	4.5" x 3.2" x 1.2", 0.3lbs, beige

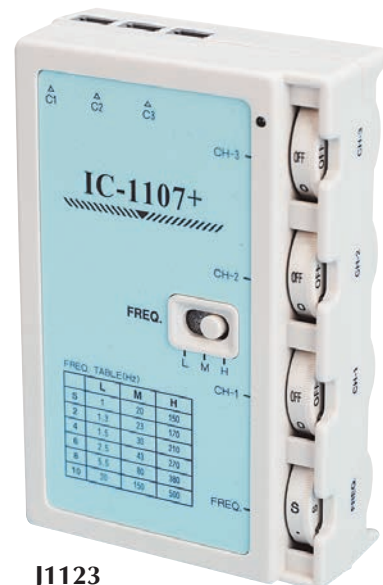

J1123

Acupuncture models

**J1124f Feline.** Plastic model from China. One side shows acupuncture points numbered from 1 to 36. The other side shows muscle, internal tissue, and structure in colors. Mounted on a 3" x 11" stand.

**J1124e Equine.** Plastic model from China. One side shows acupuncture points numbered from 1 to 114. The other side shows muscle, internal tissue, and structure in colors. Mounted on a 3" x 8" stand.

**J1124c Canine.** Plastic model from China. One side shows acupuncture points numbered from 1 to 71. The other side shows muscle, internal tissue, and structure in colors. Mounted on a 4" x 9" stand.

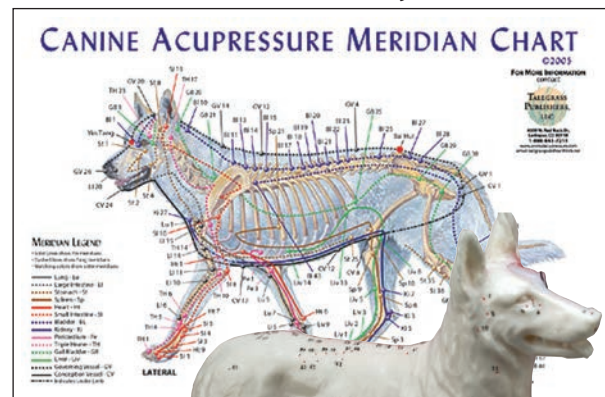

J1125c



J1124c

J1124e

J1124f

**J1125e Equine meridian**

**J1125c Canine meridian**

**J1125f Feline meridian**

## Class 3 and 4 Laser Therapy

**Therapeutic Laser Therapy** is quickly becoming a standard of high-end care for pain management and rehabilitation. All JorVet therapeutic lasers are made by Respond Systems, Inc. Located in Branford, CT, Respond Systems has been manufacturing lasers in the USA for more than thirty years.

Therapeutic lasers are separated into various classes according to their power output. A class IV laser has a power output over 500mW watts or 0.5 watts. Class 3B therapy lasers have a power output of 500mW or lower. Therapeutic lasers are indicated for use on a variety of conditions, acute or chronic. Use for:

- Post surgical pain management
- Wound healing
- Muscle tears
- Declaws
- Neurological injury
- Lick granulomas
- Dental procedures
- Hot spots
- Pneumonia
- Otitis
- Allergic inflammation
- Stomatitis
- Chronic degenerative conditions

### Class 4 Luminex Ultra - Modular system offers flexibility and power

**808nm Wavelength for Superior Results.** 808nm laser energy is an optimal wavelength for transmission into tissue, far less absorbed by blood and water than laser systems at 90nm and 90nm. Less absorption means no heating or burning at the surface and deeper penetration of laser light into the target tissue.

**670nm Red Laser Module for Superficial Treatment.** Introducing the first visible red laser probe designed for the veterinary market. Laser energy at 670nm is absorbed at or near the skin's surface, offering unique benefits for dermatology, dentistry, wound healing and neurological conditions. Pairs perfectly with the 808nm base unit to treat both surface and deep conditions.

**Lasers Designed for Safe and Effective Use.** Other laser systems must be held away from the skin, or moved constantly around the treatment area to avoid heating or burning, making accurate dosing difficult. JorVet Luminex Lasers are designed to have direct contact with the skin during the entire treatment, ensuring an accurate dosage and precise treatment, with no heating or burning.

#### Features:

- Dual laser Probes for versatile treatments
- Fiber optic probe tip for laser acupuncture
- Modular architecture for flexibility and growth
- No heating or burning like many other Class 4 lasers
- Adjustable pulsing frequencies
- Built-in protocols on a touch screen monitor
- Safe and easy for staff and patients

#### Specifications for Luminex Ultra Laser:

**Laser type:** GaAlAs Continuous and Pulsed  
**Wavelength:** 808nm, 670nm  
**Probes:** Profile Probe: 1 W maximum power at lens  
 Profile Probe Cap: – Fiber optic, 3 mm aperture  
 Advantage Probe: 5W maximum power at lens  
**Warranty:** Two years of free manufacturing defect  
**Power:** 110V-230V  
**Class:** VRH Class 4 laser

**J1183 Complete Luminex Ultra Two-Probe System**

**J1183a Single probe 5W 50sq. cm. system**

**J1183670 60nm Red Laser Module**

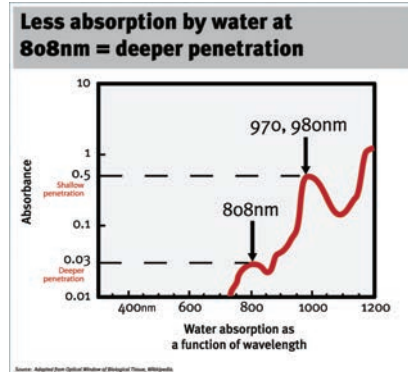

#### Power loss Contact vs. non-contact methods

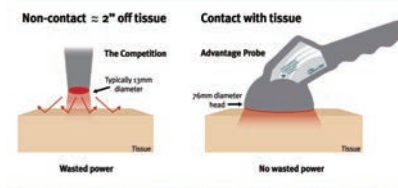

**No Power Loss.** The Luminex Ultra is safe to use in the contact mode, so there is no wasted power and no wasted money!



JorVet is also offers an economical, portable class 3B Luminex Vet Laser.

### Class 3b Lumine x Vet – Versatile probes treat small and large areas effectively

#### Profile Probe for precise treatments & accurate dosing

- 1 Watt probe emits 1 joule per second
- 1 square cm footprint for precise dosing in contact mode
- Fiber and lens deliver a homogenous beam – no hot spots
- Fiber optic tip for laser acupuncture

#### Advantage Probe for deep tissue therapy

- Super pulsed diodes for the deepest tissue penetration
- Large treatment head covers a full 50 sq cm for fast effective treatments
- 60W peak power drives laser energy into the deepest tissue with no heat or burning

#### Power and convenience in a small portable package:

- Easy to use display allows user to set dosage and power.
- Instant treatment parameters for quick start up with built in canine and equine protocols.
- Stylish and small with a convenient shoulder tote
- Carry between rooms, use on the table, on the floor or at your clients' barn or home.
- Up to 8 hours of continuous use on one battery charge. Recharges overnight.
- Rugged, padded carry case stands up to daily use and travel.

#### Equine indications:

- Muscle, tendon and ligament injury
- Wound healing
- Laminitis
- Sore backs
- Hock injury
- Sore stifles
- Hematoma
- Navicular
- Arthritis

#### Specifications for Luminex Vet

**Laser Type:** Profile Probe: GaAlAs Continuous – 808nm, 1 Watt

Profile Probe Cap: Fiber optic, 3 mm aperture

Advantage Probe: GaAs Superpulsed 904nm, 60 Watt Peak

**Warranty:** Two year free from manufacturer's discount

**Power:** Lithium-ion, rechargeable battery system

**Class:** BRH Class 3b laser

**J1183k Luminex Vet Complete Two Probe System**

**J1183m Luminex Vet Single Probe (50 cm<sup>2</sup>) System**

**J1183Lc Luminex Ultra Laser Cart.** The laser cart comes standard with one adjustable height shelf, handle, gas cylinder with adjustment lever, trunk with integrated cable management, base and five 4" locking casters.

Height range is 32" – 42". Holds up to 150 pounds on the entire cart; the top shelf can support up to 50 lbs. The column is balanced to lift 16-30 pounds. The cart has a lifetime warranty. The gas cylinder has a 5-year warranty. Product ships unassembled with all necessary tools. Assembly takes approximately 45 minutes.



J-1183Lc



Veterinarians, as part of their everyday practice, are counted on to offer professional and informed consultation on behavior and training issues for their canine patients.

Dr. Roger Mugford is an internationally recognized expert on behavior training. He has developed a number of innovative products in these areas. Dr. Mugford's products offer the clinic a useful tool in helping clients manage this area of major concern.

**What is the Pet Corrector and how does it work?** The Pet Corrector emits a hiss of compressed gas to interrupt a dog's unwanted behavior. The noise is similar to the hiss warning sound made by a cat or snake, alerting him to danger.



**NEW**

Jumping Up

**So, what can you use it for?** The Pet Corrector interrupts many unwanted behaviors but is most often used for:

- Barking
- Jumping up
- Stealing food
- Chasing
- Place avoidance

An essential combination of tool with reward-based training methods.

**Good to know**

- Used by trainers and behaviorists throughout the world
- The inert gas has no smell and is totally safe
- The Pet Corrector is a unique patented product
- Works on animals including cats, horses, and more

**Pet Corrector Tips:**

- Test the animal's sensitivity: operate at greater than one meter distance
- Direct the spray away from your pet's face (not directly toward it).
- Only use the Pet Corrector to interrupt a serious misdemeanor, it is not a substitute for poor training!
- Make the shortest possible bursts because the canister will chill with prolonged use.

**J1342 Pet Corrector**, 50ml cartridge

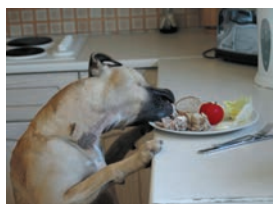

Stealing Food



Undesired Barking

**Baskerville Ultra Muzzle**

**NEW**

**What is a Baskerville Ultra Muzzle?**

The patented Baskerville Ultra was designed by Dr. Roger Mugford to protect against bites but at the same time be comfortable for the dog.

**How secure is it?** Very! The ergonomically designed safety strapping ensures the muzzle will always remain securely in place and features two additional points of secure attachment. The loop at the bottom is designed to attach to your dog's regular collar and there is an optional, removable over-head safety strap. The Ultra Muzzle also has a secure metal buckle with pre-holed webbing, to ensure it is fully adjustable, quick and easy to fit.

**Why use a muzzle?** Dogs wear muzzles for many reasons including inappropriate or aggressive behavior towards other dogs or people, and to comply with breed-specific legislation. Whatever the reason, it is important that the dog is happy and comfortable wearing a muzzle so that training can take place to resolve the problem.

- J1343a #1
- J1343b #2
- J1343c #3
- J1343d #4
- J1343e #5
- J1343f #6
- J1343s Set of all 6



See [www.JorVet.com](http://www.JorVet.com) for muzzle sizing suggestions based on dog breed.

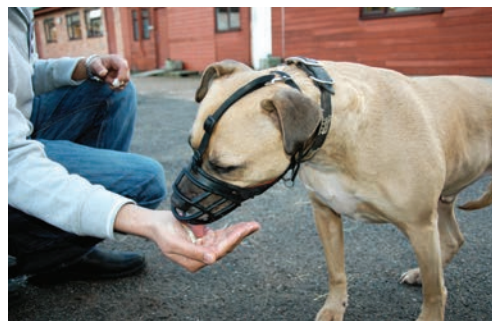



**NEW**

**CLIX CarSafe**

**What is the CLIX CarSafe Harness?** Designed by Dr. Roger Mugford, the patented CLIX CarSafe Harness provides safety and comfort for the dog, both in the car and while walking.

**Is it easy to fit and use?** Yes! Thanks to double-sided adjustable buckles, the harness clips together without the need to lift the dog's legs. The harness can be securely attached by either plugging straight into the seat-belt socket or by sliding the seat-belt through the extended handle.

**How secure and strong is it?** The CLIX CarSafe Harness is extremely strong, secure, and safe. The X-Cross feature over the chest provides a comfortable and ergonomic fit, while ensuring the harness remains in the optimum position over the strongest point on the dog's body.

**What is it made from?** The CLIX CarSafe Harness is made from safety-standard seat-belt material and has been designed in a continuous loop, to ensure that in the unfortunate event of an accident, maximum strength is retained.

- J1344a XS
- J1344b S
- J1344c M
- J1344d L

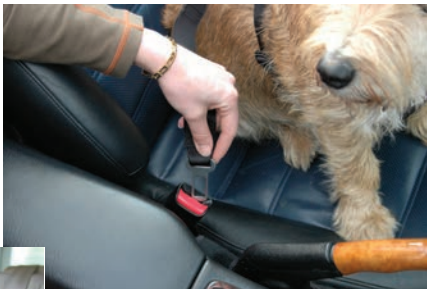

See [www.JorVet.com](http://www.JorVet.com) for chart on sizing.

**Green Slow Feeder**

- Eat slow
- Be healthy
- Have fun

**NEW**



**What is the Green Slow Feeder?** Green is the revolutionary way to turn a dog's meal into a challenging game. Many dogs lack mental stimulation which can lead to boredom and unwanted behaviors such as chewing. The Green keeps dogs mentally stimulated during feeding time, helping to reduce these behaviors.

**How does it work?** Designed like a tuft of grass but looking like a contemporary piece of art, simply scatter the desired amount of food across the green. The dog will then enjoy the challenge of pushing the food out between many blades of grass.

**How does this help?** The Green slows down eating time. By prolonging eating, the risk of vomiting, gagging, gas, and belching is also significantly reduced, resulting in a happier and healthier dog.

- J1345a **Slow Feeder Large Canine size**, green, for 30lbs plus
- J1345b **Slow Feeder Small Canine size**, green
- J1345c **Slow Feeder Feline size**, in light purple



A video on use of Slow Feeder is at [www.JorVet.com](http://www.JorVet.com)

See addendum to this section on page 402





**JorVet Pet Burial Boxes.** This is the professional and respectful way to return deceased pets to their owners. No more need to use old drug boxes. It is suggested to use a J-108 cadaver bag, then place the animal in the burial box. Available in 3 sizes.

**J0308a Small.** 14"L x 6.5"H(with lid) x 10.25"W. For cats and small dogs up to 15 lbs. 12 units.

**J0308b Medium.** 23"L x 9"H(with lid) x 14.5". For dogs up to 30 lbs. 10 units.

**J0308c Large.** 32"L x 11"H(with lid) x 14.25". For dogs up to 75 lbs. 5 units.

**J0308 Introductory Pack.** 3 small, 2 medium, and 1 large unit.



**Cremation Urn.** An increasing number of clients would like the option to keep the ashes from a pet's cremation. These beautifully done ceramic urns allow the veterinarian to return the ashes in a professional and tasteful manner. Black.

**J0310s Urn.** Small. (~maximum weight of animal is 40 lbs.) Urn weighs 1 lb.



**JorVet "Urnee" Cremation Urn.** Many cremation urns presently used are very expensive human urns or inappropriate items such as coffee tins.

The "Urnee" will satisfy the aesthetic requirements but at a cost low enough for routine use in returning crematory ashes.

- Attractive shape and color decorated with a raised relief rose centered on top
- Insert area for a memorable photo with snap-in cover
- Virtually unbreakable. Made from a heavy injection molded resin
- Inexpensive—costs about 1/4 of other urns
- Complete with a poly bag and tie for secure containment

**Small Urnee.** Animals <15 lbs.

**J0310sq Small Urnee.** Black.

**J0310sqt Small Urnee.** Tan.

**Large Urnee.** Animals 15–100 lbs.

**J0310Lq Large Urnee.** Black.

**J0310Lqt Large Urnee.** Tan.



**J0108 Cadaver Bags.** Heavy-duty 3ml black plastic. Strong enough to handle the sanitary disposal of animals. Full 35" x 48". 25 bags/pk. (not pictured)

<b>J0319G</b>	<b>Antique Bronze Heart Urn</b>	<b>2.9" x 2.7"</b>	5 cubic inches
<b>J0319H</b>	<b>Calico Heart Urn</b>	<b>2.9" x 2.7"</b>	5 cubic inches
<b>J0319K</b>	<b>Natural Patina Heart</b>	<b>2.9" x 2.7"</b>	5 cubic inches





**Terry Bear Urns.** JorVet introduces an expanded range of designer style pet urns to offer veterinarian clients a wider range of choices for cremation urns. All urns have a threaded screw on lid for security.

	Description	Dimensions (in inches)	Capacity (sq. in.)	Pet Weight (lbs)
J0316a	Classic bronze Urn, small	5.7 x 3.9	40	up to 35
J0316b	Classic bronze Urn, medium	7.0 x 5.0	85	35-65
J0316c	Classic bronze Urn, large	8.6 x 5.5	125	55-100
J0316d	Classic Pewter Urn, small	5.7 x 3.9	40	up to 35
J0316e	Classic Pewter Urn, medium	7.0 x 5.0	85	35-65
J0316f	Classic Pewter Urn, large	8.6 x 5.5	125	55-100
J0316g	Going Home Urn, small With Dove Inlays	5.3 x 4.2	45	up to 35
J0316h	Going Home Urn, medium With Dove Inlays	7.0 x 5.0	80	35-70
J0316j	Going Home Urn, large With Dove Inlays	8.5 x 5.6	130	70-120
J0316k	Silver Engraved Urn, extra small	6.1 x 3.9	25	up to 15
J0316L	Silver Engraved Urn, small	6.5 x 4.7	40	10 to 35
J0316m	Silver Engraved Urn, medium	7.5 x 5.6	70	30-60
J0316n	Avalon Evening Blue Urn, small	5.8 x 4.3	45	up to 35
J0316p	Avalon Evening Blue Urn, med	7.4 x 5.2	70	35-65
J0316q	Avalon Evening Blue Urn, large	8.4 x 5.8	130	65-120
J0316r	Avalon Mahogany Urn, small	5.8 x 4.3	45	up to 35
J0316s	Avalon Mahogany Urn, med	7.4 x 5.2	70	35-65
J0316t	Avalon Mahogany Urn, large	8.4 x 5.8	130	65-120
J0317a	Crouching Cat Urn - Calico	9.7 x 3.9	35	up to 30
J0317b	Crouching Cat Urn - Patina	9.2 x 4.6	35	up to 30
J0317c	Tall Cat Urn - Antique Bronze	9.2 x 4.6	40	up to 35
J0317d	Sitting Cat Urn - Calico	9.7 x 3.9	40	up to 35





J0316sph

J-016spL, spm, sps



J0316dph



J0316dpL, dpm, dps



Description	Dimensions (in inches)	Capacity (cubic inches)
J0316sph Slate/Pewter Single Paw Heart	2.9 x 2.9 x 2.7	3c.i.
J0316dph Pewter/Brass Double Paw Heart	2.9 x 2.9 x 2.7	3c.i.
J0316spL Slate/Pewter Single Paw Odyssey	5.8 x 5.8 x 4.5	70c.i.
J0316spm Slate/Pewter Single Paw Odyssey	4.9 x 4.9 x 3.5	40c.i.
J0316sps Slate/Pewter Single Paw Odyssey	4.3 x 4.3 x 3.3	25c.i.
J0316dpL Pewter/Brass Double Paw Odyssey	5.8 x 5.8 x 4.5	70c.i.
J0316dpm Pewter/Brass Double Paw Odyssey	4.9 x 4.9 x 3.5	40c.i.
J0316dps Pewter/Brass Double Paw Odyssey	4.3 x 4.3 x 3.3	25c.i.
J0316pbL Birch Finish Wood Photo Box	4.9 x 4.8 x 6.5	85c.i.
J0316pbm Birch Finish Wood Photo Box	4.3 x 4.0 x 5.8	40c.i.
J0316pbs Birch Finish Wood Photo Box	3.6 x 3.4 x 5.0	25c.i.
J0316pcL Cherry Finish Wood Photo Box	4.9 x 4.8 x 6.5	85c.i.
J0316pcm Cherry Finish Wood Photo Box	4.3 x 4.0 x 5.8	40c.i.
J0316pcs Cherry Finish Wood Photo Box	3.6 x 3.4 x 5.0	25c.i.
J0316pfL Black Finish Wood Photo Box	4.9 x 4.8 x 6.5	85c.i.
J0316pfm Black Finish Wood Photo Box	4.3 x 4.0 x 5.8	40c.i.
J0316pfs Black Finish Wood Photo Box	3.6 x 3.4 x 5.0	25c.i.



J0316pbL, pbm, pbs



J0316pcL, pcm, pcs



J-016pfL, pfm, pfs



Silhouette Cat Urn Series. Beautiful brass urns with 4 brass inlays of cat silhouettes around the body of the urn. Holds up to 30 cubic inches, large enough for any cat up to 30lbs.

- J0316fs Fern Silhouette Cat Urn
- J0316hs Shale Silhouette Cat Urn
- J0316ss Sienna Silhouette Cat Urn
- J0316cbs Country Blue Cat Urn



**Paw Print Classic Pet Pewter Urns.** These urns are handcrafted in brass with a pewter finish and gold paw print inlays that encircle the urn. Threaded lid for tight seal.

	Capacity	Pet Wt.
J0316ppps Paw Print Classic Pewter Urn—Small	85 cubic in	35–65lbs
J0316pppxs Paw Print Classic Pewter Urn—Xsmall	40 cubic in	16–35lbs
J0316pppp Paw Print Classic Pewter Urn—Petite	25 cubic in	1–15lbs
J0316ppph Paw Print Classic Pewter Urn—Heart Shape	3 cubic in	



**Paw Print Classic Pet Brass Urns.** These urns are handcrafted in brass with black color paw print inlays that encircle the urn. Threaded lid for tight seal.

	Capacity	Pet Wt.
J0316pps Paw Print Classic Brass Urn—Small	85 cubic in	35–65lbs
J0316ppxs Paw Print Classic Brass Urn—Xsmall	40 cubic in	10–35lbs
J0316ppp Paw Print Classic Brass Urn—Petite	25 cubic in	1–15lbs
J0316pph Paw Print Classic Brass Urn—Heart Shape	3 cubic in	



**Paw Print Classic Pet Slate Urns.** These urns are handcrafted in brass with a slate finish and pewter paw print inlays that encircle the urn. Threaded lid for tight seal.

	Capacity	Pet Wt.
J0316psl Paw Print Classic Slate Urn—Large	195 cubic in	up to 190 lbs
J0316psm Paw Print Classic Slate Urn—Medium	85 cubic in	up to 80lbs
J0316pss Paw Print Classic Slate Urn—Small	40 cubic in	up to 35lbs
J0316psx Paw Print Classic Slate Urn—XSmall	25 cubic in	up to 20lbs
J0316sph Paw Print Classic Slate Urn—Heart Shape	5 cubic in	



- J0316hstg Heart Stand—Antique Bronze
- J0316hstp Heart Stand—Pewter

**Faux Bronze Urns.** These faux bronze urns give an upscale look at an affordable price. A special lightweight polymer gives these urns a realistic bronze appearance.

- J0317x Canine with angel wings. Capacity 40 lbs.
- J0317y Feline with angel wings. Capacity less than 15 lbs.





**Peaceful Pets Body Transfer Bag.**

**For Transportation, Cremation, or Home Burial.** This is the professional and respectful way to return deceased pets to their owners. The Peaceful Pets body transfer bag is a simple and attractive designed case. It can be used to transport a deceased patient to a pet crematory, cemetery, or home burial. The animal can be viewed if so desired in a dignified setting.

- Pet is wrapped in double layer quilted fabric
- Surface layer 20% cotton/80% polyester; Lining 100% polyester.
- Removable inner absorbent and water proof liner pad lies in a hidden inner pouch
- Available in four different sizes
- Black ribbon ties in an attractive bow.

- J1234** Peaceful Pets Bag, 15"x10"x4", up to 8lbs
- J1234a** Peaceful Pets Bag, 20"x14"x4", up to 20lbs
- J1234b** Peaceful Pets Bag, 25"x18"x4", up to 30lbs
- J1234c** Peaceful Pets Bag, 36"x22"x4", up to 60lbs
- J1234s** Peaceful Pets Bag, set of all four

**NEW**



**J1234 series**

**The step by step process:**

**Open initially**



**Pouch for animal**



**Place animal in pouch**



**Notice Absorbent liner**



**Closed position**



**Tie off with ribbon**



JorVet offers a fun variety of jewelry that provides the chance to show pride in your profession.

**Veterinary Technician.** Sold as set of earrings and lapel pin or separately.

**Black with Gold Enamel**  
**J1301** Set of earrings and lapel pin  
**J1301e** Earrings only  
**J1301p** Lapel pin only

**Blue with Silver Enamel**  
**J1302** Set of earrings and lapel pin  
**J1302e** Earrings only  
**J1302p** Lapel pin only

**Black and Red with Gold**  
**J1303** Set of earrings and lapel pin  
**J1303e** Earrings only  
**J1303p** Lapel pin only

**Veterinary Caduceus.** Sold as set of earrings and lapel pin or separately.

**Black with Gold Enamel**  
**J1308** Set of earrings and lapel pin  
**J1308e** Earrings only  
**J1308p** Lapel pin only

**Blue with Silver Enamel**  
**J1309** Set of earrings and lapel pin  
**J1309e** Earrings only  
**J1309p** Lapel pin only

**Black and Red with Gold**  
**J1310** Set of earrings and lapel pin  
**J1310e** Earrings only  
**J1310p** Lapel pin only

**Dog Paw Silver and Black Enamel**  
**J1304** Earrings and pendant (chain not included)  
**J1304e** Earrings only  
**J1304p** Pendant only (chain not included)

**Dog Paw Silver with Rhinestones**  
**J1307** Earrings and pendant (chain not included)  
**J1307e** Earrings only  
**J1307p** Pendant only (chain not included)

**Dog Bone Silver with Rhinestones**  
**J1306** Earrings and pendant (chain not included)  
**J1306e** Earrings only  
**J1306p** Pendant only (chain not included)



**NEW**

**PURR Muzzle for Cats.** With a Transparent Cone and Neck Restraint Flap To Visualize Mouth Teeth and Perform Clinical Procedures on Restrained but Relaxed Cats

**Safety and Protection.** The use of a nylon muzzle is a common everyday necessity in a veterinary practice. Feline Patients can be upset, frightened, and even vicious. However, standard nylon muzzles block access to the oral cavity; and cats are often able to remove them with their front legs. Most cat muzzles available today block the cat's and the veterinarian's vision; upset the cat, and provide little restraint.

The **PURR-Muzzle** was developed by a practicing veterinarian to solve these problems. A restraint flap that wraps around the neck of the cat is available in 4 rather than 3 sizes. It is essential in keeping the see-through cone on the face and also works to relax most cats for minutes thereby allowing for clinical examination and procedures. The see-through cone allows one to examine the eyes such as pupillary response and by means of an opening in the mouth area allows one's finger to pull the lips away so that the gums can be evaluated. The cone of the properly fitted muzzle will keep the mouth clinched while the patient's gums and most teeth can be evaluated.

Velcro straps keep the cone placed firmly on the face while connected to the restraining flap that is around the neck.

- Assess parameters such as gum color and capillary refill
- Assess possible dental problems
- Give oral treatments such as emergency poisonings
- Restrain the cat patient
- Relax the cat patient

The Purr-Muzzle was developed by a veterinarian. It's acronym stands for the Perfected Utilization of Restraint and Relaxation.

Sizes given are recommendations only:

- J1346a**    **Size 1:** kittens of 10 weeks to 14 weeks
- J1346b**    **Size 2:** kittens older than 14 weeks to 6 months
- J1346c**    **Size 3:** Cats older than 6 months and less than 1 year.
- J1346d**    **Size 4:** Cats typically older than 1 ½ years and big breeds (maine coon and hefty cats)
- J1346s**    **Set** of all 4

PURR-Muzzle® Patent Pending

*Caution: The use of any muzzle still has the risk of injury*



THIS CAT IS RELAXED BY THE MUZZLE WITHOUT DRUGS  
BLOOD DRAW IS EASIER AND SAFER

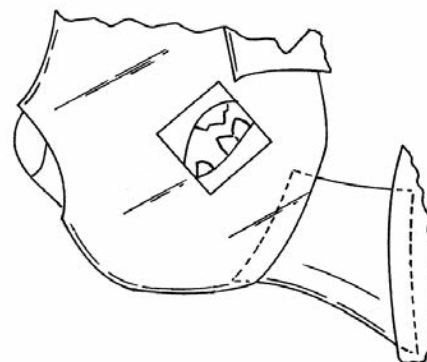
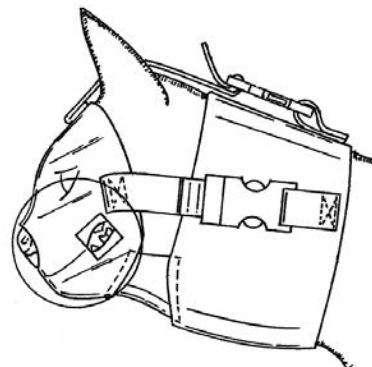



## A

Ace bandages	254
Acid-Fast stain	281
Acupuncture Charts	391
Acupuncture Models	390
Acupuncture Needles	390
Adhesive tape	255
Aesculap instruments	85
Alcohol jar	361
Alligator forceps	79
Ameroid Constrictors	267
Anal sac kit	267
Anatomical models	351
Anchor, suture	246
Anesthesia	
Bags	135
Chamber	132
Circuit	133
Circuit Filler	132
Connectors	138–140
Hose adaptor/connector	143
Machines	144–145
Machine: Easy Flow	144
Masks	134
Scavenger	133
Angiotribe, Fergusson	77
Anticoagulants	113
Anti-kick clamps	58
Anti-Lick Strips	259
Anti-spill funnel/adaptor	148
Apparel, OB	27
Applicator sticks	251
Apron	70, 342, 344
Aspir gun	118
Artery forceps, Jones	266
Arthrodesis plates	
Carpal	226
Pantarsal	226
Arthroplasty rasp	197
Arthroscopy Hand Infrnr	246
Arthroscopy Hand Instruments	246
Artificial insemination kit	24
Artificial insemination pipettes	24
Artificial vagina, equine	25
Aspiration unit	352
Autoclave Cleaner	275
Avian	
Endotracheal tube	129
Oral speculum	321
Positioner	320
Restrainer	320
Drape	325

## B

Bag, Anesthesia	134
Balfour retractor	83
Balling gun	261
Balling gun, multidose	261
Bandages	254–255
Barium Sulfate	347
Beakers, three-corner	305
Beasley Babcock forceps	82
Beds, Anti-Slip	386
Beds, Buster Comfort	386
Behavior Training	394–395, 402
Behney ear instrument	245
Biohazard	
Disposal	388–389
Eye wash system	388
Biopsy	
Cassette	308
Forceps, soft tissue	116
Forceps, uterine	117, 118
Needle, bone	115, 118
Needle, aspiration	115
Skin	117
Bipolar electrosurgery	331–332
Bird collars	63
Bleeding needles	108
Bloat trocars	32, 33
Blood	
Collection Bags	111–112
Collection Tray	114, 288
Filter	117
Pressure cuffs	330
Pressure monitor	330
Test strips	296
Rocker	296
Stains	280–281
Time Devices	114
Transfusion bags	111–112
Transfusion set	111–112, 114
Tube rack	279
Blankets, warming	377
Body wear	69
Bone	
Biopsy instruments	115
Cement	207
Chisel	195
Curette	196
Cutting forceps	196
Epoxy Putty	207
Fragment clamp	189
Holding forceps	188–190
Mallet	197
Pin cutters	193
Pin gauge	228
Pin introducer	204
Pin Point covers	201

Plate benders	192
Plate clip	228
Plate pliers	193
Plate press	193
Plates	211–228
Plate kits	210, 214, 216–217
Rasp	197
Saw	190, 227
Screws	212–225
Toggle	191, 236
Tunnel Borers	233
Washers	192
Wax	228
Bone marrow biopsy	115
Boot, protective canine	362
Boots, cow	54
Boots, disposable plastic	28
Bottle Adaptor	99
Bottle closures	359
Bottles	
Amber Dropper	363
Amber Glass	364
Amber Plastic	364
Boston Round	363
Bottoms Up Harness	366
Bowls	
Disposable, water & food	382
Feeding	323
Maze	273
Bos® lower leg splint	180
Brace, Jorvet Pet	180
Breathe Easy,® feline	153
Breath Fresh canister	136
Breathing bags	135
Breeding bag	25
Broncho-Alveolar catheter	36
Brown gauze	251
Brushes,	
surgical cleaning	90
Bucket	322–323
Buhner needle & tape	22
Bulb syringe	90
Bull	
Leads	265
Rings	265
Bullpen® IV warmer	105
BUN Strips	296
Bunsen burners	297
Burial boxes	396
Burette, IV	93
Buster® cube	272
Buster® collars	63–65
Buster® Rabbit collar	64
Button, Toggle	33

## C

- Cadaver bags . . . . . 396  
 Caesarean forceps . . . . . 18  
 Cage Caddy . . . . . 384  
 Cage card holders . . . . . 378  
 Cage racks . . . . . 383  
 Calculus removal forceps . . . . . 159  
 Calf  
   Drencher . . . . . 262–264  
   Hercules® calf puller . . . . . 21  
   Nipple . . . . . 261  
 CalGel® . . . . . 278  
 Camera, Omnivid . . . . . 292  
 Cancellous screws . . . . . 214–218  
 Canine icers . . . . . 369  
 Cannulated Infusion Screw kit . . . . . 203  
 Cap extractor . . . . . 48  
 Capillary  
   Tubes . . . . . 301  
   Sealant . . . . . 301  
   Plastic . . . . . 301  
 Cap, syringe . . . . . 17  
 Carpal  
   Arthrodesis plate . . . . . 226  
   Splints . . . . . 181  
   Wrap . . . . . 368  
 Cart, mobility . . . . . 365  
 Cartilage scissors . . . . . 79, 244  
 Carriers, pet . . . . . 75  
 Cassette tunnel . . . . . 39  
 Cast  
   Cutter, electric . . . . . 230  
   Cutter, Engel . . . . . 230  
   Fiberglass . . . . . 255  
   Padding . . . . . 255  
   Spreader . . . . . 230  
 Casting tape . . . . . 253  
 Castration kit . . . . . 35  
 Castroviejo  
   Fixation forceps . . . . . 174  
   Needle holder . . . . . 174  
 Catchers, dog and cat . . . . . 60  
 Catmosphere . . . . . 272  
 Cat restrainers . . . . . 60, 73  
 Catheter  
   Adapter . . . . . 122  
   Broncho-Alveolar . . . . . 36  
   Canine urinary . . . . . 123  
   Centesis . . . . . 316  
   Chamber . . . . . 36  
   Feline Barium . . . . . 121  
   Guttural pouch . . . . . 36  
   Jackson® cat catheter . . . . . 121  
   Stallion . . . . . 119  
   Tomcat . . . . . 122, 124  
   Urinary . . . . . 119–121  
   Uterine . . . . . 119  
 Cath Link LL adaptors . . . . . 12  
 Cautery, portable . . . . . 333  
 Cell counters . . . . . 288–289  
 Central Venous Catheter . . . . . 105  
 Centrifuge  
   Centrifuges . . . . . 283–285  
   Portable . . . . . 286  
   Tubes . . . . . 302  
 Cerclage  
   Button . . . . . 206  
   Wire . . . . . 206  
   Wire passer . . . . . 205  
   Wire tightener . . . . . 206  
 Chain handles, OB . . . . . 20  
 Chains, OB . . . . . 20  
 Chamber catheter . . . . . 36  
 Charcoal canisters . . . . . 136  
 Cheek Retractor, Hickey . . . . . 48  
 Chemo Protect Vial Venting System . . . . . 388  
 Chiba style needle . . . . . 117  
 Chuck  
   Jacobs . . . . . 229  
 Clamp  
   Condyle . . . . . 188  
   KE . . . . . 199  
   Lowman Bone . . . . . 188  
   Meniscus . . . . . 234  
 Cleaning brush, surgical . . . . . 90  
 Clippers,  
   Hauptner® hand . . . . . 265  
   CMT . . . . . 29  
 Collars  
   Avian . . . . . 63  
   Buster® bird . . . . . 63  
   Buster® Comfort . . . . . 65  
   Buster® dog . . . . . 63–65  
   Buster® Disc . . . . . 65  
   Clear collar . . . . . 64  
   Clic collar . . . . . 64  
   Flex collar . . . . . 65  
   Foam . . . . . 66  
   Rabbit . . . . . 64  
   Soft-E . . . . . 65  
 Colostrum Plus® . . . . . 278  
 Colostrumeter  
   Equine . . . . . 37  
   Bovine . . . . . 278  
 Comb/Dematter . . . . . 318  
 Comb, dog & cat . . . . . 318  
 Comfort collar, Buster . . . . . 65  
 Comfort Pads . . . . . 385  
 Compression Plates . . . . . 212–218  
 Compression Bone Plate Kits . . . . . 214  
 Condoms, equine . . . . . 25  
 Condyle clamp . . . . . 188  
 Copenhagen Reduction Assistant . . . . . 215  
 Coplin jar . . . . . 281  
 Cortical nuts . . . . . 228  
 Cortical Self-tapping Plate Kit . . . . . 216  
 Cortical screws . . . . . 214–219  
 Cots, Colorado Pets . . . . . 385  
 Cotton  
   Applicators, cotton tip . . . . . 251  
   Balls . . . . . 252  
   Roll . . . . . 253  
   Sheeting . . . . . 256  
 Counter sink . . . . . 188  
 Cover slip, slides . . . . . 298  
 Cremation urns . . . . . 396–397  
 Crimp tubes . . . . . 231  
 Crimper, double action . . . . . 231  
 Crit carrier . . . . . 283  
 Cruciate  
   Crimp tubes . . . . . 231–233  
   Needles . . . . . 231  
   Repair system . . . . . 231–233  
   Staple . . . . . 244  
   Starter kit . . . . . 233  
 Cryosurgery . . . . . 355–356  
 Cube, Buster® . . . . . 272  
 Cuff, endo tube repair . . . . . 129  
 Culture  
   Swabs . . . . . 24  
   Tubes . . . . . 303  
 Cutter, finger ring . . . . . 79

## D

- DA needles . . . . . 32  
 DA toggle button . . . . . 33  
 DA toggle suture . . . . . 33  
 DCP and screw kit 2.4mm . . . . . 216  
   compression plates . . . . . 215–220  
   cortical screws 2.7mm . . . . . 217  
   drill pilot . . . . . 214  
   screw box . . . . . 214  
 DeBakey forceps . . . . . 82  
 Declaw forceps . . . . . 275  
 Dehorners . . . . . 266  
 Delta TPLO plates . . . . . 236–238  
 Dental  
   Burr block . . . . . 158  
   Burrs and disks . . . . . 169–170  
   Elevators . . . . . 159–162  
   Elevators, Comfort Handle . . . . . 159  
   Face and Eye Shield . . . . . 171–172  
   Floats . . . . . 42–44  
   Halter . . . . . 45  
   Inserts . . . . . 169–170  
   Irrigation pick, equine . . . . . 51  
   Instruments  
   Equine . . . . . 42–51  
   Small animal . . . . . 155–163  
   Rodents . . . . . 163–165  
   Swine . . . . . 20  
   Picks, equine . . . . . 51  
   Plaque disclosing system . . . . . 169  
   Polisher . . . . . 165–169  
   Portable water tank . . . . . 168

Prophy kit	155
Prophy pack	157
Scrapers	157–159
Trays	157–158
Ultrasonic scaler	166–168
Water line connections	169
Wedge	161
Depth gauges	187
Detergent, instrument cleaning	91
Detorsion rod	22
Diaper Wraps	366
Differential cell counter	288–289
Disinfectant solutions	338
Dispensing Bins	384
Disposal	
Biohazard	388
Hypodermic needle	16
Waste bags	388
Disposable	
Bowls, water & food	382
Litter pans	382
Dog collars, Buster	63–65
Dog collars, Soft-E	65
DogLeggs, Disc.	180
Dog poles	60
Doppler unit	330
Dorsi-flex splints	369
Dose	
Adaptor	17
Syringe	14
Doyen forceps	78
Drager vaporizer	147
Drainage catheter, Pig Tail	316
Drains, Penrose	339
Drape	
Adhesive	326
Impervious	326
Surgical	326–329
Drapes and Surgical Gowns, Equine	329
Drench	
Calf	262
Drenchers	14–15, 264
Pump	312
Sheep/Goat kit	14
Dressing jars	320
Drill	
Bits	202, 209
Case	210
Guides	187, 191
Power	229
Shroud	229
Stop kit	209
Droplet blood collection tray	288
Dropper	
Bottles, amber	364
Eye	357
Medicine	357
D-Vid Handheld Digital Microscope	299
Dynamic external fixator	199

## E

E-tank holder	151
E-tank yoke	144
Ear	
Cotton swabs	251
Crop instruments	247
Curette, Buck	247
Curette, Billiau	247
Instrument, Behney	247
Syringe	90
Tags, mouse	341
Wax Eater	249
Ear Wick	250
ECG machine	329
Ecobag Dispenser	378
Ecrasseur	35
EKG monitor	329
Elastome tube	339
Elastrator and bands	34
Eld gastrostomy applicator	311
Eldridge mask	134
Electrosurgical unit	331–332
Emasculatomes	35
Emasculators	34–35
Embryotomy knives	18
Emergency & Critical Care Cart	337
Endolight system	130
Endoscope storage trays	335
Endotracheal	
Tubes	126–129
Tube, avian	126–129
Tube, equine	126–129
Tube rack	135
Tube, swine	129
Endotube clean brush	130
Endotube connectors	130
Endotube stylet	130
Enteral Feeding Products	314
Enteral Fluid Therapy Set - Equine	38
Enzymatic	
instrument cleaner	91
Epoxy putty	207
Equine	
Dental forceps	48–49
Leg wraps	256
Haler	38
Ocular lavage kit	178
Recovery Hood	38
Esmark bandage	90
Esophageal	
forceps	275
stethoscope	132
tube insertion device	310
Esophagostomy tube	309
Evans mobility cart	365
External fixation	
equipment	199–202
Extractor, dental kit	160

Eye	
Eye dropper	357
Eye hooks	19
Eyelid retractors	174
Eye Saver™, equine	178
Eye wash system	388
Eye shield	171
Eyewear, protective	160
Ewe prolapse retainer	22
External Stifle Retractor	243
EZ Hanger Instrument Holder	84
EZ lift harness	371
EZ swallow stomach tubes	317
EZ tie	128

## F

“F” circuit	132
Face and eye shield	170
Farrowing	
Forceps	20
Snare	20
Faucet adapter, touchless	265
Fecal	
Assay kit – equine	302
Assay kit – ruminant	302
Assay kit – small animal	302
Fat stain	278
Filters	284
Filter, micron disc	113
Floatation solution	284
Loops	68
Ova float	68
Test, Squeeze test	306
Feeding	
Bowls	321
Bowls, disposable	377
Needles	319
Tubes	306, 310
Feline Breathe Easy	152
Femoral head disarticulator	231
Ferret	
Cryoprobe	351
Mouth gag	59
Muzzle	72
Ferromatic syringe	12
Fessa Tubular Fixation System	200
Fetal extractor, Hercules®	21
Fetatomes	18
Fiberglass cast	251
Finger ring cutter	79
Filter, anesthetic	131
Finochietto retractors	83
Finochietto rib spreader	83
FitPaws	369–370
Fixation	
Clamps	199–201
Pins	199–201
Rods	199–201



- Flea Combs . . . . . 318  
 Floats  
   Blades . . . . . 42–44  
   Floats . . . . . 42–44  
 Fluid Therapy kit, equine . . . . . 38  
 Fluid (IV) Warmers . . . . . 105  
 Fluoro-Dot light . . . . . 174  
 Foam collar . . . . . 66  
 Foley catheters . . . . . 313–314  
 Foot rot shears . . . . . 53  
 Forceps  
   Alligator . . . . . 79  
   Allis tissue . . . . . 81  
   Bone cutting . . . . . 196  
   Bone holding . . . . . 188–190  
   Brown Adson® . . . . . 82  
   Canine, OB . . . . . 20  
   Crile . . . . . 77  
   Doyen . . . . . 78  
   Graefe® . . . . . 176  
   Halstead (mosquito) . . . . . 77  
   Jones artery . . . . . 266  
   Kelly . . . . . 77  
   Lucae . . . . . 82  
   Magill intubation . . . . . 131  
   Plate holding . . . . . 188  
   Reduction . . . . . 190  
   Rochester Carmalt . . . . . 78  
   Russian . . . . . 82  
   Sow, OB . . . . . 20  
   Sponge . . . . . 81  
   Thumb . . . . . 82  
   Tissue . . . . . 82  
   Tongue . . . . . 84  
   Uterine biopsy . . . . . 118  
   Wolftooth . . . . . 47  
 Foreign body retriever . . . . . 275  
 Formalin jar . . . . . 308  
 Fragment bone forceps . . . . . 189  
 Franseen style needle . . . . . 117  
 Frazier suction . . . . . 352  
 Freemartin probe . . . . . 23  
 Freer elevator . . . . . 196  
 Frick speculum . . . . . 58  
 Fulcrum, dental . . . . . 51  
 Funnel/Adaptor, anti-spill . . . . . 148  
 FUS needles . . . . . 122
- G**
- Gas scavenger . . . . . 136–137  
 Gastric lavage kit . . . . . 267  
 Gastrosopes . . . . . 61  
 Gastrostomy Feeding tubes . . . . . 311  
 Gastrostomy tube applicator . . . . . 311  
 Gauge, bone pin . . . . . 228  
 Gauze  
   Bandage . . . . . 251–252  
   Brown “Cling” . . . . . 251
- Sponge . . . . . 251–252  
 Tubes . . . . . 252  
 Gel cast . . . . . 256  
 Gelpi retractor . . . . . 83  
 General surgery drape packs . . . . . 326  
 Gerlach® needle . . . . . 22  
 Gigli wire & handles . . . . . 197  
 Gingival elevator, equine . . . . . 50  
 Glaucoma instruments . . . . . 175–177  
 Gloves  
   Box holder . . . . . 307  
   Grooming . . . . . 319  
   OB plastic . . . . . 27–28  
   Restraint . . . . . 74  
 Glucose strips . . . . . 296  
 Goggles, safety . . . . . 300  
 Goniometer . . . . . 373  
 Goniometer, surgical . . . . . 244  
 Graft passer . . . . . 245  
 Gram stain . . . . . 292  
 Graspers, cat . . . . . 60  
 Grooming Equipment . . . . . 318–319  
 G-tube Holder . . . . . 307  
 Guttural pouch catheter . . . . . 36  
 Guttural pouch swab . . . . . 36
- H**
- Hall air mask . . . . . 134  
 Halter, dental . . . . . 45  
 Halti Dog collar . . . . . 68  
 Halti Harness . . . . . 68  
 Handles  
   OB chain . . . . . 20  
   OB wire . . . . . 18  
   Scalpel . . . . . 86  
 Handy Tech pet parking system . . . . . 66  
 Harness  
   EZ lift . . . . . 371  
   Walkabout™ . . . . . 371  
   Webmaster . . . . . 365  
 Hatt spoon . . . . . 196  
 Hauptner® syringe . . . . . 13  
 Headlamp . . . . . 46, 257–270  
 Healing plates . . . . . 228  
 Heart model . . . . . 351  
 Heimlich one-way valve . . . . . 340  
 Hemacytometer . . . . . 291  
 Hemostatic Products . . . . . 259–260  
 Hemostop . . . . . 269  
 Hematoma pad . . . . . 274  
 Hemo Nate filter . . . . . 114  
 Hemostats . . . . . 77  
 Hemostatic clips . . . . . 88  
 Hemo-Tap spike . . . . . 114  
 Hernia clamps . . . . . 266  
 Hetastarch . . . . . 113  
 Hickory Equine  
   Dental Cheek Retractor . . . . . 48
- Hip Hohman . . . . . 245  
 Hobble straps, bovine . . . . . 58  
 Hog Holder . . . . . 266  
 Hohman refractor . . . . . 245  
 Holder  
   Glove box . . . . . 307  
   Kim Wipe® box . . . . . 307  
 Hood, equine recovery . . . . . 38  
 Hoof  
   Acrylic hoof . . . . . 54  
   Hugh’s hoof groover . . . . . 53  
   Knives . . . . . 52–53  
   Testers . . . . . 55  
   Trimmers . . . . . 56  
 Hoof Sock, Tubbease . . . . . 56  
 Humid Vent . . . . . 143  
 Humidifier . . . . . 148  
 Hydrometer . . . . . 37, 284  
 Hypodermic needles . . . . . 16  
 Hypothermia prevention system . . . . . 368
- I**
- ICU Cage . . . . . 152  
 Immersion oil . . . . . 281  
 Incisor speculum, equine . . . . . 46  
 IncrediBowls . . . . . 383  
 Incubator . . . . . 287  
 Indwelling uterine catheter . . . . . 119  
 Infusion pump . . . . . 102, 108  
 Inoculating loop . . . . . 297  
 Insemination . . . . . 26  
 Indirect viewing lens . . . . . 177  
 Infusion set . . . . . 103  
 Infusion syringe pump . . . . . 103  
 Inhaler, equine . . . . . 38  
 Inhaler, feline . . . . . 134  
 Intermedullary Pins, hand chuck . . . . . 198  
 Instrument  
   Cleaner, enzymatic . . . . . 91  
   Guards . . . . . 89  
   ID tape . . . . . 87  
   Milk . . . . . 91  
   Rack . . . . . 84  
   Trays . . . . . 322  
 Intramedullary pins . . . . . 198  
   IM bone pin tube . . . . . 198  
 Intraosseous needle . . . . . 118  
 Intravenous (IV)  
   Bag Spike . . . . . 113  
   Bullpen® IV warmer . . . . . 105  
   Burette, IV . . . . . 93  
   Cage-mount holder . . . . . 107  
   Catheters . . . . . 101  
   Needles . . . . . 108  
   Pressure infuser . . . . . 100  
   Mini drop set . . . . . 94  
   Sets . . . . . 92–97  
   Solution bags . . . . . 108

Splint, Cochran® . . . . . 107  
 Stand . . . . . 100  
 Thermal I.V. . . . . 105  
 Track system . . . . . 110  
 Intubation forceps . . . . . 131  
 Iodine stain . . . . . 280  
 IRAP equipment . . . . . 285  
 Irrigation cannula . . . . . 176  
 Isolation Gowns . . . . . 343  
 IV Catheter Guard . . . . . 100  
 IV connections . . . . . 98  
 IV extension sets . . . . . 94–97  
 IV pump . . . . . 102  
 IV sets, large bore . . . . . 109

## J

Jackson cat catheter . . . . . 121  
 Jacob chuck . . . . . 229  
 Jewelry, veterinary design . . . . . 401  
 J-Jelly lubricant . . . . . 23  
 J-Lube lubricant . . . . . 23  
 Jugular Catheter, Equine . . . . . 104

## K

Kat Kath catheter . . . . . 124  
 K-9 Float Coat . . . . . 353  
 KE clamps  
 Standard . . . . . 199–202  
 Starter kit . . . . . 199  
 Tissue protector . . . . . 202  
 Kennel mattress . . . . . 152  
 Kennel pads, absorbent . . . . . 383  
 Kerns bone forceps . . . . . 189  
 Ketch All poles . . . . . 60  
 Ketogel® . . . . . 278  
 Ketone strips . . . . . 283  
 Kick bucket . . . . . 321  
 Kim Wipe® holder . . . . . 308  
 Kitty Kollar . . . . . 310  
 Knives  
 Fetotomy . . . . . 18  
 Hoof . . . . . 52–53  
 Necropsy . . . . . 277  
 Sharpeners . . . . . 277  
 K-wire  
 Bender . . . . . 198  
 Cutter . . . . . 203  
 Dispenser . . . . . 197  
 Extraction Forceps . . . . . 198  
 Small pin punch . . . . . 198  
 K-wire . . . . . 198

## L

Lab, coat . . . . . 342  
 Lab, litter . . . . . 125  
 Lacrimal

Cannula . . . . . 176  
 Cannula, equine . . . . . 176  
 Needles . . . . . 176  
 Lambing aid . . . . . 22  
 Landing Cots . . . . . 385  
 Laparotomy sponges . . . . . 251  
 Laser, machine . . . . . 392–393  
 Laserpointers . . . . . 40  
 Laser, parts . . . . . 276  
 Laser Therapy . . . . . 392, 393  
 Laryngoscope . . . . . 131  
 Laryngoscope blades . . . . . 131  
 Leash, EZE holder . . . . . 66  
 Lectro kennel . . . . . 375  
 Leg ring cutter, avian . . . . . 320  
 Lesser wire passer . . . . . 205  
 Leukotic Plus . . . . . 302  
 Lift harness . . . . . 371  
 Liga Fiba fiber . . . . . 235–236  
 Light  
 Dental Lite . . . . . 46  
 Fluoro Dot . . . . . 174  
 Slit . . . . . 174  
 Litter, lab . . . . . 125  
 Litter Magnet . . . . . 125  
 Litter pans, disposable . . . . . 382  
 Locking hole plates . . . . . 223  
 Locking plate drill guide . . . . . 224  
 Locking plates . . . . . 224  
 Locking plate starter kit . . . . . 224  
 Locking screws . . . . . 223–224  
 Lone Star retractor . . . . . 264  
 Loupes, operating . . . . . 270  
 Lowman bone clamp . . . . . 188  
 Lubricants, OB . . . . . 23  
 Luccae forceps . . . . . 82

## M

Magic Beads . . . . . 349  
 Magill intubation forceps . . . . . 131  
 Magnets . . . . . 265  
 Male, adaptors . . . . . 93  
 Malecot catheter . . . . . 313  
 Mallet  
 Orthopedic . . . . . 197  
 Percussion . . . . . 84  
 Manuka dressing . . . . . 257  
 Marker, surgical skin . . . . . 87  
 Mare urinary catheter . . . . . 120  
 Mask valve . . . . . 143  
 Mason cruciate line . . . . . 233  
 Mason Meta metal splints . . . . . 181  
 Mastitis test kit . . . . . 29  
 Mats . . . . . 381  
 Mayo stand . . . . . 323  
 Maze Bowls . . . . . 273  
 McIntosh® laryngoscope blade . . . . . 131  
 McPherson mouth gag . . . . . 45

Meniscus clamp . . . . . 243  
 Meniscus knife . . . . . 244  
 Meniscus probes . . . . . 234  
 Meniscus surgery kit . . . . . 234  
 Mesh restraint bag . . . . . 73  
 Meister speculum . . . . . 45  
 Mesh, surgical . . . . . 269  
 Meter, pH . . . . . 295  
 Michel clips . . . . . 88  
 Microalbumin Urine Test Strips . . . . . 296  
 Microcentrifuge tubes . . . . . 299  
 Microhematocrit  
 Centrifuge . . . . . 283  
 Tubes . . . . . 301  
 Microscope  
 Cleaning Kit . . . . . 294  
 Cover slips . . . . . 298  
 Microscope . . . . . 289–290  
 Organizer . . . . . 294  
 Semen evaluation . . . . . 292  
 Slides . . . . . 298  
 Slide holder . . . . . 299  
 Slide mailer . . . . . 298  
 Microscope, Inspector Zoom . . . . . 294  
 Milk tubes . . . . . 31  
 Miller laryngoscope blades . . . . . 131  
 Mini-vid camera . . . . . 293  
 Mini drop IV set . . . . . 93  
 Mobility cart . . . . . 365  
 Models, anatomical . . . . . 351  
 Molar cutter & forceps . . . . . 46, 50  
 Monopius suture . . . . . 7  
 Monosyn suture . . . . . 8  
 Mortar & pestle . . . . . 358  
 Mothering kit . . . . . 357  
 Mouth gags  
 Cattle . . . . . 58  
 Equine . . . . . 45  
 Ferret . . . . . 59  
 Small animal . . . . . 59  
 MSDS Pamphlet holder . . . . . 389  
 Multi-dose balling gun . . . . . 259  
 Muzzle, nylon basket . . . . . 72  
 Muzzles . . . . . 71–73  
 Muzzle, Purr for cats . . . . . 402

## N

Nail  
 Puller . . . . . 57  
 Trimmers . . . . . 279  
 Narcotic cabinet . . . . . 336  
 Nasogastric tubes . . . . . 309  
 Nasolacrimal catheter, equine . . . . . 316  
 Nasotracheal tube, equine . . . . . 129  
 Navicular stand, Redden . . . . . 41  
 Nebulizer . . . . . 153  
 Necropsy knives . . . . . 277

- Needles
- Acupuncture . . . . . 390
  - Biopsy . . . . . 116
  - Bleeding . . . . . 108
  - Blunt tip . . . . . 17
  - DA . . . . . 32
  - Disposable . . . . . 16
  - Feeding . . . . . 321
  - Franseen style . . . . . 116
  - FUS . . . . . 122
  - Gerlach® . . . . . 22
  - Hypodermic . . . . . 16
  - Intravenous . . . . . 108
  - Lacrimal . . . . . 176
  - Prolapse . . . . . 22
  - Spinal . . . . . 117
  - Suture . . . . . 9-10
  - Thunderbolt . . . . . 16
  - Transfer . . . . . 17
- Needle holders . . . . . 81, 86
- Needle rack . . . . . 9
- Newberry knife . . . . . 35
- New methylene blue stain . . . . . 283
- Nipple
- Calf . . . . . 261
  - Lamb . . . . . 261
- Nitrous oxide connectors . . . . . 138
- Nuts, cortical . . . . . 228
- Nye tourniquet . . . . . 70
- O**
- Obstetrical (OB)
- Apparel . . . . . 27
  - Chains & handles . . . . . 20
  - Forceps, canine . . . . . 20
  - Forceps, sow . . . . . 20
  - Hooks . . . . . 19
  - Sleeves
    - Plastic . . . . . 27–28
  - Snare . . . . . 23
  - Straps . . . . . 20
  - Wire . . . . . 18
  - Wire guide . . . . . 19
  - Wire handles . . . . . 19–20
- Occular lavage kit . . . . . 178
- Ohio-style connector . . . . . 142
- Ointment jars . . . . . 363
- Omnivid camera . . . . . 292
- Operating Loupes . . . . . 270
- Ophthalmic
- Forceps . . . . . 174
  - Implants . . . . . 177
  - Indirect viewing lens . . . . . 177
  - Needles, canulas . . . . . 176
  - Scissors . . . . . 174
  - Speculum . . . . . 174
  - Stain Strips . . . . . 173
- Ophthalmic surgery kit . . . . . 176
- Ophthalmoscope . . . . . 59
- Optivisor . . . . . 271
- Orthopedic
- Bone Chisels . . . . . 195
  - Bone Clamp . . . . . 188–190
  - Bone Curettes . . . . . 196
  - Bone Cutting Forceps . . . . . 196
  - Bone Holding Forceps . . . . . 188–190
  - Bone Plate Benders . . . . . 192
  - Bone Plate Press . . . . . 193
  - Bone Plate, TTA Forkless . . . . . 242
  - Bone Plates, TPLO . . . . . 237–238
  - Bone Rasps . . . . . 197
  - Bone Saw . . . . . 190
  - Bone Scriber . . . . . 241
  - Bone Tunnel Bores . . . . . 233
  - Bone Washers . . . . . 191
  - Bone Wax . . . . . 228
  - Cement . . . . . 207
  - Cerclage Wire . . . . . 206
  - Cerclage Wire Tightener . . . . . 206
  - Condyle Clamp . . . . . 188
  - Countersink . . . . . 188
  - Cruciate Repair . . . . . 231–233
  - Cruciate Repair, Mod Marquet . . . . . 244
  - Cruciate Starter Kit . . . . . 233
  - Cruciate Tensioning Clamp . . . . . 233
  - Drill adapter . . . . . 230
  - Drill Guides . . . . . 187, 191
  - Drill, Power . . . . . 230
  - Epoxy . . . . . 207
  - External Fixation . . . . . 199–200
  - Femoral Head Disarticulator . . . . . 234
  - Graft Passer . . . . . 233
  - IM Pin Hand Chuck . . . . . 198
  - Intermedullary Pins . . . . . 198
  - Iso Toggles . . . . . 191
  - Jacobs Chuck . . . . . 229
  - K-Wires . . . . . 195
  - K-Wire Dispenser . . . . . 197
  - Limb Suspension Stand . . . . . 192
  - Lowman Bone Clamp . . . . . 188
  - Mallet . . . . . 197
  - Mason Cruciate Line . . . . . 233
  - Meniscus Probe . . . . . 234
  - Meniscus Surgery Kit . . . . . 234
  - Models . . . . . 348
  - Needle Driver, Hvy Duty . . . . . 233
  - Osteotomes . . . . . 195
  - Periosteal Elevators . . . . . 194
  - Pin Cutters . . . . . 204
  - Plate Holding forceps . . . . . 188
  - Plates, Acetabular . . . . . 222
  - Plates, Arthodesis Carpal . . . . . 226
  - Plates, Arthodesis Pantarsal . . . . . 226–227
  - Plates, Biological Healing . . . . . 225
  - Plates, Compression . . . . . 220
  - Plates, Broad . . . . . 220
  - Plates, Distal Femur . . . . . 222
  - Plates, Locking . . . . . 223–225
  - Plates, Locking Plugs . . . . . 224
  - Plates, Reconstructional . . . . . 221
  - Plates, T-Plates . . . . . 221
  - Power saw . . . . . 229
  - Ronguers . . . . . 194
  - Screw and Drill Bit Gauge . . . . . 228
  - Screw drivers . . . . . 187
  - Screws, Cancellous . . . . . 214–219
  - Screws, Cortical . . . . . 214–216
  - Screws, Cortical Screw Nut . . . . . 228
  - Screws, Locking . . . . . 222–224, 234
  - Screws, self-tapping . . . . . 210–211, 216
  - Stifle Retractor . . . . . 243
  - Surgical pack . . . . . 191
  - Suture passer, push-pull . . . . . 236
  - Tap Handle/Sleeves . . . . . 188
  - Tibial Tuberosity Advancement . . . . . 239
  - TPLO gauge, caliper . . . . . 236
  - TTA cage forceps . . . . . 241
  - TTA cages . . . . . 241
  - TTA saw guide . . . . . 241
  - TTA washers . . . . . 240
  - Wedge Osteotomy gauge . . . . . 241
- Osteophyte Rasp . . . . . 238
- Osteotome . . . . . 195
- Osteotomy gauge . . . . . 244
- Osteotomy
- Plate, triple . . . . . 223
- Otoscope . . . . . 59, 247
- Ova float . . . . . 67
- Oxygen
- Alarm . . . . . 141
  - Cage . . . . . 152
  - Catheters . . . . . 150
  - Concentrator . . . . . 148
  - Flowmeter . . . . . 142
  - Hose connector . . . . . 138–139
  - Hose retrator . . . . . 141
  - Nasal cannula . . . . . 150
  - Manifolds . . . . . 141
  - Oxy Hood® . . . . . 150
  - Portable delivery . . . . . 151
  - Pressure regulator . . . . . 142
  - Regulator . . . . . 142
  - Supply, central . . . . . 141
  - Tank rack & cart . . . . . 151
  - Tubing . . . . . 150
- P**
- Pad protector . . . . . 376
- Pails, SS . . . . . 320
- Pantarsal plates . . . . . 227
- Peaceful Pets Body Transfer Bag . . . . . 400
- Penlight
- Disposable . . . . . 272
  - Halogen . . . . . 61
- Penrose drains . . . . . 339
- Percussion mallet . . . . . 84



Periodontal ligament knives . . . . . 160  
 Periodontal probe . . . . . 157  
 Periodontal ultrasonic insert . . . . . 168  
 Periosteal elevator . . . . . 194  
 Peritoneal dialysis kit . . . . . 310, 312  
 Peritoneal Taps, equine . . . . . 37  
 pH  
 Meter . . . . . 295  
 Paper . . . . . 295  
 Pet  
 Burial boxes . . . . . 396  
 Carrier . . . . . 75  
 Nurser . . . . . 357  
 Parking System . . . . . 66  
 Pet Piller . . . . . 358  
 Pet piller, Buster . . . . . 358  
 Pezzer catheter . . . . . 313  
 Pigtail Drainage Catheter . . . . . 316  
 Pig tooth nipper . . . . . 266  
 Pill  
 Case . . . . . 357  
 Counter . . . . . 362  
 Counting tray . . . . . 358  
 Crusher . . . . . 360  
 Envelope . . . . . 359  
 Pet Piller . . . . . 358  
 Splitter . . . . . 360  
 Pin Cutter . . . . . 204  
 Pink germicide . . . . . 337  
 Pins  
 Cutter . . . . . 204  
 Intramedullary . . . . . 198  
 Pearson raised thread . . . . . 202  
 Positive thread . . . . . 202  
 Pipette Bulbs . . . . . 258  
 Pipettes, disposable . . . . . 304  
 Pipettors . . . . . 304  
 Plates  
 Bone . . . . . 210–227  
 Healing . . . . . 228  
 Osteotomy triple . . . . . 223  
 Pantarsal arthrodesis . . . . . 224  
 Pole syringe . . . . . 76  
 Poles, dog . . . . . 60  
 Poole suction handle . . . . . 348  
 Pooper Scooper . . . . . 378  
 Pop-Off valve restrictor . . . . . 148  
 Portable O<sub>2</sub> therapy . . . . . 151  
 Positioner  
 Gel . . . . . 350  
 Stifle . . . . . 82, 190  
 Thoracic . . . . . 268  
 Positive thread pins . . . . . 202  
 Postmortem scissors . . . . . 277  
 Potassium Hydroxide stain . . . . . 277  
 Power Saw and Drill System . . . . . 230  
 Pressure infuser . . . . . 100  
 Probe director . . . . . 82  
 Procal Amine . . . . . 117

Prod, electric . . . . . 265  
 Prolapse  
 Needles . . . . . 22  
 Retainers . . . . . 22  
 Rings . . . . . 266  
 Tape . . . . . 235  
 Prolapse kit . . . . . 22  
 Protective Body Wear . . . . . 69  
 Pumps  
 Drench . . . . . 313  
 IV . . . . . 102-103  
 Stomach . . . . . 313  
 Water circulating . . . . . 373  
 Punch, dental . . . . . 50  
 Putty, ESF epoxy . . . . . 207

## Q

Quick read thermometer . . . . . 75  
 Quick-release tourniquet . . . . . 71  
 Quick-shot support arm . . . . . 40  
 Quick Splint® . . . . . 182

## R

Rack, blood tube . . . . . 282, 307  
 Radiograph viewing box . . . . . 349  
 Radiographic Marker Balls . . . . . 348  
 Radiographic positioner . . . . . 41  
 Rake, undercoat . . . . . 318  
 Rapid Splint System . . . . . 179–180  
 Reconstruction bone plates . . . . . 221  
 Recovery, equine hood . . . . . 38  
 Rectal prolapse rings . . . . . 266  
 Redden navicular stand . . . . . 41  
 Reduction forceps . . . . . 190  
 Refractometer . . . . . 295  
 Refrigerator storage box . . . . . 333  
 Rehab E-stimulant . . . . . 373  
 Rehab tape outcomes kit . . . . . 373  
 Respiratory monitor . . . . . 329  
 Restrainer, avian . . . . . 320  
 Restraint  
 Bag, mesh . . . . . 73  
 Gloves, leather . . . . . 74  
 Resuscitation bag . . . . . 132  
 Retractors  
 Alm . . . . . 83  
 Balfour . . . . . 83  
 DesMarres . . . . . 83  
 Eyelid . . . . . 174  
 Gelpi . . . . . 83  
 Gilles small tip . . . . . 83  
 Lone Star . . . . . 268  
 Senn-Mueller . . . . . 83  
 Stifle . . . . . 243  
 Weitlaner . . . . . 83  
 Retractable Scalpel Handle . . . . . 85  
 Reynolds tooth extractors . . . . . 48  
 Rib shear . . . . . 277

Roaring burrs . . . . . 36  
 Rocker,  
 Blood . . . . . 296  
 Test tube . . . . . 296  
 Rodent dental instruments . . . . . 162–164  
 Rongeurs . . . . . 50, 194  
 Roux syringe, Henke® . . . . . 12  
 Rumen Drench kit . . . . . 33  
 Rumen Collection System, Selekt . . . . . 33  
 Rumen Magnets . . . . . 265  
 Ryding hoof testers . . . . . 55

## S

Safe 'N Warm mats . . . . . 376  
 Safil® . . . . . 4, 6–7  
 Sample bags . . . . . 353  
 Scale, Equine Platform . . . . . 354  
 Scaler, ultrasonic dental . . . . . 166–168  
 Scales . . . . . 353–354  
 Scale floor stand . . . . . 353  
 Scalpel  
 Blades . . . . . 86  
 Disposable . . . . . 86  
 Handles . . . . . 86  
 Scavenging tube . . . . . 133  
 Schiötz tonometer . . . . . 177  
 Scissors  
 Bandage . . . . . 78  
 Steven tenotomy . . . . . 79  
 Stitch . . . . . 79  
 Surgical . . . . . 80  
 Screw Holding Forceps . . . . . 211  
 Scriber, bone . . . . . 241  
 Scrubs, surgical . . . . . 344–345  
 Self-tapping screw . . . . . 210–213  
 Semen  
 Evaluation microscope . . . . . 292  
 Stain . . . . . 280  
 Senn-Mueller retractor . . . . . 83  
 Sharps containers . . . . . 389  
 Seal breaker/Cotton puller . . . . . 355  
 Shearers, sheep . . . . . 265  
 Shedding blade . . . . . 317  
 Sheep/Goat drench . . . . . 14  
 Sheridan endotracheal tubes . . . . . 126  
 Sherman Self-Tapping plate . . . . . 210–214  
 Shoe puller . . . . . 56  
 Silicone  
 Endotracheal tubes . . . . . 129  
 Feeding tubes . . . . . 312  
 Lubricant . . . . . 14  
 Sinus Drill Kit . . . . . 37  
 Skin biopsy punch . . . . . 117  
 Skin marker . . . . . 87  
 Skin Stapler . . . . . 11  
 Slicker brush . . . . . 318  
 Slit light . . . . . 174  
 Snare, calf . . . . . 23  
 Soaking trays . . . . . 336

- Soap dispenser . . . . . 361
- Socks, Buster® dog . . . . . 367
- Soda Lime Cannister . . . . . 146
- Soft-E Collar . . . . . 65
- Soft Tissue Protector Sleeve . . . . . 188
- Spay
- Hooks . . . . . 84
  - Hook, Mini . . . . . 84
  - Scissors . . . . . 35
- Spay-neuter pack . . . . . 77
- Spay-neuter drape pack . . . . . 324
- Specimen container . . . . . 303
- Speculum
- Avian oral . . . . . 319
  - Meister . . . . . 45
  - Oral equine . . . . . 45–46
  - Vaginal . . . . . 58
- Speedy Calf Feeder . . . . . 263
- Spike washer . . . . . 245
- Spinal needle . . . . . 117
- Splint
- Bos® lower leg . . . . . 179
  - Jorvet pet brace . . . . . 183
  - Mason Meta metal . . . . . 179
  - Plastic . . . . . 179
  - Rods . . . . . 184
  - Quick . . . . . 183
  - Sam® . . . . . 183
  - Super Petite Spoon Splint . . . . . 184
  - Tail . . . . . 184
  - Thermoplastic . . . . . 185–186
  - Thomas-Schroeder . . . . . 184
- Spinal Brace . . . . . 372
- Splint rod bender . . . . . 184
- Sponge
- Bowl . . . . . 323
  - Gauze . . . . . 252
  - Laparotomy . . . . . 245
- Spring infusor . . . . . 99
- Spoons, soft-sided . . . . . 84
- Squeeze Jets . . . . . 31
- Squeeze Test . . . . . 306
- Stains, lab . . . . . 280–281
- Stallion catheter . . . . . 119
- Staple
- Cruciate . . . . . 244
  - Skin . . . . . 11
- Stat Tracker . . . . . 307
- Sterilization
- Pouches . . . . . 87
  - Solution . . . . . 338
  - Trays . . . . . 334–335
  - Tubing . . . . . 87
- Stethoscopes
- Esophageal . . . . . 132
  - Stethoscopes . . . . . 61–62
- Stifle Retractor . . . . . 243
- Stockinette . . . . . 186, 253
- Stomach pump . . . . . 315–317
- Stomach tube
- Canine . . . . . 312
  - Equine . . . . . 317
  - Speculum . . . . . 309
- Stone scoop . . . . . 84
- Stools, sitting . . . . . 387
- Stop-cock . . . . . 99, 109
- Stretcher . . . . . 76
- Subgingival curette . . . . . 152
- Suction
- Aspiration . . . . . 352
  - Catheter . . . . . 352
  - Hose . . . . . 352
  - Handle . . . . . 352
  - Unit . . . . . 352
- Sundry jars . . . . . 361
- Supra Condylar osteo plates . . . . . 222
- Surgical
- Cap . . . . . 342
  - Drapes . . . . . 325–328
  - Face mask . . . . . 342
  - Gown . . . . . 343
  - Marker . . . . . 88
  - Mesh . . . . . 269
  - Pack, orthopedic . . . . . 190
  - Positioner . . . . . 265
  - Shoe cover . . . . . 340
  - Towels . . . . . 325
  - Wraps . . . . . 325
- Surgicutt bleeding time, device . . . . . 114
- Suture
- Anchor . . . . . 246
  - Cassette racks . . . . . 3
  - Needles . . . . . 9–10
  - Suture . . . . . 3–8
- Swab, culture . . . . . 24
- Swine OB snares . . . . . 23
- Syringe
- Cap . . . . . 17
  - Pump . . . . . 103
  - Syringes . . . . . 12–15

## T

- T-extension set . . . . . 94
- T-plates . . . . . 221
- Tally counter . . . . . 286
- Tait Docker . . . . . 272
- Tap Handle . . . . . 187
- Tape, adhesive . . . . . 255
- Tarso-Flex kits . . . . . 370
- Tartar scrapers . . . . . 156–157
- Tattoo
- Forceps . . . . . 341
  - Ink . . . . . 341
  - Kit . . . . . 341
- Teat
- Bandage . . . . . 30
  - Cannula . . . . . 30
- Dilators . . . . . 30
- Instruments . . . . . 29–30
- Tubes . . . . . 30–31
- Technovit® . . . . . 54, 208
- Tenotomes . . . . . 36
- Tenotomy scissors . . . . . 79
- Tensioning clamp . . . . . 233
- Test tube
- Balance rack . . . . . 285
  - Cleaner, brushes . . . . . 308
  - Racks . . . . . 282
  - Rocker . . . . . 288
- Therapeutic laser . . . . . 387
- Therapeutic Ultrasound . . . . . 343–344
- Thera-Paw . . . . . 367
- Therapy system, cold . . . . . 357
- Thermal cautery unit . . . . . 331
- Thermal IV . . . . . 107
- Thermal pad . . . . . 379, 381
- Thermo block blanket . . . . . 379
- Thermometer
- Digital . . . . . 75
  - Jar . . . . . 322
  - Mercury . . . . . 75
- Thermoplastic splint . . . . . 182–183
- Thermo pet mat . . . . . 374
- Thermo kitty bed . . . . . 374
- Thoracath chest tube . . . . . 338
- Thoracic
- Drains . . . . . 339–340
  - Positioner . . . . . 268
- Thunderbolt needles . . . . . 16
- Thyroid collar . . . . . 347
- Tibial Tuberosity Advancement . . . . . 239
- Tibial wedge osteotomy plates . . . . . 239
- Tibial wedge osteotomy gauge set . . . . . 237
- Tibial wedge overlay . . . . . 263
- Tie downs, surgical . . . . . 70
- Tissue
- Protection sleeves . . . . . 187
  - Protector, KE . . . . . 202
- Touchless faucet adapter . . . . . 265
- Toenail scissors . . . . . 279
- Toggle
- Bone . . . . . 191
  - Button . . . . . 33
  - Suture . . . . . 33
- Tomahawk cassette holder . . . . . 39
- Tomcat
- Catheter . . . . . 122, 124
  - Positioner . . . . . 265
- Tongue
- Depressor . . . . . 59, 254
  - Forceps . . . . . 84
- Tonometer, Schiotz . . . . . 177
- TonoVet . . . . . 175
- Tooth extractor, Reynolds . . . . . 48
- Tourniquet
- Elastic nylon . . . . . 70

Esmark . . . . . 90  
 Nye® . . . . . 70  
 Quick-release . . . . . 70  
 Towel clamps . . . . . 81  
 TPLO  
 Plates . . . . . 237–238  
 Rotation gauge . . . . . 236  
 Wire guide & Reduction Forceps . . . . . 238  
 Tracheal wash kit . . . . . 37  
 Tracheotomy tubes . . . . . 154  
 Transfer  
 Board . . . . . 76  
 Needles . . . . . 17  
 Pipette . . . . . 301  
 Transfusion bags . . . . . 111–112  
 Transport swabs . . . . . 26, 303  
 Trap transfer restrainer . . . . . 60  
 Trays, sterile . . . . . 327–328  
 Trephines . . . . . 37, 115  
 Trephine, equine sinus . . . . . 37  
 Trocars . . . . . 32–33  
 Trochlear rasp . . . . . 197  
 TTA cages . . . . . 239  
 TTA spinlock Reduction Forceps . . . . . 243  
 TTO kit . . . . . 236  
 Tube  
 Rack, blood . . . . . 280, 304  
 Esophagostomy . . . . . 304  
 Tubular Dressing . . . . . 253  
 Tubular Gauze . . . . . 256  
 Twitch . . . . . 58

## U

Udder infusion cannula . . . . . 30  
 Ultrascope . . . . . 62  
 Ultrasonic  
 Cleaner . . . . . 92, 324  
 Scaler . . . . . 166–170  
 Ultrasound gel . . . . . 274  
 Ultraviolet Light . . . . . 274  
 Umbilical  
 Clamps . . . . . 266  
 Tape . . . . . 22

Universal “F” circuit . . . . . 133  
 Urethrostomy tube, feline . . . . . 122  
 Urinary catheters . . . . . 119  
 Urine  
 Collection bag . . . . . 123  
 Collection kit . . . . . 125  
 Reagent strips . . . . . 296  
 Sediment stain . . . . . 273  
 Urns . . . . . 396–399  
 Unna boot . . . . . 252  
 Uterine  
 Biopsy forceps . . . . . 118  
 Catheters . . . . . 119  
 Culture swabs . . . . . 24  
 Cytology brush . . . . . 24  
 Flushing catheter . . . . . 119  
 Lavage kit . . . . . 26, 120  
 Infusion tubes . . . . . 26  
 Suture Needle . . . . . 32

## V

Vagina, equine artificial . . . . . 25  
 Vaginal  
 Prolapse tape . . . . . 22  
 Speculum, disposable . . . . . 26  
 Speculums . . . . . 58  
 Vaginoscopes . . . . . 61  
 Valve restrictor, pop-off . . . . . 147  
 Vapor wand . . . . . 149  
 Vaporizers . . . . . 147  
 Ventilator circuit . . . . . 153  
 Vessel Dilators . . . . . 106  
 VetCam Video Scope . . . . . 248–249  
 Vet Lite . . . . . 251  
 Vet Pro Infusion Pump . . . . . 102  
 Vial Cup . . . . . 355  
 Vulva suture pins . . . . . 22

## W

Walkabout™ harness . . . . . 371  
 Walkease Hoof Treatment . . . . . 57  
 Walpole solution . . . . . 122

Warm air blankets . . . . . 377  
 Warm air system . . . . . 377  
 Warm Blood . . . . . 380  
 Warm Blood Heater . . . . . 377  
 Warming pump . . . . . 376–377  
 Wash bottles . . . . . 300  
 Washer, spike . . . . . 243  
 Waste disposal . . . . . 378  
 Water bowls, disposable pulp . . . . . 382  
 Water circulating pump . . . . . 376  
 Wavicide solution . . . . . 336  
 Weaner, calf . . . . . 259  
 Web Master Harness . . . . . 365  
 Wedge, dental . . . . . 161  
 Weitlaner retractor . . . . . 83  
 Wing-tip dental elevator . . . . . 160  
 Wipes, push-up . . . . . 302  
 Wire  
 Passer . . . . . 205  
 Passer, Sismey . . . . . 205  
 Twister . . . . . 205  
 Wolftooth  
 Elevators . . . . . 47  
 Forceps . . . . . 48–50  
 Wood light . . . . . 274  
 Wound care, Manuka Honey . . . . . 257–258  
 Wound drainage kit . . . . . 339–340  
 Wound pads . . . . . 257  
 Wye Connector/Adapter . . . . . 135

## X

X-Ray  
 Apron . . . . . 346  
 Eyewear . . . . . 347  
 Viewing box . . . . . 349  
 Cassette holders . . . . . 39–41  
 Film developing hangers . . . . . 349  
 Gloves . . . . . 348  
 Hangers . . . . . 348  
 Measuring caliper . . . . . 349  
 Mitts . . . . . 348  
 Positioning sandbags . . . . . 346



## ITEM/PAGE INDEX

J0001, J0001E.....	265	J0026G.....	22	J0038G.....	46	J0046A-S.....	63
J0003, J0003C.....	265	J0027G.....	36	J0038K.....	45	J0046R.....	63
J0004.....	29	J0027R.....	108	J0038KB.....	45	J0047.....	274
J0005.....	29	J0029.....	27	J0038KP.....	45	J0047A-S.....	64
J0007.....	29	J0029A.....	27	J0038KPB.....	45	J0047AC-SC.....	65
J0008.....	29	J0029C.....	27	J0038M.....	45	J0047RC.....	64
J0009.....	29	J0030CSR.....	27	J0038MPS.....	45	J0049B.....	247
J0009C.....	29	J0030JR.....	27	J0038MPSP.....	45	J0049C.....	205
J0009LB, J0009-LS.....	29	J0030-O.....	27	J0038S.....	45	J0049F, G, FG.....	247
J0010.....	30	J0030PR.....	27	J0038ZM.....	45	J0049HD.....	247
J0011B.....	30	J0030R.....	27	J0040C.....	32	J0049LT, 49LTA.....	341
J0012, J0012D.....	30	J0030SR.....	27	J0040EK.....	37	J0049MA-ME.....	247
J0012X.....	30	J0031A, B, C, E.....	13	J0040F.....	32	J0049MS.....	247
J0013.....	30	J0032E.....	52	J0040OM.....	32	J0049P.....	247
J0013L.....	31	J0032F.....	52	J0040P.....	32	J0049S.....	247
J0014L.....	31	J0032H.....	52	J0040PC.....	32	J0049W.....	247
J0014TB.....	30	J0032HL, HR.....	52	J0041A, B, C.....	161	J0049X.....	247
J0015.....	18	J0032HG.....	53	J0041CC.....	164	J0050A, B, C.....	108
J0015C, J0015CE.....	18	J0032HGS.....	53	J0041CR.....	164	J0051A, B, C.....	59
J0016.....	18	J0032HSE.....	52	J0041E, 41F.....	157	J0051G.....	59
J0017.....	18	J0032HWL, HWR.....	52	J0041G, F.....	157	J0051K, M, N.....	309
J0018, J0018C.....	18	J0032P.....	52	J0041J, 41JA.....	157	J0051Q, 51R.....	161
J0018H.....	18	J0033H.....	52	J0041K.....	157	J0051RDL.....	163
J0018I.....	18	J0034.....	53	J0041MC.....	163	J0051RDLX.....	163
J0018T.....	18	J0034AD.....	52	J0041ME.....	163	J0051RDS.....	163
J0018US.....	18	J0034C.....	53	J0041MI.....	157	J0051RG, 51RGS.....	163
J0019.....	19	J0034CN.....	53	J0041MR.....	164	J0051RK.....	165
J0019C.....	19	J0034CVL.....	52	J0041R, 41RF.....	164	J0051RR.....	163
J0019H.....	19	J0034CVR.....	52	J0041RK.....	164	J0051RS.....	163
J0019R.....	19	J0034L.....	53	J0041SS, ST.....	164	J0051SB.....	59
J0019V.....	19	J0034O.....	53	J0041T.....	157, 334	J0051S.....	321
J0020.....	19	J0034S.....	53	J0042.....	46	J0051X, Y, Z.....	321
J0020D.....	19	J0035.....	56	J0042A, B.....	156	J0052K.....	58
J0020H.....	19	J0035B.....	55	J0042D, E, F, G.....	156	J0052P.....	58
J0021.....	19	J0035EC.....	55	J0042H, HS.....	266	J0053H, HA, HB.....	12
J0021H.....	19	J0035F.....	55	J0042J, 42M.....	156	J0053F91.....	12
J0021L.....	20	J0035LP.....	55	J0042K.....	48	J0053V 94.....	13
J0021S.....	20	J0035P.....	55	J0042Q.....	157	J0054KC, 54KG.....	35
J0022.....	20	J0035XL.....	55	J0042R.....	161	J0054S.....	86
J0022A.....	20	J0036B.....	34	J0042S.....	156	J0055A, 55B.....	86
J0022C.....	23	J0036E.....	34	J0042T.....	161	J0055D.....	86
J0022H.....	20	J0036FS.....	34	J0042X.....	161	J0055FA, 55FB.....	86
J0022T.....	23	J0036G.....	34	J0042W, Y.....	159	J0055GA, 55GB.....	86
J0023S.....	20	J0036HD.....	34	J0043.....	49	J0055PA, 55PB.....	86
J0024GL, GS.....	20	J0036P.....	34	J0043AB.....	47	J0056, 56B.....	266
J0024T.....	20	J0036S.....	34	J0043B.....	49	J0056G.....	266
J0024V.....	22	J0036W, J0036WS.....	34	J0043BM.....	49	J0056HA, HB.....	266
J0024VI.....	22	J0037C.....	35	J0043H.....	48	J0057, 57C, 57F.....	42
J0024VS.....	22	J0037E.....	35	J0043M.....	161	J0057S, 57SF.....	42
J0024W.....	20	J0037EMA to EME.....	35	J0043RL, 43RU.....	48	J0057X.....	44
J0024WH.....	20	J0037H.....	34	J0043S.....	161	J0057XF.....	44
J0024WM.....	20	J0037K.....	35	J0043W.....	47	J0057Y.....	44
J0024WL.....	20	J0037N.....	35	J0043X.....	48	J0058CT.....	42
J0024WS.....	20	J0037S.....	35	J0043Y.....	47	J0058F, 58FT.....	42
J0024XL, XS.....	20	J0037SA.....	35	J0044.....	58	J0058HC.....	42
J0025.....	22	J0037SAS.....	35	J0044A.....	58	J0058L, S.....	42
J0025U.....	22	J0037SS.....	35	J0044B.....	58	J0058P.....	43
J0026.....	22	J0038.....	45	J0045.....	59, 174	J0059, 59D.....	265
J0026E.....	22	J0038D.....	58	J0045A.....	59, 245	J0061B.....	54
J0026EN.....	22	J0038F.....	58	J0046BCA-BCS.....	63	J0061BH.....	54

J0061BX	54	J0081B, BW	81	J0106X	317	J0125AV	25
J0061LA, LB	54	J0081S, WS	81	J0107, 107H, M	197	J0126	15
J0061PA, PB	54	J0082	81	J0108	396	J0128M	15
J0061S	54	J0083C, CW	78	J0109	23	J0130	70
J0061T6	54	J0083S, SW	78	J0109F	23	J0130R	70
J0061T12	54	J0084	279	J0109JB	23	J0130X	70
J0062S, 62ST	36	J0084C	279	J0110A, B	32	J0131M	53
J0063	108	J0084G	279	J0110DU	32	J0132	315
J0063D1	99	J0084H, HX	279	J0110HC	10	J0132L	317
J0064S	108	J0084HR, 84HSR	279	J0110PM	10	J0133	75
J0064B	108	J0084HS	279	J0110SL, SM	32	J0134A	75
J0064T	108	J0085	81	J0110T	10	J0134AC	75
J0064SL	108	J0086-A,B,C	88	J0111AN	14	J0134F	75
J0064BL	108	J0087	35	J0111ANO	14	J0135C, S	78
J0065	114	J0087L	35	J0111AWN	14	J0135CW, SW	78
J0066, 66B	58	J0088A	36	J0111BN	14	J0136	315
J0067	358	J0088BC, BS, SC	36	J0111BNO	14	J0137M	262
J0068	174	J0089	36	J0111BWN	14	J0138	262
J0068B	174	J0090C, H	123	J0111CN	14	J0138C, 138CP	262
J0068D	174	J0090M,S, SM	119	J0111CNO	14	J0138G, GB	262
J0068G, GW	174	J0091	4	J0111CWN	14	J0138N	262
J0070C, CW	77	J0091 series	4	J0111DN	14	J0139	263
J0070S, SW	77	J0091C	4	J0111DNO	14	J0140A, B, C	60
J0071C, CW	77	J0091 S	4	J0111DWN	14	J0141A	60
J0071S, SW	77	J0091PC	4	J0111FN	14	J0142	60
J0072C, CW	77	J0091R5	3	J0111FNO	14	J0142T	60
J0072DV	78	J0092	82	J0111JW	14	J0143A-D	154
J0072RO, ROW	78	J0092BA	82	J0111Q	14	J0144A, B	154
J0072RS, RSW	78	J0092BX, BXW	82	J0111S	14	J0147	67
J0072S, SW	77	J0092DV	82	J0112A, B	84	J0147P	67
J0073C, CW	77	J0092P	82	J0112M	84	J0148A-R	127
J0073S, SW	77	J0092Q, QW	82	J0113 series	367	J0148S, T, U, V	127
J0074A, B	78	J0092R	82	J0114BHM	61	J0149A-M	127
J0074HB	78	J0092TA, TAW	82	J0114H	61	J0149STA-STC	130
J0074WA, WB	78	J0092TB, TBW	82	J0114I	61	J0149T-Y	127
J0074X	78	J0092TC, TCW	82	J0114J	61	J0149VC-YC	127
J0075A-F	80	J0092TD	82	J0114KM	61	J0150	178
J0075AW-FW	80	J0092W	82	J0114L	61	J0150A, B	176
J0075CMW	80	J0092X	82	J0114NL	61	J0150C	178
J0075IWC, IWS	80, 174	J0093A, B, C, D	79	J0114NS	61	J0151AT	129
J0075N	277	J0093E	51	J0114OL	61	J0151Q, S	130
J0075SMW	80	J0093BW	79	J0114OM	61	J0151X,Y,Z	129
J0075TB, TS	79	J0094, 94H	230	J0114OS	61	J0151XA-YA	129
J0075U, US	78	J0095	266	J0114S	59	J0152A-N	127
J0076	79	J0099	21	J0114T	59	J0153	122
J0076SW	79	J0099C	21	J0115	267	J0153BA, BB	121
J0076W	79	J0099E	21	J0116A	118	J0153C, D, E	122
J0077AC, AS	80	J0099FM	23	J0116C	115	J0153JA, 153JB	121
J0077BC, BS	80	J0099K	23	J0116JW	118	J0153JAS, JBS	121
J0077CWA	80	J0099S	23	J0116K, 116M	115	J0153W	122
J0077CWB	80	J0100	27	J0116Q	118	J0153X-Y	122
J0077SWA	80	J0100B, BL	28	J0116RA, RB	115	J0154XS, S, M, L	123
J0077SWB	80	J0100D, 100DS	28	J0116S	115	J0155B-F	266
J0078A, B	81	J0100S	28	J0116T	115	J0156A, CA	176
J0078WTA	81	J0101	267	J0116U	116	J0156D, DS	176
J0078WTB	81	J0102	24	J0116VS	116	J0156F, FC	176
J0078X	81	J0102D1, D9	24	J0117	116	J0157 series	130
J0079A, B	81	J0102D3	24	J0118	116	J0158	204
J0079WTA, B, D	81	J0103	61	J0118A-D	116	J0159, 159L, M	189
J0080	81	J0105R	9	J0119A, B, C	181	J0159RF	190
J0080A, B	81	J0106A, B	309	J0119Q, R, S	181	J0160 series	135
J0080AW	81	J0106F, S, M, L	317	J0119X, Y, Z	181	J0161A, B, C, E	37
J0080WT	81	J0106FE-SE	317	J0122A, B, C	31	J0163A, B	117
J0080WTH	81	J0106FG-SG	317	J0123	25	J0163D4, D6, D8	117
J0081A, AW	81	J0106FX-SX	317	J0125	25	J0164, 164A	125

J0165.....	125	J0212S.....	189	J0238M.....	229	J0272.....	24
J0166M.....	329	J0212TC, TS.....	189	J0238S.....	229	J0273.....	24
J0166RM.....	329	J0212X.....	189	J0238-SD.....	229	J0273C.....	24
J0167Q.....	130	J0213.....	189	J0240, 240E.....	83	J0274.....	24
J0167QD1.....	130	J0213C.....	188	J0240M, ME.....	83	J0275.....	41
J0168A, B.....	300	J0213Q.....	188	J0240MA.....	83	J0276 series.....	341
J0169 series.....	71	J0213VA, VB.....	189	J0240Q.....	243	J0277A, B, C.....	30
J0170-170X.....	73	J0214.....	229	J0240WA, WB, WM.....	243	J0277BS.....	30, 37
J0171A.....	70	J0214K.....	198	J0240WWS.....	243	J0278A, B, C.....	31
J0171Q.....	70	J0214L.....	229	J0240XA.....	244	J0279A, B, C, S.....	268
J0172.....	73	J0214LD1, LD2.....	229	J0240XA.....	244	J0279T.....	268
J0173.....	17	J0214S.....	188	J0241, 241E.....	83	J0281.....	37
J0173S.....	17	J0215, 215A.....	198	J0241MA.....	83	J0282.....	119
J0173T.....	17	J0215L.....	206	J0242, 242L.....	83	J0282D1, D2, D3.....	98
J0174.....	16	J0215M.....	195	J0242Q.....	83	J0282D4.....	98
J0176.....	272	J0216, 216A-D.....	223	J0242QM.....	83	J0282L.....	119
J0177A, B, C.....	9	J0217.....	205	J0243.....	83	J0282Y, 282YL.....	119
J0178.....	265	J0218.....	206	J0243B.....	83	J0283.....	37
J0178AB.....	265	J0218L.....	206	J0243G.....	83	J0284.....	26
J0178B.....	265	J0218LD.....	206	J0243XA, XB, XC.....	83	J0286.....	26
J0178H.....	265	J0219, 219X.....	190	J0244A.....	83	J0286P.....	26
J0179.....	261	J0220.....	204	J0247, 247A.....	133	J0286S.....	26
J0180.....	16	J0220BA, BB.....	204	J0248A-E.....	133	J0287.....	26
J0182, 182M.....	266	J0220P.....	204	J0248EA.....	133	J0289.....	181
J0185, 185P, S.....	261	J0220Q.....	204	J0248F, FA.....	133	J0289P.....	181
J0185M, 185MS.....	261	J0220X.....	204	J0248FAL.....	133	J0290A, 290B.....	256
J0186.....	256	J0221.....	205	J0248FL.....	133	J0290AP.....	256
J0187F.....	75	J0222A, B, H.....	196	J0248G.....	133	J0291B-E.....	253
J0187Q.....	75	J0222N, P, Q.....	196	J0248K, KA.....	133	J0291AC-EC.....	186, 249
J0187QD.....	75	J0223.....	196	J0248Q, T.....	133	J0292A-E.....	253
J0187R.....	75	J0223A, B.....	196	J0249A, B, C.....	135	J0293A-D.....	255
J0188.....	75	J0223S.....	196	J0249B2.....	135	J0294, 294G.....	278
J0191.....	33	J0224, 224F.....	194	J0249E.....	135	J0296.....	39
J0191B.....	33	J0224C.....	194	J0249H, J.....	135	J0297AN-DN.....	134
J0191TM.....	33	J0225C, E, S, L.....	194	J0249Q.....	135	J0298C.....	134
J0192A, B.....	251	J0225X.....	50	J0249R, R2.....	135	J0298DA-DS.....	134
J0193A-D.....	251	J0226A, B, C.....	194	J0249S, T, V.....	135	J0298DD, DE.....	134
J0194C.....	321	J0226Q.....	196	J0249X.....	135	J0298F.....	134
J0194FA, FB, FC.....	321	J0226R.....	194	J0249Y.....	135	J0298HA-HC.....	134
J0194S.....	321	J0226S.....	194	J0250.....	198	J0298MV.....	143
J0195, 195A.....	251	J0227A, B.....	195	J0250A-I.....	198	J0300D, 300DS.....	27
J0196.....	254	J0228A, B.....	195	J0250K, KD.....	198	J0301.....	136
J0197.....	253	J0228M.....	197	J0250L, LD.....	198	J0302.....	137
J0198.....	119	J0228X.....	197	J0250M, N, P.....	198	J0302D1, D2, D2W.....	137
J0199A, B, C.....	108	J01228Xd1.....	197	J0250Q.....	197	J0302T.....	136
J0201.....	58	J0229.....	115	J0250X, Y.....	198	J0302W.....	137
J0203, 203L.....	60	J0230A-S.....	71	J0251A-I.....	198	J0304, 304K, R.....	136
J0205A, B, C.....	132	J0231, 231E.....	176	J0256A-J.....	325	J0306.....	278
J0205G, R, BK, C, Y.....	61	J0231GC, GS.....	176	J0257A, B, C.....	325	J0307, 307D1.....	279
J0205U, 205UC.....	62	J0232, 232E.....	176	J0257D.....	325	J0308.....	396
J0205UT, UTE.....	62	J0232C.....	176	J0258.....	326	J0308A, B, C.....	396
J0206.....	17	J0232H.....	176	J0258A-E.....	326	J0309H.....	265
J0209.....	197	J0233, 233B.....	234	J0258Q, S, W.....	326	J0310L & S.....	396
J0209F.....	197	J0235A, B.....	245	J0259A, B.....	325	J0310LQ, SQ.....	396
J0209R.....	238	J0235M.....	245	J0259Q, R, S.....	326	J0310SQT, LQT.....	396
J0210.....	197	J0235S.....	245	J0259X, 259XS.....	326	J0312M, 312B.....	274
J0211.....	198	J0235X, Y, Z.....	245	J0260A-F.....	206	J0312Q, QF, QB.....	274
J0211Q.....	198	J0236, 236S, L.....	245	J0260AL, BL, CL.....	206	J0312S, SF, SB.....	274
J0212.....	186	J0236C.....	245	J0260X.....	206	J0313.....	333
J0212EF, EFA, EFB.....	275	J0236H.....	245	J0261A-C.....	184	J0313A, B.....	333
J0212GS.....	190	J0236M.....	245	J0261SB.....	184	J0313W-Z.....	333
J0212KL.....	189	J0236SE.....	233	J0265.....	132	J0314A, B.....	174
J0212L, 212LS.....	189	J0236T, TC.....	233	J0266A, E.....	100	J0315.....	272
J0212M.....	189	J0236XL, XS.....	245	J0267A-S.....	107	J0316 series.....	397-399
J0212P.....	189	J0238D1.....	229	J0271.....	26	J0317A-D.....	397



J0317X, Y	397	J0367M	336	J0381P	320	J0418A-D	215
J0319G, H, K	386	J0367SM	336	J0381S	320	J0419A-R	218
J0320P	100	J0369, 369L	335	J0382A, B	324	J0419DC-PC	218
J0320PL	100	J0370K	29	J0382AB, BB	324	J0420A-I	216
J0321A-E	318	J0370L	29	J0382G	91	J0421A-S	218
J0322 series	280	J0370P	29	J0384, 384S	358	J0422A-I	219
J0323	280	J0370X	29	J0384X	358	J0422BA-BI	219
J0324, 324A	280	J0371A-H	202	J0385A, B, C, D	312	J0423A-S	219
J0325	280	J0371AQ, BQ, CQ	199	J0385E-P	315	J0424A-N	219
J0325FM	281	J0371BP-HP	202	J0386 series	314	J0425A-N	219
J0326	280	J0371DFM	201	J0389, 389L	311	J0426A-L	220
J0326A	281	J0371DFS	201	J0390, 390L	309	J0427	190
J0326AS	281	J0371DL	200	J0391	279	J0427A-J	220
J0326B	281	J0371DLC	201	J0391Q	320	J0427DB-PB	220
J0326S	281	J0371DM	200	J0392A, B	322	J0428A-G	221
J0326U	281	J0371DMC	201	J0393A, B	322	J0428Q-U	222
J0330EC	278	J0371DMS	201	J0394	322	J0428XL	226
J0334A	289	J0371DS	200	J0395A, B	322	J0428X	226
J0334AC, ACS	290	J0371DSS	201	J0396	322	J0428Q-U	222
J0334AD2	290	J0371K	199	J0396A	322	J0428Z	226
J0334DC	291	J0371KAL	201	J0397	322	J0429, 429D	214
J0334MEP	290	J0371KAM	201	J0398	322	J0429S	214
J0334MI5	290	J0371KAS	201	J0398A	322	J0430, 430D	210
J0334MI5	290	J0371KBL, KBM, S	200	J0398B	322	J0430S	210
TJ0334MPD4	290	J0371KBL, KM, KS	200	J0398C	322	J0430PC	228
J0334AT	289	J0371KL	200	J0398S	322	J0430PCA	228
J0334X, 334XT	292	J0371L	200	J0399A	322	J0430PCB	228
J0334Q	289	J0371LL	200	J0399B	322	J0431LP	193
J0335	298	J0371LM	200	J0400	92	J0431XL	193
J0335F	298	J0371LS	200	J0400A	93	J0431XPS	193
J0336	298	J0371M	200	J0400E	109	J0432	77
J0336P	298	J0371PA, PB, PC	200	J0400L	109	J0433, 433A	227
J0337	298	J0371R series	200	J0400LE	109	J0433BL, BR	227
J0337A	298	J0371RX series	200	J0400P, Q	108	J0433CR, CL	227
J0337L	298	J0371S	200	J0400T	109	J0433D-N	228
J0339 series	256	J0371SCL	199	J0400X	108	J0433P-W	227
J0341, J0341A, B	340	J0371SCM	199	J0400Y	92	J0433X	227
J0342A-D	369	J0371SCS	199	J0401A-E	211	J0433Y	227
J0343	203	J0371TLA, TLB	201	J0441F	49	J0433YS	227
J0343A-D	203	J0371TM series	201	J0402A-H	211	J0435	87
J0345M	70	J0371TP	202	J0403A-K	211	J0436A, G, W	242
J0347A-G	309	J0371TSA, TSB	201	J0404A-O	212	J0436G	241
J0348A, B, C, D	309	J0371XA, XB	199	J0405A-K	212	J0436E, F	236
J0348Q, R	312	J0372A-I	209	J0406A-O	213	J0438A, B, C	237
J0349	278	J0372AX-GX	209	J0407A-N	213	J0438AL, BL	218
J0350A	316	J0372CNA	209	J0408A-H	213	J0438ALA-ALD	238
J0350A-K	314	J0372CNB	209	J0409A-F	215	J0438AC, BC, GP	237
J0351	295	J0372CNC	209	J0409LH	188	J0438DG	224
J0351B	295	J0372CZ	209	J0410	187	J0438J-Z	226
J0352	282	J0372DK	209	J0410A	187	J0438L	224
J0352X	282	J0372J, K, L, N	202	J0411B-D	187	J0438LA-LZ	224
J0352D	282	J0372M, 372P	228	J0412A, 412AS	187	J0438LD-LR	238
J0353	304	J0372X, 372XC	210	J0412B, 412BS	187	J0438LHP5-14	223
J0353A-E	304	J0372W, 372Y	188	J0412C, 412CS	187	J0438MA-MD	224
J0353AS	304	J0373A-F	222	J0412CH	239	J0438P	224
J0353CS	304	J0374A	212	J0412X	187	J0438TPC	237
J0355	134	J0374A-H	221	J0413	188	J0439 series	237
J0355A-S	134	J0374B	211	J0414, 414E	184	J0440, J0440A, B	51
J0359	22	J0374M-S	221	J0414A, AA, B, BB	187	J0441, J0441A, B	51
J0360	265	J0375A, B, C	228	J0414F, 414G	187	J0442	193
J0361	266	J0375F, G, H	192	J0414H, HL, HX	191	J0442Q	193
J0364	90	J0375WC, WD, WE	245	J0415A-D	188	J0444A-S	235
J0364D	90	J0376	318	J0416A-J	215	J0444B	235
J0364S	90	J0378	318	J0416BC-JC	215	J0444DB	235
J0366	335	J0379	318	J0417A-E	215	O444F	236
		J0381A to D	320				

J0444FA	236	J0470	331	J0506	177	J0538	141
J0444G	236	J0470B	331	J0507A, B	277	J0538A, B, C	138
J0444K	191, 236	J0470D2, D3	331	J0508	277	J0538E, M	138
J0444M, MA, MB	233	J0470DT1-9	331	J0513	277	J0538NS	138
J0444N, P	191	J0473	38	J0515	277	J0538X	139
J0444R, T, U, V	236	J0473A, B, C	38	J0518, 518S	171	J0539DM, DMC	139
J0444Q	246	J0475CV	292	J0519, 519S	171	J0540	138
J0444X	246	J0477DS	178	J0520	111	J0540N	138
J0444Y	246	J0477L, R	178	J0520AB	112	J0541	142
J0444Z	246	J0478L, R	178	J0520AX	112	J0542	301
J0445A, B, C	313	J0478XL, XR	178	J0520A-F	111	J0543	301
J0446B-G	313	J0479D	178	J0520Q	111	J0543M	301
J0446M-R	314	J0479DS	178	J0520TA-TD	111	J0543P	301
J0447A-S	313	J0478DS, XLDS	178	J0520X	111	J0544	301
J0447Q, R	313	J0479L, R	178	J0520Y	112	J0544M	301
J0448A-C	235	J0480A, B, C	87	J0521	113	J0544P, PB	301
J0449A-F	131	J0481A-D	87	J0522	113	J0545	301
J0449AM-EM	131	J0482A, B, C	76	J0522A	113	J0546, 546A	302
J0449M, 449P	131	J0484M	331	J0522H, T	114	J0546C	301
J0449R, 449RL	131	J0484A 1-A8	332	J0522P	114	J0546E	302
J0449S	131	J0484A9-A14	332	J0522S, J	114	J0548	302
J0452D1-13	169	J0484AD1-5	332	J0523A, B	339	J0548A	302
J0452D1P	166	J0484B1-B7	332	J0524A, B	339	J0549A, 549C	297
J0452D4	166	J0484BC	330	J0524C-G	339	J0552A, B, C	308
J0452D7	164	J0486A	90	J0524M-Q	339	J0553, 553B	146
J0452D10	169	J0486AN	90	J0526 series	117	J0553C	146
J0452D11	171	J0486B	90	J0527 series	117	J0554, 554B	274
J0452D12	169	J0486BN	90	J0528A, B, C	115	J0555	303
J0452D14	171	J0487B	90	J0529 series	117	J0555NS	303
J0452D15	169	J0487E, D, F	90	J0530VR	140	J0556A, B	303
J0452D17	169	J0488, 488L	352	J0530YR	140	J0557	303
J0452D19	169	J0489, 489A	352	J0533	140	J0558N	149
J0452D13M, D13RF	171	J0489F	352	J0533A, E, EF	142	J0558NA	149
J0452k1-10	170	J0489M, ME	352	J0533AV, PS	141	J0558NACE	144
J0453	165	J0489P	352	J0533EM	141	J0559	145
J0454A-D	103	J0490A, B	251	J0533G, H, J	138	J0559A, B	145
J0455	74	J0490AS, BS	251	J0533F, M, X, Z	139	J0559ACEM	144
J0456A-F	371	J0492M	39	J0533MH	140	J0559D3	148
J0456S	371	J0492X	41	J0533SV	141	J0559T, 559TA	145
J0457A, B	101	J0493M, X, W	40	J0533TAV	141	J0559W	145
J0458A-D	101	J0494M	39	J0533X, Z	139	J0559WA, WB	145
J0459	352	J0495RB	41	J0533ZV	141	J0559WS, WSB	145
J0459D1	352	J0496	43	J0534A, B, C, D	142	J0560AS	141
J0460	75	J0496A, B, C, D	43	J0534BG	142	J0560E	145
J0461, 461A	107	J0496DRP	43	J0534EA, EC	142	J0561S, AS, BS	146
J0461X	378	J0500A-F	64	J0534EFM, EW	142	J0561BC, AC, SC	146
J0462	109	J0500S	64	J0535A, FA	138	J0562A, S	147
J0462S	109	J0501BT	282	J0535B, C	139	J0562D	147
J0463	93	J0501C	284	J0535FB, FC	139	J0562X, Y	148
J0463A	93, 285	J0501H	287	J0536A, FA	138	J0563	330
J0463C	93	J0501IR	285	J0536B, BA	139	J0563D1A, J0563D4A	330
J0463D	93	J0501P	286	J0536FB, FC	139	J0563Q-V	330
J0463L	93	J0501RC	301	J0536T	138	J0570A-C	252
J0463P, Q	98	J0501SQ	284	J0536X, XA	138	J0571A-D	252
J0463X	98	J0501SQI, SQIC, SQR	284	J0536Y, YA	138	J0572A-D	252
J0464M	17	J0501SX	285	J0537, J0537D	139	J0573	252
J0466	93	J0501UM	283	J0537A, C, E	139	J0574A-C	253
J0467	94	J0501W	283	J0537AVD	140	J0578	99
J0467B	95	J0502M	283	J0537NC	140	J0579C	90
J0467C	95	J0502A, B	277	J0537NSC	140	J0579H	90
J0467E-G	94	J0503M	284	J0537NSWC	140	J0579S	90
J0467Q, R, S, T	94	J0504Y, X	287	J0537NW	140	J0579T	90
J0467W, Y, Z	94	J0505	288	J0537Q, R, S, T, V	140	J0580-J0586	86
J0468B, M	93	J0505A, B	289	J0537W	140	J0580S-586S	86
J0468MA	93	J0505C	288	J0537VAC	140	J0590A, B	339

J0591	.....98	J0662C	.....85	J0712	.....46	J0803A-E	.....323
J0594	.....98	J0662D	.....85	J0713	.....46	J0804A-D	.....323
J0594A	.....98	J0662DC	.....85	J0714, 714A, B, C	.....233	J0805A-E	.....323
J0595A, B, C, D, E	.....143	J0663	.....85	J0723, 723H	.....388	J0806Y, 806Z	.....349
J0596, 596A	.....98	J0663C	.....85	J0724, 724H	.....388	J0807, 807D	.....323
J0598	.....99	J0664	.....176	J0726G	.....36	J0807M, 807T	.....323
J0599	.....98	J0664T	.....334	J0730	.....342	J0808, 808F	.....323
J0599X	.....99	J0664K	.....176	J0731, 732, 733	.....342	J0809	.....387
J0600, 600MC	.....272	J0665, 665L	.....334	J0734, 734L	.....342	J0809P, PL	.....387
J0603	.....319	J0666	.....334	J0735	.....342	J0809R	.....387
J0604	.....319	J0667	.....334	J0736, J737	.....343	J0810 series	.....355-356
J0605	.....70	J0600C, CA	.....272	J0738, 738L	.....343	J0811E, J, M, Q	.....356
J0606A, B	.....143	J0668, 668P	.....184	J0738XP, XPL	.....343	J0812	.....307
J0607	.....319	J0676 series	.....346	J0739A, B, C	.....343	J0813M	.....287
J0610A-S	.....66	J0676E	.....347	J0739M, N, P	.....343	J0814, 814X	.....281
J0612	.....318	J0676EF	.....347	J0740, 740L	.....321	J0815	.....299
J0613, 613S	.....360	J0676EH	.....347	J0742	.....76	J0816	.....299
J0614G, S	.....361	J0676TA, TB	.....347	J0742A, B	.....76	J0816R, S, T	.....299
J0615A-M	.....126	J0677 series	.....348	J0743A, S	.....371	J0816X	.....298
J0615X	.....129	J0678A, B	.....348	J0744A, C	.....148	J0817	.....300
J0619, 619C	.....361	J0678N	.....347	J0744E	.....144	J0817A-S	.....300
J0619G-N	.....361	J0679N	.....347	J0751, 751A	.....251	J0818, 818A	.....300
J0619R	.....361	J0684	.....349	J0752 series	.....373	J0819, 819A	.....288
J0619X	.....361	J0686	.....151	J0752X	.....244	J0820A, B, D, E	.....255
J0629A-J	.....129	J0686A, B	.....151	J0752Y	.....244	J0820AN-EN	.....255
J0630A	.....296	J0686K	.....151	J0753	.....295	J0821, 821C	.....291
J0630G	.....296	J0686R	.....142	J0753K	.....295	J0821X	.....291
J0630K	.....296	J0687A	.....151	J0755	.....294	J0822A,B,C,D	.....226
J0630X, Y	.....296	J0690A-M	.....154	J0755T	.....294	J0822F	.....236
J0631A, B, C	.....131	J0691A-J	.....154	J0756	.....132	J0822QM5	.....293
J0632, 632A-D	.....183	J0692	.....154	J0758A-D	.....255	J0822RCA	.....293
J0632M-MD	.....183	J0692A, B, D	.....154	J0758SA-SC	.....255	J0822S, X, T	.....241
J0633M-MA	.....183	J0693 series	.....314	J0759, 759A	.....255	J0823	.....357
J0634M-MD	.....183	J0693SA, SB, SC	.....119	J0762 series	.....66	J0824, 824C	.....357
J0639	.....36	J0693SC, SD	.....313	J0766	.....381	J0825	.....353
J0640	.....14	J0694, A, B	.....129	J0767, 767A	.....381	J0825EM	.....354
J0641	.....14	J0695	.....352	J0768, 768A	.....381	J0825M	.....353
J0641S, SN, SL	.....341	J0695A-D	.....352	J0769, 0769A	.....381	J0825QMSF	.....353
J0642	.....341	J0696, 696D	.....360	J0770D, F, DF	.....351	J0825PM, QM	.....353
J0643	.....341	J0697	.....358	J0771, C, S	.....351	J0825SS	.....353
J0643L	.....341	J0698	.....360	J0772	.....351	J0826A, B	.....354
J0644 series	.....100	J0699	.....46	J0773	.....351	J0826Q, R, S	.....354
J0645	.....118	J0701	.....46	J0775	.....351	J0826X	.....353
J0646	.....275	J0702	.....43	J0776	.....351	J0827	.....302
J0647	.....91	J0703	.....50	J0781	.....23	J0829, J0829A, B	.....221
J0648	.....91	J0704	.....48	J0783X	.....376	J0830	.....99
J0649	.....91	J0705	.....46	J0784Q, R	.....376	J0831	.....99
J0650A-S	.....181	J0705F	.....51	J0784W	.....376	J0831A-F	.....99
J0651A-H	.....181	J0709	.....47	J0784X, Y, Z	.....376	J0832 series	.....87
J0651BX-HX	.....181	J0710	.....232	J0787, 0787L	.....357	J0832X	.....87
J0651S, 651X	.....181	J0710A-G	.....232	J0788	.....357	J0833	.....110
J0652A, B, C, S	.....150	J0710CCG	.....232	J0790A, B, C	.....340	J0833H	.....110
J0653	.....150	J0710EB, FB, GB	.....232	J0791	.....74	J0833S	.....110
J0654	.....150	J0710K, M, P	.....232	J0791M	.....74	J0833T	.....110
J0655, 655L	.....150	J0710KD, MD, PD	.....229	J0793, 0793A	.....261	J0835A-R	.....126
J0656, 656A	.....150	J0710KE, ME, PE	.....229	J0794	.....261	J0835W, X, Y, Z	.....126
J0659, J0659A	.....267	J0710N series	.....234	J0795A-E	.....88	J0836	.....246
J0659B	.....267	J0710Q	.....233	J0796A-E	.....88	J0836A-G	.....246
J0659C	.....267	J0710R	.....233	J0796AL-EL	.....88	J0836K	.....246
J0659D	.....267	J0710T	.....234	J0796DLA-ELA	.....88	J0836X	.....246
J0660	.....85	J0710V	.....233	J0799, 799R	.....11	J0836Y	.....246
J0660A	.....85	J0710W, X, Y, Z	.....232	J0800, 800S, X	.....11	J0836Z	.....246
J0661	.....85	J0710SX, SAX	.....233, 234	J0800M	.....11	J0837U	.....245
J0661A	.....85	J0710XA	.....232	J0801 series	.....271	J0838	.....244
J0662	.....85	J0711	.....47	J0802A-J	.....323	J0838A-D	.....244



J0838K.....	244	J0888A, B, C.....	254	J0940W, X, Y.....	186	J1046.....	297
J0839.....	361	J0890.....	86	J0941A, B, C.....	276	J1048 series.....	44
J0840P, Q, R, S.....	383	J0891.....	86	J0941K.....	276	J1049.....	308
J0841D2–D5.....	167	J0891A.....	86	J0941M, N, P.....	276	J1050 series.....	203
J0841LA.....	169	J0892.....	295	J0941X.....	276	J1050AT.....	203
J0841Q.....	167	J0893.....	295	J0942.....	153	J1050BT.....	203
J0841X.....	167	J0894, 894E.....	84	J0943.....	158	J1052 A,B.....	120
J0842Q.....	168	J0895.....	84	J0943C.....	158	J1053.....	333
J0842X.....	168	J0896.....	84	J0943X.....	158	J1054.....	265
J0843.....	153	J0897A–S.....	159	J0944, 944C.....	158	J1055A–F.....	69
J0844.....	38	J0897AS–SS.....	160	J0945.....	342	J1055AM–FM.....	69
J0845.....	113	J0897Q.....	159	J0946.....	342	J1055G.....	69
J0846.....	333	J0898A, B, S.....	158	J0949M.....	153	J1055S.....	69
J0846A–E.....	333	J0899.....	158	J0950, 950B.....	67	J1056.....	159
J0846D1.....	333	J0889S.....	158	J0952.....	287	J1057A, B.....	152
J0849A, B.....	256	J0899A–D.....	158	J0953, 953Q.....	152	J1058A, B, C.....	152
J0849AN–DN.....	256	J0899T.....	159	J0954.....	43	J1059 series.....	247
J0849AS–DS.....	256	J0900.....	105	J0955, J0955A, B.....	379	J1060A–F.....	327
J0849Q.....	256	J0900B.....	105	J0956, J0972.....	16	J1060MN.....	103
J0850.....	250	J0901RF.....	33	J0969.....	169	J1061A, B, C.....	327
J0852A.....	192	J0902S.....	277	J0973N.....	155	J1062A–F.....	327
J0853A, B.....	192	J0902DM, DS.....	277	J0973AH–H.....	155	J1063A, B, C.....	327
J0854 series.....	190	J0903.....	31	J0974 series.....	382	J1064A–D.....	327
J0854X.....	193	J0904.....	31	J0975 series.....	382	J1065A–D.....	327
J0854Y.....	193	J0905.....	31	J0976 series.....	382	J1066.....	205
J0855A, B.....	304	J0910C, S.....	80	J0975C, D.....	382	J1066A.....	205
J0856A, B, C.....	304	J0910SA, SC.....	80	J0978A–S.....	353	J1067 series.....	389
J0857A, B.....	304	J0911S, C, CA.....	80	J0979A–E.....	365	J1068, 1068A.....	195
J0858A, B, C.....	254	J0912, 912G.....	207	J0988.....	312	J1068H.....	195
J0859A, B, C.....	254	J0912Q.....	228	J0989.....	383	J1068MA, MB, MC, MD, ME, MF, MQ, MK.....	195
J0860A, B.....	208	J0913, 913G.....	207	J0989X.....	383	J1069.....	67
J0861A.....	208	J0914.....	45	J0990, 990C.....	149	J1070 series.....	229
J0862A.....	208	J0915, 915A, B.....	60	J0992.....	177	J1072A.....	214
J0863, 863K, T.....	191	J0916A, B.....	379	J1000, 1000D1.....	175	J1072CD.....	214
J0863X.....	191	J0917, 918.....	379	J1001.....	125	J1072GAT–GCT.....	240
J0864 series.....	367	J0920R.....	261	J1003 series.....	65	J1072GATC.....	240
J0865 series.....	365	J0921.....	22	J1004 series.....	368	J1072HAT–HCT.....	242
J0866 series.....	230	J0925A, B, C.....	89	J1005 series.....	369	J1072HCTC.....	239
J0866KMR.....	230	J0926A–D.....	89	J1010.....	329	J1072JAT–JCT.....	239
J0866MR.....	230	J0926E–S.....	89	J1011A–S.....	68	J1072JBTC.....	239
J0867, 867A.....	303	J0927A, B, C, E.....	181	J1012A, B, C.....	68	J1072KAT–KCT.....	242
J0867T.....	303	J0928.....	89	J1021.....	263	J1072KCTC.....	240
J0869.....	294	J0929.....	89	J1022.....	263	J1072LAT–LCT.....	242
J0869K.....	294	J0931.....	165	J1024 series.....	56	J1072LCTC.....	240
J0869S.....	294	J0931A.....	165	J1026, 1026A.....	275	J1072MAT–MCT.....	242
J0869T.....	294	J0932.....	358	J1027, 1027A.....	123	J1072MCTC.....	240
J0870.....	16	J0933A, B.....	359	J1028G.....	287	J1072Q.....	241
J0871, 871B.....	256	J0934.....	359	J1030A, B, C.....	255	J1072RAT–RCT.....	242
J0872.....	74	J0935A, H.....	44	J1032 series.....	17	J1072RCTC.....	240
J0873.....	74	J0936A, H.....	44	J1033 series.....	17	J1072SAT–SCT.....	242
J0874.....	74	J0937A, H.....	44	J1034 series.....	377	J1072SCTC.....	240
J0876, 876A.....	307	J0937S.....	44	J1034Q.....	377	J1072SB, Q, R.....	240
J0876Q, R, S, X.....	307	J0937X, 937Y.....	44	J1034X.....	377	J1072J–P series.....	240
J0877.....	307	J0938.....	50	J1035.....	368	J1072JA–PF series.....	240
J0878.....	282	J0938H.....	48	J1036 series.....	269	J1072K.....	241
J0879.....	282	J0938M.....	50	J1036D5–D6.....	269	J1072TF3–TF8.....	242
J0879A.....	282	J0939.....	50	J1037.....	308	J1072TK, T.....	241
J0880, J0880A.....	256	J0939A, B.....	50	J1038.....	96	J1072W.....	240
J0881, 881G.....	338	J0939K.....	50	J1039A.....	96	J1072X4–12.....	240
J0882A, B, C.....	336	J0939X.....	51	J1039C.....	96	J1072XZ.....	240
J0883.....	336	J0940A, B, C.....	185	J1040, 1040A.....	105	J1073 series.....	242
J0884A–S.....	73	J0940CD.....	185	J1041, 1040A.....	105	J1073AA–Q.....	216, 240
J0885.....	307	J0940F, G, H.....	185	J1042, 1042A.....	105	J1073AT–QT.....	241
J0886A.....	389	J0940K.....	185	J1044A, B.....	105	J1073CNG.....	216
J0887.....	79	J0940S, T, V.....	186	J1045A, B.....	105		

J1073DCP	216	J1133S	224	J1215M	192	J1305 series	104
J1073FP	241	J1134 series	84	J1217A-E	226	J1306 series	401
J1073LNG	187	J1135	294	J1218A	188	J1307 series	401
J1073SIP	216	J1137 series	97	J1218 series	188	J1308 series	401
J1074 series	239	J1138	270	J1219	217	J1309 series	401
J1074A-J	216	J1138A	270	J1219A	217	J1315	337
J1075 series	201	J1138B	270	J1220A-Q	223	J1315A	337
J1076 series	222	J1138M	270	J1220BR, BK	223	J1316 series	95
J1079	254	J1138MA	270	J1221A-N	223	J1316T	94
J1080A, B	359	J1139	266	J1223A, B	226	J1318 series	112
J1081	114, 285	J1140 series	97	J1225 series	84	J1319	96
J1081Q	388	J1141	307	J1225A-S	84	J1320	66
J1081X	113	J1142	97	J1230 series	162	J1321 series	266
J1281Y	113	J1143	236	J1231 series	162	J1322	57
J1082	383	J1145	211	J1232 series	37	J1322B	57
J1083	310	J1146 series	349	J1233 series	187	J1322G	57
J1084, J1084A	250	J1148	308	J1233A-E	187	J1322R	57
J1085	310	J1150A-E	160	J1234 series	393	J1322S	57
J1086A-D	326	J1150A-S	160	J1235 series	72	J1323 series	264
J1087 series	310	J1152 series	384	J1240	372	J1324 series	264
J1088 series	73	J1152A	384	J1243	372	J1325	56
J1089	187	J1153 series	384	J1244	270	J1326	56
J1089A	187	J1160	380	J1245	362	J1326L	56
J1092, 1092A, B, C	49	J1160 series	358	J1246 series	268	J1328	264
J1093, J1093A	49	J1170 series	344-345	J1247A, B	269	J1329	95
J1094 series	308	J1171 series	344-345	J1248, J1248A	269	J1330 series	225
J1095A-S	65	J1172 series	344-345	J1249 series	269	J1332 series	225
J1096	103	J1173LNG	184	J1250	306	J1334 series	225
J1097	102	J1173 series	344-345	J1251 series	257	J1335 series	238
J1098	102	J1174 series	344-345	J1252 series	257	J1336 series	225
J1100 series	249	J1175 series	344-345	J1253 series	257	J1339	250
J1100M	249	J1176 series	344-345	J1256	273	J1339 series	72
J1101ED	305	J1180	166	J1257	269	J1340	157
J1101RD	305	J1180BP	170	J1258 series	258	J1342	394
J1101SD	305	J1180BPL	170	J1259	258	J1343 series	394
J1102	378	J1180D1-12	170	J1260	259	J1344 series	395
J1103	378	J1181	166	J1260A	259	J1345A, J1345B	395
J1104	366	J1182A	291	J1272 series	238	J1341	169
J1105B series	97	J1183 series	392-393	J1273	215	J1346 series	402
J1106 series	370	J1184	249	J1273S	215	J1350, J1350A	347
J1111	117	J1185	349	J1273W	215	J1357 series	385
J1112 series	97	J1186	340	J1275	259	J1360	180
J1113	121	J1187 series	172	J1275A	259	J1361	180
J1114R, S, T	273	J1188 series	172	J1276	260	J1362	180
J1114 series	383	J1189	184	J1276A	260	J1364 series	179
J1115	268	J1189A	184	J1277	260	J1365 series	179
J1116A-D	324	J1189 series	172	J1279 series	106	J1366	179
J1117	359	J1190 series	38	J1280	328	J1370 series	85
J1118	360	J1191	173	J1280A-D	328	J4405	268
J1119	359	J1192	173	J1281A-D	328	J4407	268
J1120	390	J1194	389	J1282A-D	350	J4411	268
J1121	390	J1195	302	J1282E	350	J6017	9
J1122	390	J1195A	302	J1283, J1283A	350	J6037	9
J1123	391	J1202	128	J1290 series	386	J6037XL	9
J1124 series	391	J1203 series	124	J1291 series	386	J7011	9
J1125 C-F	391	J1204 series	363	J1292 A, B, C	385	J7031	9
J1126	374-375	J1205 series	363	J1295	316	J7031XL	9
J1127	374-375	J1206 series	363	J1296 series	316	J7050A-E	9
J1128	374-375	J1207 series	364	J1297	106	J4153359	104
J1129	374-375	J1208 series	364	J1298	314	J428634G	104
J1130 series	366	J1209 series	364	J1298A	314	J4452557	104
J1131 series	366	J1210	192	J1299, J1299A	279	JB48080 (E-sets)	4
J1132A-K	224	J1212L, R, LA, RA, LB, RB	223	J1301 series	401	JG22 series	8
J1133A-R	224	J1214A-C, S	205	J1302 series	401	JG480 series	7
J1133	291	J1215A	223	J1304 series	401	JG482 series	7

# NOTES





# NOTES





Conversion Table French (Charriere) Gauge to Metric								
3	4	5	6	7	8	9	10	11
•	•	•	•	•	•	•	•	•
1mm			2mm			3mm		
12	13	14	15	16	17	18	19	20
•	•	•	•	•	•	•	•	•
4mm			5mm			6mm		
	22	24	26	28	30	32	34	
	•	•	•	•	•	•	•	
		8mm			10mm			
	36		38		40		45	
	•		•		•		•	
12mm			ACTUAL SIZES				15mm	

**THIS CHART IS ACTUAL SIZE**